

Proposal to the National Science Foundation for a Grant to Support

FEASIBILITY AND DESIGN STUDIES FOR A

LASER INTERFEROMETER GRAVITATIONAL WAVE DETECTION SYSTEM

to be carried out jointly by the

California Institute of Technology

and

Massachusetts Institute of Technology

TABLE OF CONTENTS

PROJECT SUMMARY	2
1. INTRODUCTION	3
PART I. - SCIENTIFIC JUSTIFICATION	6
2. THE SCIENTIFIC CASE	6
2.1. How a Laser Interferometer Gravity Wave Detector Works	7
2.2. Possible Sensitivities of Detectors in the Proposed Facilities	9
2.2.1. Sensitivities of Simple Types of First Experiments	9
2.2.2. Sensitivities of Possible Later Experiments	10
2.3. Predicted and Conjectured Source Strengths	12
2.4. Prospects for Successful Detection and Resulting Payoffs	16
2.4.1. Comparison of Detector Sensitivities and Source Strengths	16
2.4.2. Possibility of Totally Unexpected Discoveries	19
2.4.3. Testing the Laws of Physics by Gravitational Wave Observations	20
3. RECENT DEVELOPMENTS IN LASER INTERFEROMETER DETECTORS	22
3.1. The MIT Prototype Antenna	22
3.2. The Caltech Prototype Antenna	25
3.3. The University of Glasgow Prototype Antenna	28
3.4. The Max Planck / Garching Prototype Antenna	30
3.5. The CNRS / Orsay Project	31
3.6. The Leningrad and Novosibirsk Project	32
4. SOME NEW CONCEPTS FOR ENHANCING THE PERFORMANCE OF LARGE-BASELINE INTERFEROMETERS	33
4.1. Enhancement of Interferometer Sensitivity by "Light Recycling"	33
4.2. Enhancement of Interferometer Sensitivity for Periodic Signals	36
4.3. Seismic Isolation by Differential Monitoring and Coherent Driving of Test Mass Suspension Points	37
4.4. Techniques for Active Seismic Isolation of Individual Test Masses	39
4.5. An Alternative Interferometer System	40

4.6. Discrimination Against Local Disturbances by Use of Half- and Full-Length Interferometers	41
4.7. Operation of Multiple Interferometers Within a Single Vacuum System	43
4.8. Note on Overall System Outlined Here	44
5. ARGUMENTS FOR LARGE-SCALE INTERFEROMETER SYSTEMS	46
PART II. - THE PROPOSED FEASIBILITY AND DESIGN STUDIES	49
6. COST AND FEASIBILITY STUDIES FOR THE MAJOR FACILITIES OF A LARGE-SCALE INTERFEROMETER SYSTEM	49
6.1. Introduction	49
6.2. The MIT Study	51
6.2.1. The A.D. Little Study of the Vacuum System	51
6.2.2 The Stone & Webster Study of Sites	52
6.2.3. The Stone & Webster Study of Construction Strategies	53
6.2.4. The Preliminary Benchmark Design	54
6.3. The JPL/Caltech Study - An Ongoing Study for the Project	55
6.3.1. Motivation for the JPL Study	55
6.3.2. Description of the JPL Study	57
7. PLANS FOR ARRIVING AT THE FINAL CONCEPTUAL DESIGN OF THE MAJOR FACILITIES	58
8. THE ENGINEERING DESIGN STUDY AND ITS IMPLEMENTATION	60
8.1. Introduction	60
8.2. Steering Committee	62
8.3. Project Office	62
9. PROTOTYPE TESTING AND EVALUATION	69
9.1. Vacuum System Evaluations	70
9.1.1. Prototype Vacuum Systems	70
9.1.2. Tubing	72
9.1.3. Bellows, Valves, and Pumps	73
9.2. High Power Laser Contracts	75
9.3. Test Masses and Optical Systems	78

9.4. Mirrors	79
9.4.1. Fabry-Perot	79
9.4.2. Michelson	80
9.5. High Power Optical Tests	81
10. BUDGETARY ESTIMATES OF ENGINEERING DESIGN AND FEASIBILITY	
STUDIES	83
10.1. Introduction	83
10.2. Engineering Design Phase Cost Estimates	83
10.3. Proposal Budget in NSF Format	86
REFERENCES	91
VITAE AND PUBLICATIONS OF SENIOR PERSONNEL	95
R.W.P. Drever, Co-Principal Investigator	96
R. Weiss, Co-Principal Investigator	105
P.S. Lindsay	109
P.R. Saulson	112
R. Spero	115
S.E. Whitcomb	117
F. Schutz, Project Manager	122
SUMMARY OF ALL CURRENT & PENDING RESEARCH SUPPORT	129

PROJECT SUMMARY

FOR NSF USE ONLY

DIRECTORATE/DIVISION	PROGRAM OR SECTION	PROPOSAL NO.	F.Y.
----------------------	--------------------	--------------	------

NAME OF INSTITUTION (INCLUDE BRANCH/CAMPUS AND SCHOOL OR DIVISION)

California Institute of Technology	Massachusetts Institute of Technology
Division of Physics, Mathematics, and Astronomy	Division of Physics

ADDRESS (INCLUDE DEPARTMENT)

1201 E. California Blvd. Pasadena, CA 91125	Cambridge, MASS 02139
--	-----------------------

PRINCIPAL INVESTIGATOR(S)

R.W.P. DREVER	R. WEISS
---------------	----------

TITLE OF PROJECT

Feasibility and Design Studies for a Laser Interferometer Gravitational Wave Detection System

The experimental development of laser interferometer techniques for detection of gravitational radiation, together with new concepts for enhancing sensitivity, has reached a stage where interferometer systems with arm lengths of order 5 km should be capable of detection and measurement of expected gravitational wave signals from various astronomical sources. Observation of this radiation would provide new tests of general relativity theory and also lead to an important new tool in physics and astronomy, capable of giving information on collapse processes, black holes, and other astrophysical phenomena unobtainable in any other way. This joint project of the California Institute of Technology and the Massachusetts Institute of Technology will carry out feasibility studies and an engineering design study of laser interferometer detection facilities for such observations. The facilities will include large vacuum systems at two separated sites, to permit use of coincidence techniques for identifying signals, and will be sufficiently flexible to accommodate a joint Caltech-MIT gravitational wave detection system and a variety of other detectors over a long facility lifetime. The construction of these facilities will be the subject of a later proposal.

1. INTRODUCTION

Laser interferometer gravity wave detectors have been under development in a number of laboratories since 1971.¹ Now, after 13 years of prototype development and experimentation, the time has come to proceed with the feasibility studies and final design of the major facilities to house full scale detectors with sensitivities in the range of anticipated astrophysical gravity wave signals. The timeliness of such facility development is driven by the present state of the prototypes, their present rapid rate of advancement, and the realization that, even under the most optimistic of schedules, it will take four years before the full scale facilities can be ready to accept detectors.

This proposal requests funds to carry out the final engineering design of the major facilities for housing the full scale detectors. The proposal also requests funds for the prototype development and testing of components required for the facilities and receivers that influence the design of the large baseline system.

The aim of the proposed work is to establish feasibility by making detailed designs and to determine costs to enable the project to be evaluated for implementation (construction). The engineering design will use a model for the implementation plan and strategy to establish costs and schedules.

The major facilities will consist of L-shaped vacuum systems with arm lengths of order 5 kilometers and associated buildings and supporting apparatus, at two widely separated sites. Two sites are essential to the elimination of local noise which masks gravity waves; arm lengths of order 5 kilometers are essential to the achievement of sensitivities in the range of anticipated gravity wave signals.

The major facilities will be designed, constructed, and operated jointly by Caltech and MIT. Caltech and MIT will also jointly design and construct a detector system to be installed in the facilities. This detector system, consisting of a

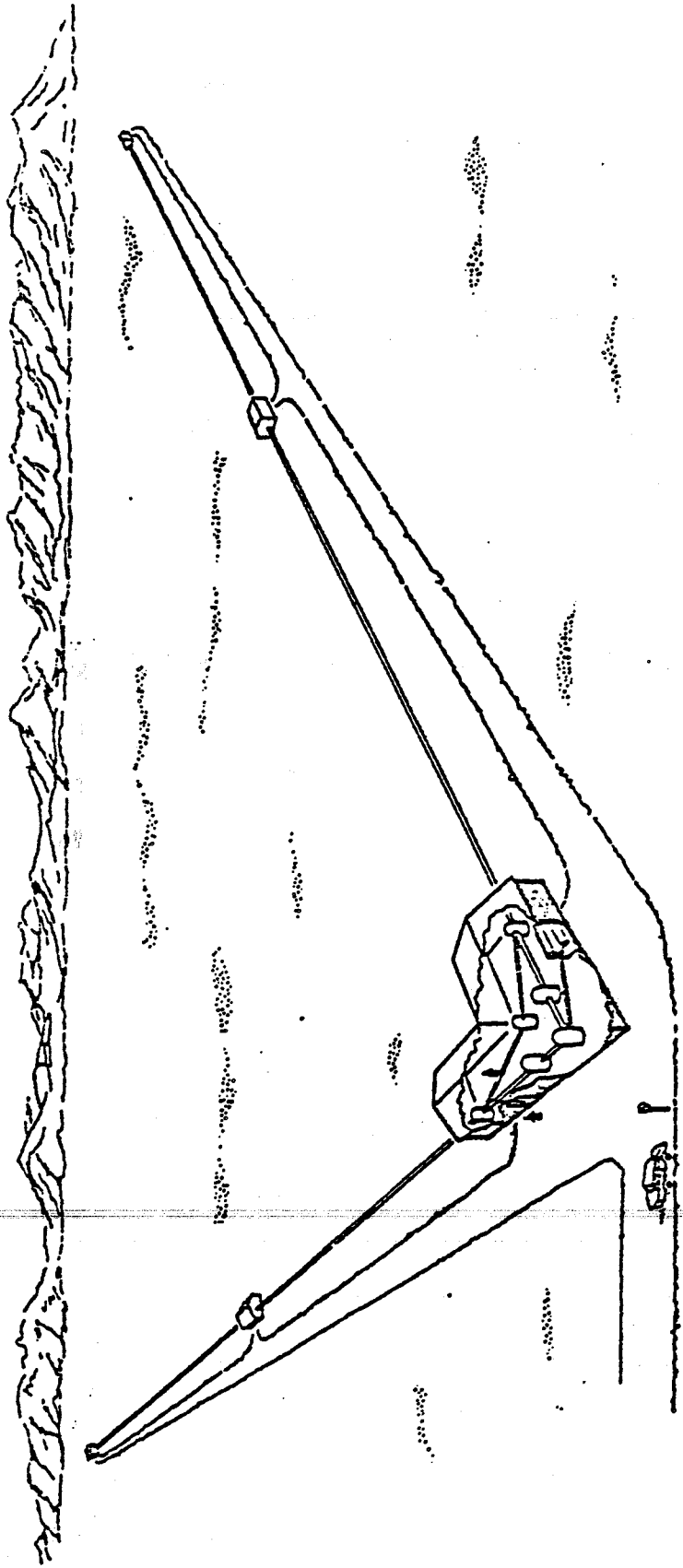

Figure 1.1 Artist's Impression of a possible type of laser gravitational wave detector discussed in this Proposal. In other variants, the vacuum pipes would be buried underground, and the central station might contain a different number of vacuum tanks--perhaps only one.

pair of gravity wave receiving systems, one at each site, with cross-correlated outputs, will be used jointly by Caltech and MIT in searches for gravity waves from astrophysical sources.

The major facilities will be designed to accommodate several detector systems simultaneously and several successive generations of detector systems over a period of perhaps 20 years. We anticipate that these other detector systems will be constructed and operated independently or jointly by scientists from Caltech and MIT, and also from other institutions.

This proposal's feasibility studies and engineering design of the major facilities will take 1 1/2 years. A second joint Caltech-MIT proposal will be submitted in January 1986 for the construction of the major facilities and the construction of the first detectors to be installed in them. The present hope is to begin construction of the facilities in October 1986 and complete them in 1988. The joint Caltech-MIT detector system would then be in operation in 1989.

The two accompanying proposals describe the work to be carried out by the Caltech and MIT research groups during the next five years on receiver development, preliminary experiments with prototype detector systems, and the design of full-scale detectors.

This proposal is divided into two parts. Part I (Sections 2 through 5) deals with the scientific justification for proceeding now with the proposed feasibility and final engineering design studies. Any reader who is already convinced of the scientific justification may wish to skim lightly over Part I and then focus on Part II, which describes the proposed feasibility and design studies and the inputs to them.

In greater detail, this proposal is organized as follows: The scientific case for a full-scale detector system is presented in Section 2; this includes a brief description of how laser interferometer gravity wave detectors work, and a

comparison of the projected sensitivities of full-scale detectors with the estimated strengths of the waves from various astrophysical sources. Section 3 describes the present state of prototype laser interferometer gravity wave detector systems in various laboratories around the world. Some new experimental techniques that could enhance the performance of full-scale detectors are described in Section 4. Section 5 presents the experimental arguments for proceeding now with the construction of the major facilities for full-scale detector systems. Section 6 describes two studies, one completed last year and the other currently underway, of the feasibility, costs, and possible sites for the major facilities. The Caltech-MIT plans for arriving at a final conceptual design of the major facilities are described in Section 7; that final conceptual design will be the starting point for this proposal's engineering design. Section 8 outlines details of the proposed engineering design study and how it will be implemented, and Section 9 describes the feasibility studies to be carried out -- the prototyping and testing of components required for the facilities and receivers, which will influence the large baseline system. Finally, Section 10 presents the budget for the proposal.

PART I. - SCIENTIFIC JUSTIFICATION

2. THE SCIENTIFIC CASE

The scientific justification for this proposal is, of course, the gravity wave experiments and observations that would be made possible by the proposed facilities. As we envision them, these experiments have excellent prospects of:

- (i). opening up a new window onto the universe, the gravitational wave window, through which may come information qualitatively different from that carried by electromagnetic waves;
- (ii). producing totally unexpected discoveries about the universe, in much the same way as radio astronomy did; and
- (iii). testing fundamental laws of physics that have never been tested before.

In Section 2.4 below we shall explain why we think the prospects for these payoffs are excellent. As foundations for our explanation, we describe in Section 2.1 how laser interferometer gravity wave detectors work, we discuss in Section 2.2 the sensitivities that might be achieved by detectors in the proposed facilities, and we describe in Section 2.3 the strengths of the gravitational waves that are predicted and conjectured to be bathing the earth. Then in Section 2.4.1 we compare the source strengths with the anticipated sensitivities and therefrom deduce that the prospects for successful detection are excellent; in Section 2.4.2 we describe the prospects for totally unexpected discoveries; and in Section 2.4.3 we describe the tests of the laws of physics that could be performed using the detectors in the proposed facilities.

2.1. How a Laser Interferometer Gravity Wave Detector Works

A gravitational wave is a propagating distortion in the metric of space time. If a beam of light makes a round-trip path between two free masses, the time it takes for the light to return to the first mass depends on the integral of the metric over its path, and thus contains a term which is proportional to the gravitational wave amplitude over its path. To exploit this effect, an interferometric gravitational wave receiver can be constructed. Schematically (Figure 2.1), it consists of three (nearly) free masses arranged in an L-shape. Light from a laser shines on a beam splitting mirror on the central mass, which directs half of the light toward each of the two end masses. Mirrors on the end masses return the light to the central mass. The polarization properties of gravitational waves are such that the changes in the round-trip travel time for light along the two orthogonal paths have opposite signs. This makes it possible to use a variety of comparison schemes to detect the effect. One simple method is to superimpose the two returning beams, forming a Michelson interferometer (Figure 2.1a). Differences in the travel times in the two arms show up as shifts in the relative phase of the two beams, and thus as shifts in the fringe at the output of the interferometer. If the gravitational wave has amplitude h , then the fractional difference in the round trip time between the two arms is equal to h .

Because the travel time difference depends on an integral over the time which the light spends in the arms, the effect grows linearly as the round trip time increases, until the round trip time becomes comparable to the period of the gravitational wave. Thus, unless the arms are already so long that one round trip time is of order the wave period, there is a benefit to increasing the total storage time of the light by folding the path of the light, allowing many round trips before making the phase comparison between the light in the two arms. One method for doing this is to make each arm of the interferometer in the form

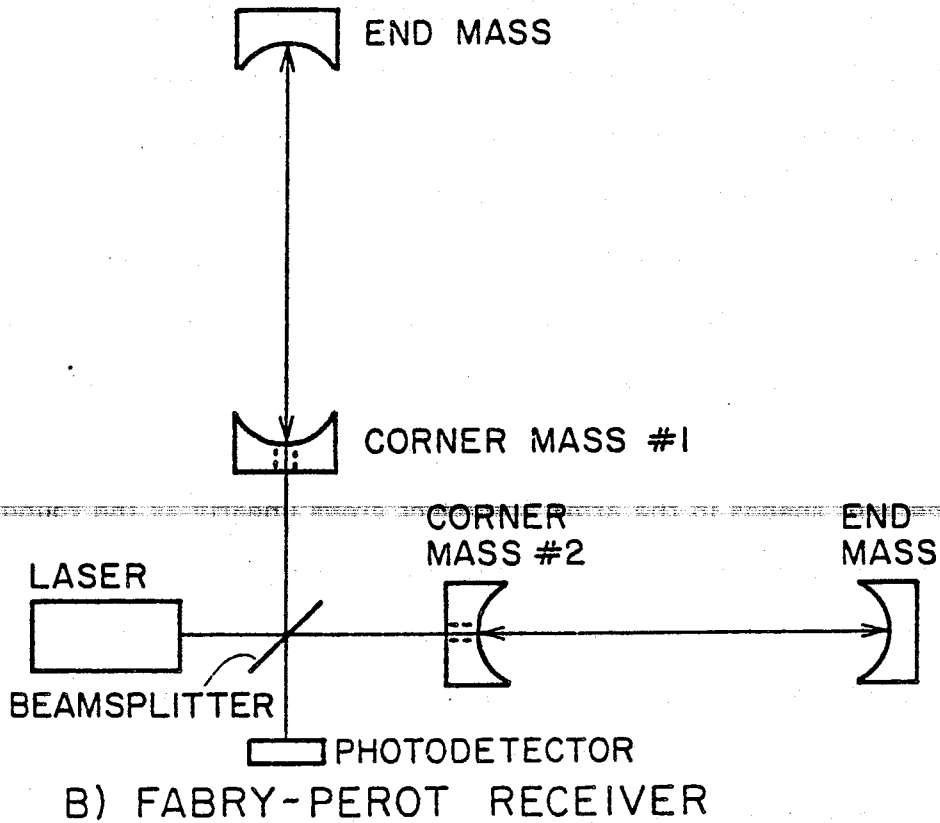
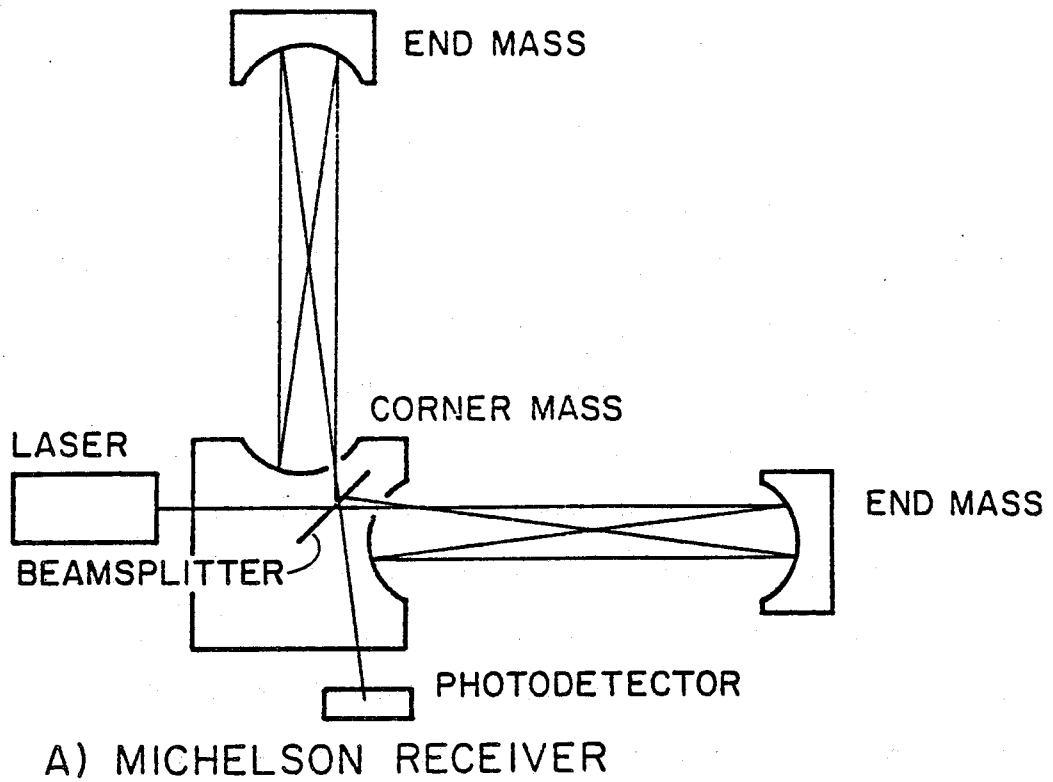

Figure 2.1 Simplified diagrams of Michelson and Fabry-Perot gravitational wave receivers. (In the lower diagram the corner mass is shown as two parts - a method for avoiding the thermal noise associated with low frequency resonances of a complex mass).

of an optical delay line of the type developed by Herriott (Figure 2.1a). In this scheme, light is injected through a hole in one mirror and makes a number of passes between the two spherical mirrors before exiting from the same hole and interfering with light from the other arm. Another method is to make each arm of the interferometer be a Fabry-Perot resonant optical cavity (Figure 2.1b). Light is injected through a partially transmitting mirror. If the length of the cavity is matched to wavelength of the light, then the phase relations between the light which has made one round trip, two round trips, and more are such that the light is effectively stored in the cavity for many round trips.

Even though the measurement is being made with light which has a wavelength of around 0.5 microns, it is possible (indeed vital) to compare the phase of the light in the two arms to a precision many orders of magnitude finer than one fringe. The fundamental limit to the precision of an interferometric measurement comes from the Poisson noise ("shot noise") in the intensity of the light at the output. Thus the precision can be made finer by increasing the illumination, until the power is so great that Poisson fluctuations in the light pressure on the end mirrors cause comparable noise.

There are of course other sources of noise which experimenters must render negligible. Most of these have the form of stochastic forces which limit the extent to which the masses in the interferometer can be considered free. The most serious of these noises, seismic vibrations and thermal (Brownian) motion, are substantially weaker at high frequencies than at low frequencies. Thus an actual gravitational wave receiver can be expected to show the ideal shot noise limited performance above some frequency (10 to 100 Hz or so), with poorer performance at lower frequencies.

A laser interferometer gravity wave detection system will typically consist of two or more receivers (like those of Figure 2.1) and associated electronics at

widely separated sites, together with the data processing system which cross correlates their outputs and searches for gravity wave signals. In this proposal we shall use the terms "receiver" and "antenna" interchangeably to mean one L-shaped interferometer system (Figure 2.1) at one site; and we shall use the terms "detector" and "detector system" to refer to the combination of receivers and data processors that are used in a gravity wave search.

2.2. Possible Sensitivities of Detectors in the Proposal Facilities

2.2.1. Sensitivities of Simple Types of First Experiments

Early gravitational wave searches in the proposed facilities, assuming arm lengths of 5 km, might involve receivers (Michelson or Fabry-Perot interferometer systems) with the following characteristics:

$$P_0\eta \equiv (\text{laser power}) \times (\text{photo detector efficiency}) = 10 \text{ Watts.}$$

$$t_{\text{store}} \equiv (\text{light storage time in interferometer}) = \frac{1}{(2 \times \text{frequency})}$$

$$b \equiv (\text{number of bounces of light}) = 30 \times (1 \text{ kHz} / \text{frequency}).$$

Seismic noise might be negligible above 1 kHz, might debilitate the performance by two orders of magnitude in amplitude at 100 Hz, and might be totally debilitating below 100 Hz.

For such gravitational wave searches the rms noise levels as functions of frequency are shown in Figures 2.2, 2.3, and 2.4 (upper solid curves). The shot noise limits of these figures were computed from the following formulae²

$$X(f) = \left[\begin{array}{c} \text{spectral density} \\ \text{of displacement noise} \end{array} \right]^{\frac{1}{2}} = \frac{\pi}{2} \left[\frac{\hbar \lambda c}{2b^2 \eta P_0} \right]^{\frac{1}{2}} \simeq 7 \times 10^{-17} \frac{\text{cm}}{\text{Hz}^{\frac{1}{2}}} \left(\frac{f}{1 \text{ kHz}} \right)$$

BURST SOURCES

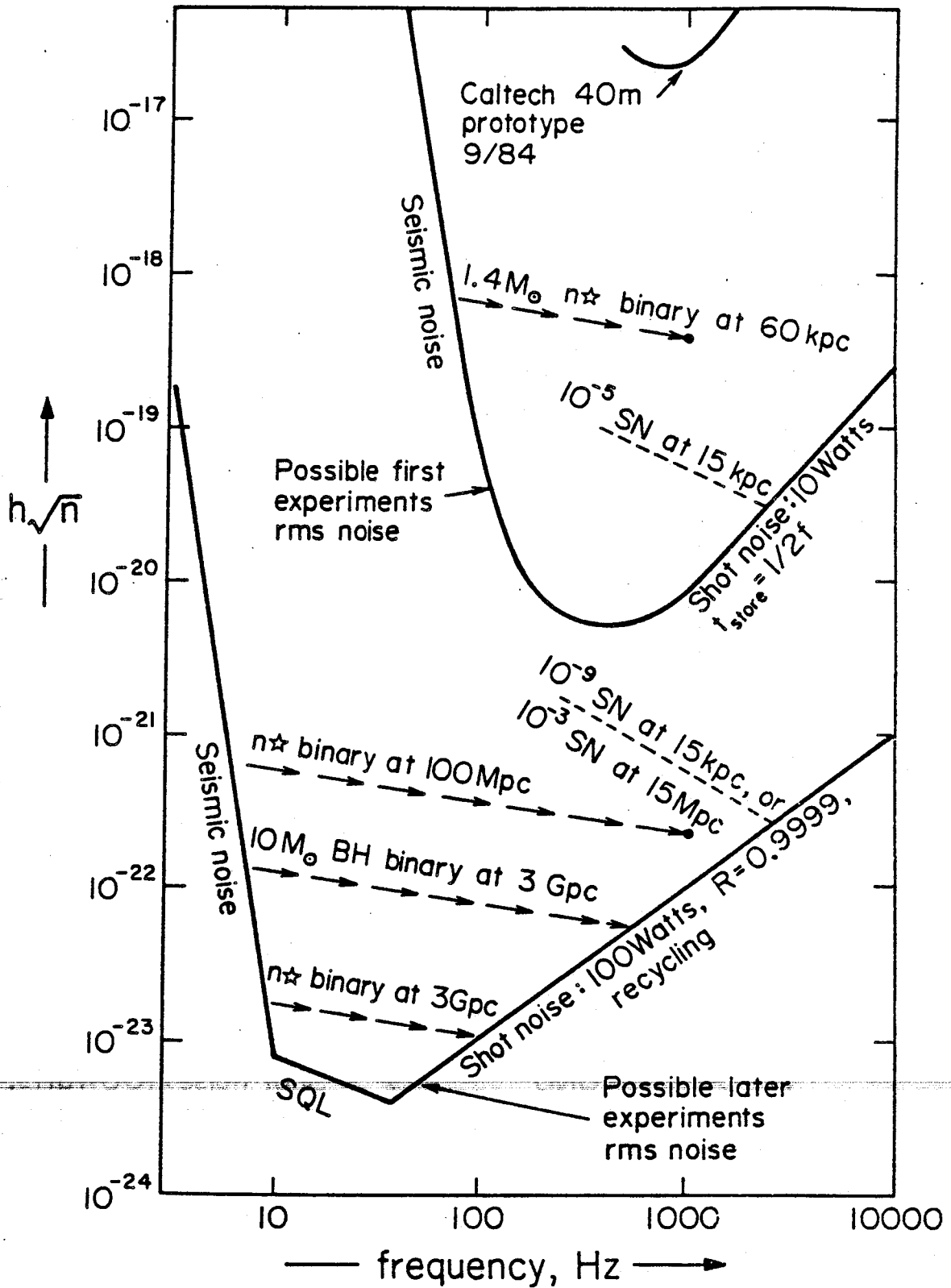

Figure 2.2 Comparison of predicted gravity wave strength for burst sources with possible detector sensitivities. See text for details about source and detector assumptions.

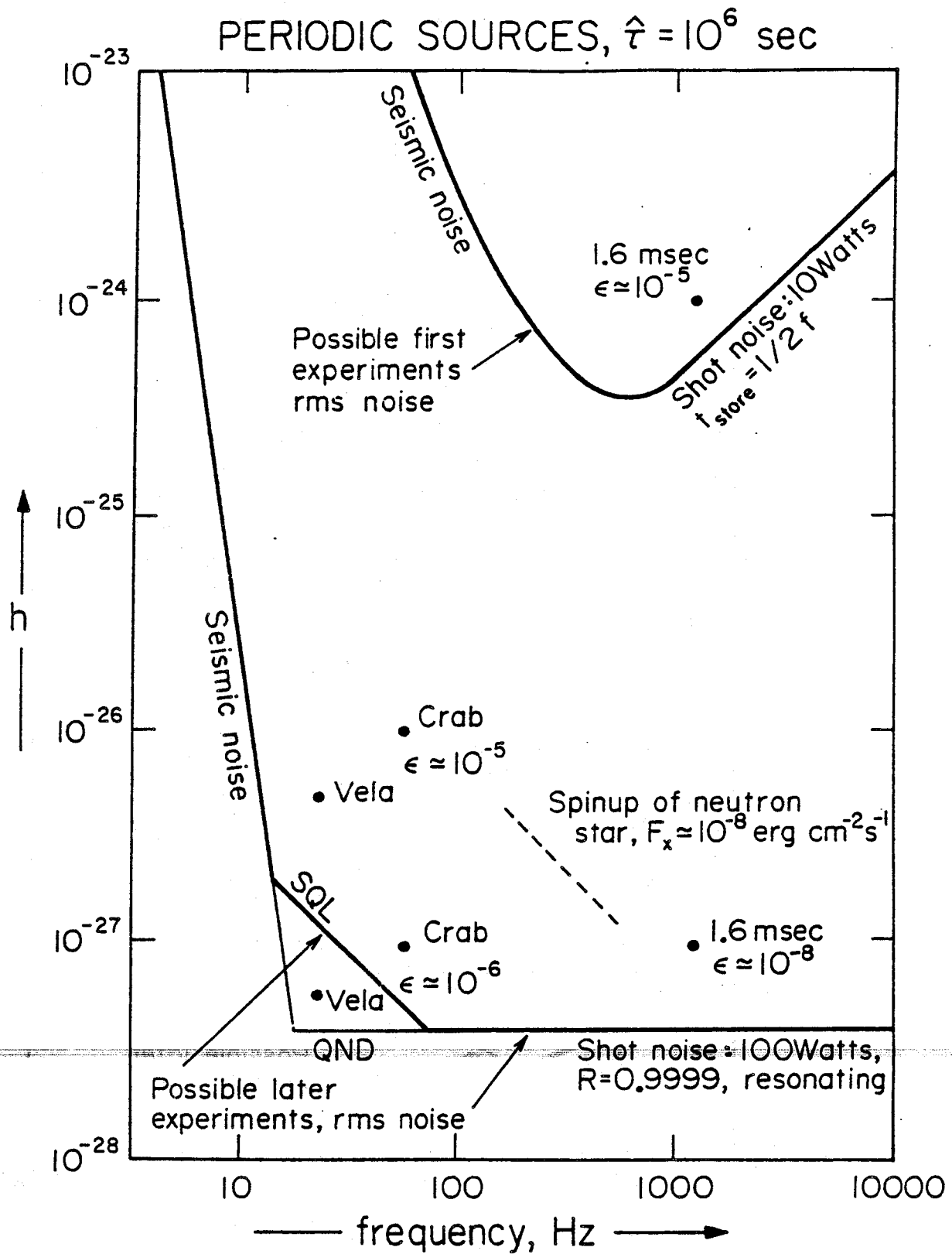

Figure 2.3 Comparison of predicted gravity wave strength for periodic sources with possible detector sensitivities. See text for details about source and detector assumptions.

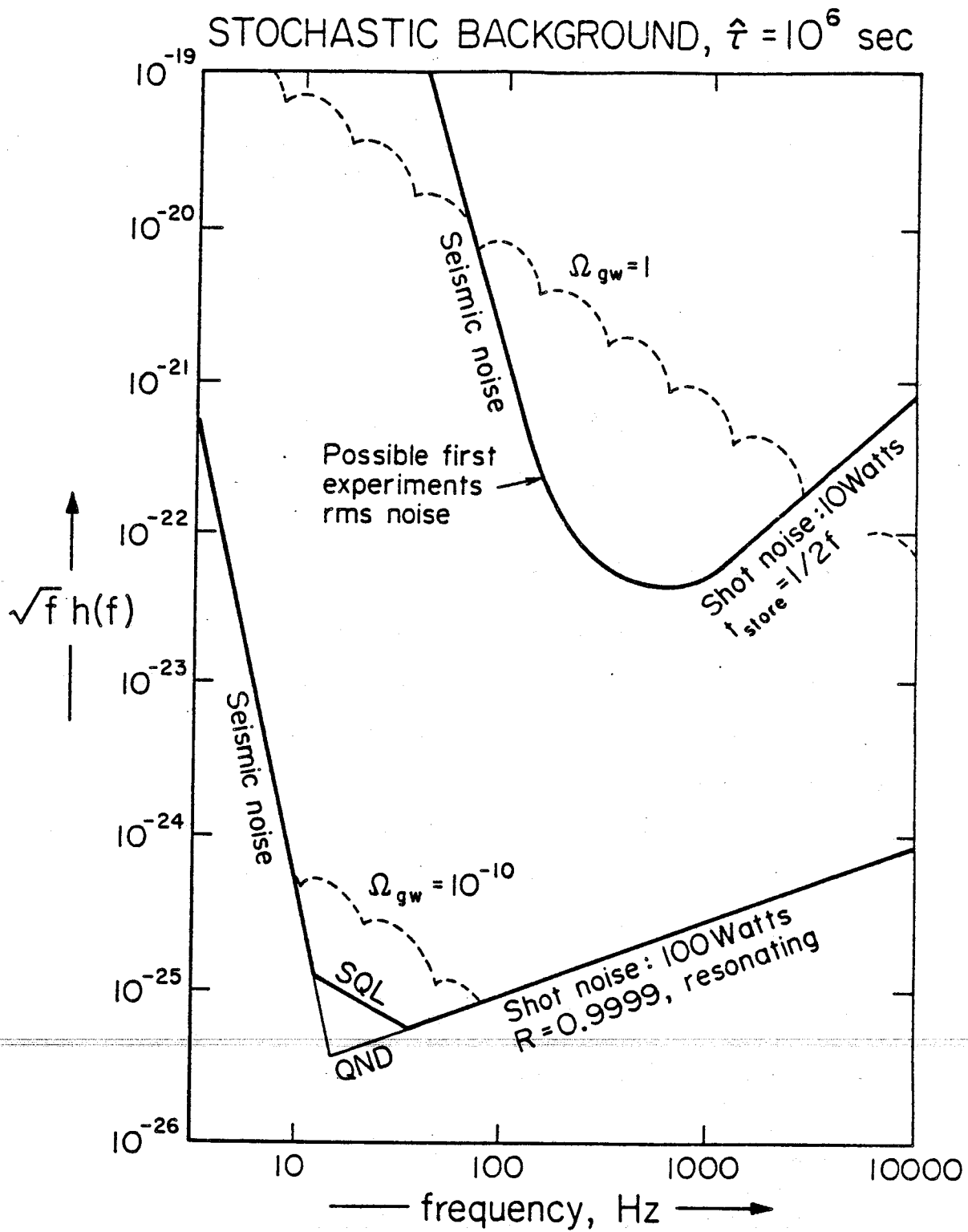

Figure 2.4 Comparison of possible strength of stochastic gravity wave backgrounds with possible detector sensitivities. See text for details about source and detector assumptions.

$$h = \frac{2}{L} \sqrt{f} X(f) \simeq 8 \times 10^{-21} \left(\frac{f}{1 \text{ kHz}} \right)^{3/2} \quad \text{for bursts of duration } 1/f,$$

$$h = \frac{2}{L} \frac{1}{\sqrt{\hat{\tau}}} X(f) \simeq 3 \times 10^{-25} \left(\frac{f}{1 \text{ kHz}} \right) \quad \begin{array}{l} \text{for periodic waves with} \\ \hat{\tau} = (\text{averaging time}) = 10^6 \text{ sec} \end{array}$$

$$\sqrt{f} h(f) = \frac{2}{L} \frac{\sqrt{f} X(f)}{(\pi f \hat{\tau})^{1/4}} \simeq 5 \times 10^{-23} \left(\frac{f}{1 \text{ kHz}} \right)^{5/4} \quad \begin{array}{l} \text{for stochastic waves with} \\ \hat{\tau} = 10^6 \text{ sec} \end{array}$$

where

$$L = (\text{armlength}) = 5 \text{ km}, \quad \lambda = (\text{wavelength of light}) / 2\pi = 0.1 \mu\text{m},$$

$$f = (\text{frequency of gravitational waves}).$$

2.2.2. Sensitivities of Possible Later Experiments

The proposed facilities will be designed to accommodate several types of gravitational wave experiments. It is impossible, of course, to say with any confidence what the most sensitive experiments will be. The best one can do is describe the most sensitive apparatus for which viable looking designs now exist. It is quite possible that the corresponding sensitivity will never be achieved, and also quite possible that it will be surpassed. The most sensitive current designs have the following characteristics:³

$$P_0 \eta = (\text{laser power}) \times (\text{photodetector sensitivity}) = 100 \text{ Watts},$$

$$R = (\text{mirror reflectivity}) = 0.9999,$$

light recycling used for burst searches,

light resonating used for periodic and stochastic searches,

seismic noise negligible above 10 Hz but debilitating below 10 Hz.

For such apparatus the rms noise levels as functions of frequency are given by the lower solid curves of Figures 2.2, 2.3, and 2.4 (labeled "possible later experiments"). The shot noise limits of these figures were computed from the following formulae³

$$h \simeq \pi \left[\frac{\hbar \lambda (1-R) f^2}{L \eta P_0} \right]^{1/2} \simeq 1 \times 10^{-22} \left(\frac{f}{1 \text{ kHz}} \right) \text{ for bursts,}$$

$$h = \frac{\pi}{L} \left[\frac{\hbar \lambda c (1-R)^2}{\eta P_0 \hat{\tau}} \right]^{1/2} \simeq 4 \times 10^{-28} \text{ for periodic waves,}$$

$$\sqrt{f} h(f) = \pi \left[\frac{\hbar \lambda c f}{\eta P_0} \right]^{1/2} \left[\frac{2(1-R)^3}{L^3 c \hat{\tau}} \right]^{1/4} \simeq 3 \times 10^{-25} \left(\frac{f}{1 \text{ kHz}} \right)^{1/2} \text{ for stochastic waves,}$$

where

$$\eta P_0 = 100 \text{ Watts, } R = 0.9999, \hat{\tau} = 10^8 \text{ sec, } L = 5 \text{ km, } \lambda = 0.1 \mu\text{m.}$$

The segments of the sensitivity curves labeled "SQL" are determined by the "standard quantum limit" for a free-mass detector -- which sets in when the stored laser power becomes so great that light-pressure fluctuations compete with photon shot noise:⁴

$$h \simeq \frac{1}{\pi L} \left(\frac{2\hbar}{Mf} \right)^{1/2} \simeq 9 \times 10^{-25} \left(\frac{1 \text{ kHz}}{f} \right)^{1/2} \text{ for bursts,}$$

$$h \simeq \frac{1}{\pi L} \left(\frac{2\hbar}{Mf} \right)^{1/2} \frac{1}{(f \hat{\tau})^{1/2}} \simeq 3 \times 10^{-29} \left(\frac{1 \text{ kHz}}{f} \right) \text{ for periodic waves,}$$

$$\sqrt{f} h(f) \simeq \frac{1}{\pi L} \left(\frac{2\hbar}{Mf} \right)^{1/2} \frac{1}{(\pi f \hat{\tau})^{1/4}} \simeq 5 \times 10^{-27} \left(\frac{1 \text{ kHz}}{f} \right)^{3/4} \text{ for stochastic waves,}$$

where

$$M = (\text{mirror mass}) = 10^6 \text{ g} , \quad \hat{\tau} = 10^6 \text{ sec} , \quad L = 5 \text{ km} .$$

For periodic and stochastic waves the standard quantum limit can be circumvented by splitting each mirror-carrying mass into two parts with a suitable spring between them.⁵ However, it is not yet clear how practical this is, so the "later" sensitivities of Figures 2.3 and 2.4 are shown both with and without the standard quantum limit. For burst waves nobody has yet devised a scheme for circumventing the standard quantum limit in laser interferometer detectors (though a potentially viable scheme does exist for bar detectors).⁶

2.3. Predicted and Conjectured Source Strengths

Figures 2.2, 2.3, and 2.4 depict the predicted and conjectured strengths of the gravitational waves from various known and hypothesized sources. The types of sources shown are the following:

Coalescence of compact binaries (neutron stars and black holes). As the two bodies in a compact binary spiral together, they emit periodic gravitational waves with a frequency that sweeps upward toward a maximum,

$$f_{\max} \simeq 1 \text{ kHz for neutron stars ;}$$

$$f_{\max} \simeq \frac{10 \text{ kHz}}{M_2/M_\odot} \text{ for holes with the larger one having mass } M_2.$$

Since the details of this frequency sweep are well known from the theory of binary stars,⁷ the experimenter can search for such sweeps in his data, thereby increasing his amplitude signal-to-noise ratio by the square root of the number n of cycles of the waves over which he observes. Since the number of cycles spent near frequency f is

$$n \equiv \frac{f^2}{df/dt} = \frac{5}{96\pi} \frac{M}{\mu} \left(\frac{c^3}{\pi GMf} \right)^{5/3} ,$$

$$\mu \equiv \frac{M_1 M_2}{M_1 + M_2} = \left(\begin{array}{c} \text{reduced} \\ \text{mass} \end{array} \right), \quad M \equiv M_1 + M_2 = \left(\begin{array}{c} \text{total} \\ \text{mass} \end{array} \right),$$

and the amplitude at that frequency, rms averaged over all detector orientations and binary orientations, is

$$h = \frac{8}{5} \frac{G\mu}{c^2 r} \left(\frac{\pi G M f}{c^3} \right)^{2/3}, \quad r \equiv (\text{distance to source}),$$

the effective signal strength is

$$h \sqrt{\pi} \simeq \sqrt{\frac{2}{15\pi} \frac{G(\mu M)^{5/2}}{c^2 r} \left(\frac{c^3}{\pi G M f} \right)^{1/6}}$$

This signal strength is shown in Figure 2.2 for several examples of compact binaries (dashed lines with arrows showing the direction of sweep of frequency). We will compare these source strengths with the detector sensitivities below. Because of their broad-band frequency sensitivities, laser interferometer detectors will be able to study the details of the frequency sweep of the waves, and the details of the final splash waves and ringdown waves produced in the coalescence. For some predictions of the characteristics of these waves, see references 8.

Supernovae. The strengths of the gravitational waves from supernovae can be characterized by the fraction of a solar rest mass of energy carried off by the waves (the "efficiency" $\Delta E / M_{\odot} c^2$):

$$h \simeq 5 \times 10^{-22} \left(\frac{\Delta E / M_{\odot} c^2}{10^{-3}} \right)^{1/2} \left(\frac{15 \text{ Mpc}}{r} \right) \left(\frac{1 \text{ kHz}}{f} \right)^{1/2},$$

$$f \equiv \left(\begin{array}{c} \text{frequency at peak} \\ \text{of spectrum} \end{array} \right).$$

If the stellar core remains nearly spherical during collapse, its efficiency will be exceedingly small; but if the core is rotating rapidly enough that centrifugal forces flatten it significantly before or by the time it reaches nuclear density, the efficiency will be 1×10^{-3} or a little larger.⁹ Figure 2.2 shows the amplitude h for examples of supernovae with various efficiencies and various distances from earth. With their broad-band capabilities, laser interferometer detectors should be able to study the detailed waveforms of the waves and thereby give detailed information about the dynamics of the collapsing (and bouncing?) stellar core. For predictions of wave forms see, e.g., references 10.

Pulsars. A pulsar (rotating neutron star) emits periodic gravitational radiation as a result of its deviations from axial symmetry. The strongest waves are likely to come off at twice the rotation frequency, though waves can also be produced at the rotation frequency plus and minus the precession frequency.¹¹ At twice the rotation frequency the amplitude of the sinusoidal waves depends on the pulsar's ellipticity ε (more precisely, the ratio ε of the nonaxisymmetric part of its moment of inertia to the axisymmetric part):

$$h \simeq 10^{-19} \varepsilon \frac{(f / 1 \text{ kHz})^2}{(r / 10 \text{ kpc})}, \quad f \equiv (\text{gravitational wave frequency}).$$

This amplitude is shown in Figure 2.3 for three known pulsars (Crab, Vela, and the "1.6 millisecond pulsar") and for various values of the unknown ellipticity. These sensitivities will be discussed below.

Spinup of a neutron star. It is fashionable to believe that the 1.6 millisecond pulsar acquired its fast rotation by spinup due to accretion in a binary system. Such spinup is subject to the "Friedman-Schutz instability",¹² wherein, when the star reaches a critical rotation rate of order that observed for the 1.6 millisecond pulsar, the bulk of the accretion energy stops spinning up the star and starts pouring out as gravitational radiation. The radiation is produced by

density waves which circulate around the neutron star's outer layers at a different speed from the star's rotation, and which thus radiate at a different, lower frequency. Wagoner¹³ has shown that the frequency of the resulting gravitational radiation will be a few hundred Hertz, and that its amplitude (which is proportional to the square root of the accretion-produced x-ray flux F_x) will be

$$h \simeq 3 \times 10^{-27} \left(\frac{300 \text{ Hz}}{f} \right) \left(\frac{F_x}{10^{-8} \text{ erg/cm}^2 \text{ sec}} \right)^{1/2}$$

This is shown in the dashed line of Figure 2.3.

Stochastic background from Population III stars. There is reason to suspect (but no guarantee) that before or near the time of galaxy formation in the expanding universe a population of massive stars formed, evolved, and died.¹⁴ These conjectured stars, called "Population III stars", may have produced in their death throes gravitational-waves that superimpose today to form a stochastic background. The strength of that background can be characterized by the frequency at which it now peaks and by the total mass-energy in it divided by the critical mass-energy that would close the universe (denoted Ω_{gw} by cosmologists). Bond and Carr¹⁴ and others have deduced from current observations and theory that Ω_{gw} cannot exceed $\sim 10^{-3}$; but values as large as $\sim 10^{-4}$ are plausible. If the waves are spread over a bandwidth of order their frequency, then the square root of the spectral density of their wave amplitude, $h(f)$, is given by

$$h(f) \simeq (6 \times 10^{-19} / \sqrt{\text{Hz}}) (1 \text{ Hz} / f)^{3/2} \Omega_{gw}^{1/2}$$

This root spectral density, multiplied by the square root of the frequency to make it dimensionless, is plotted as a series of dashed curves in Figure 2.4 for a wide range of frequencies and for Ω_{gw} equal to 1 and 10^{-10} .

Stochastic background of primordial gravitational waves. If primordial gravitational waves were in thermal equilibrium with other matter in the early universe, they today would have an energy density and spectrum similar to those of the cosmic microwave radiation -- i.e. $\Omega_{\text{gw}} \sim 10^{-4}$ and $f \sim 10^{12}$ Hz. However, the cross section for gravitational waves to interact with elementary particles is so small that they are likely to have decoupled from the primordial plasma near the Planck time and thus may never have been in thermal equilibrium with matter.¹⁵ Moreover, during the subsequent expansion of the universe they may have been parametrically amplified by coupling to the universe's background curvature of spacetime;¹⁶ and they may also have been created during the subsequent expansion by processes associated with inflation or with the decay of cosmological "strings".¹⁷ As a result, it is perfectly conceivable -- though not highly likely -- that at frequencies of interest for the proposed facilities there is a stochastic background of primordial gravitational waves as large as $\Omega_{\text{gw}} \sim 10^{-4}$.

2.4. Prospects for Successful Detection and Resulting Payoffs

2.4.1. Comparison of Detector Sensitivities and Source Strengths

When one looks closely at each source described above, one discovers the following: with a single exception (see below), either

- (i). the strength of the source's waves for a given distance from earth is uncertain by many orders of magnitude [examples: supernovae which depend on the unknown efficiency, and pulsars which depend on the unknown ellipticity]; or

- (ii). the rate of occurrence of that type of source, and thus the distance to the nearest one, is uncertain by many orders of magnitude [examples: the coalescence of binary black holes, and the spinup of neutron stars into the Friedman-Schutz regime]; or
- (iii). the very existence of the source is uncertain [examples: Population III stars, and primordial gravitational waves].

This situation has two consequences, one bad and one good: on the bad side, except for the source described below, we have no guarantees that the waves will be strong enough for detection even with the most advanced detectors yet designed -- though the prospects are promising for several of the sources. On the good side, if waves are actually detected, they will bring us qualitatively new information about the universe -- information that we are unlikely ever to obtain in any other way.

The single exception to the above is gravitational waves from the coalescence of neutron-star binaries. Clark, van den Heuvel, and Sutantyo¹⁸ have deduced, from observations in our own galaxy, that to see three such events per year one must look out to a distance of 100_{-40}^{+100} Mpc (90% confidence). Figure 2.2 indicates that with the "later" receivers, the resulting waves could be detected with an amplitude signal-to-noise ratio of 5 (the minimum needed to pull such a rare event out of Gaussian noise) out to a distance of 1.5 Gpc, i.e. half way to the edge of the observable universe. Thus, the "later receivers" would be 15 times more sensitive than needed, according to Clark, van den Heuvel, and Sutantyo, for an event rate of 3 per year; and their predicted event rate would be one per hour.¹⁸

Turn now to a detailed comparison of receiver sensitivities and source strengths, beginning with the "simple types of first experiments" to be performed in the proposed facilities. Figures 2.2, 2.3 and 2.4 reveal that these

experiments have a nonnegligible, though small chance of success: they could detect the coalescence of any neutron-star or black-hole binary in the halo of our Galaxy with a S/N of 60 or more (upper dashed curve of Figure 2.2). Such events could occur several times per year if our Galaxy's massive halo is made up of remnants of Population III stars.¹⁴ The simple types of first experiments could also detect a supernova with 10^{-5} efficiency anywhere in our Galaxy's disk with a S/N of ~ 10 (though the supernova rate is only $\lesssim 1/10$ years); they could detect waves from a 1.6 millisecond pulsar with ellipticity 10^{-5} anywhere in our Galactic disk (the known 1.6 millisecond pulsar has ellipticity 10^{-8} or smaller, but there might be a large number of other pulsars rotating this fast¹⁹ and it is conceivable that some would have ellipticities $\gg 10^{-8}$, though a recent theoretical estimate²⁰ suggests that the ellipticities may be $\lesssim 10^{-11}$); and they could place limits of $\Omega_{\text{gw}} = 0.001$ on any stochastic background in the 100 to 1000 Hz frequency band -- i.e., limits of the same magnitude as is inferred indirectly from other observations and theory.

The "advanced" detectors characterized by the lower solid lines of Figures 2.2, 2.3, and 2.4 would have an excellent chance of detecting waves and, from detailed studies of those waves, producing major new insights into the nature of the universe. With the needed S/N of 5 they could detect the coalescence of neutron-star binaries out to half the Hubble distance (1.5 Gpc) (expected event rate 1 per hour); ~~the coalescence of 10-solar mass black-hole binaries out to the~~ Hubble distance (3 Gpc); supernovae with efficiency 10^{-9} anywhere in our Galaxy; and supernovae with efficiency 0.001 at the 15 Mpc distance of the Virgo cluster of galaxies. The "advanced" detectors could also detect the Crab and Vela pulsars if their ellipticity is 3×10^{-7} or larger; the observed 1.6 millisecond pulsar, or any other such pulsar, if its ellipticity is 3×10^{-9} or larger; the spinup of a neutron star in the Friedman-Schutz regime with X-ray flux

$\geq 3 \times 10^{-10}$ erg/cm²/sec (Sco X-1 is 600 times brighter than this; many others are 10 times brighter); and a stochastic background in the 10 to 100 Hz band with $\Omega_{\text{gw}} \geq 10^{-11}$ (a factor 10^8 better than the current best limit, and a sensitivity with good prospects for detecting waves from Population III stars, if they existed).

2.4.2. Possibility of Totally Unexpected Discoveries

Until the 1930s, optical-frequency electromagnetic waves were man's only tool for studying the distant universe. The view of the universe that they gave was revolutionized by the advent of radio astronomy; and further but less spectacular revolutions were triggered by the opening of the infrared, X-ray, and gamma-ray windows.

The radio-wave revolution was so spectacular because the information carried by radio waves is so different from that carried by light. As different as radio and optical information may be, however, they do not differ as much as the information carried by gravitational waves and by electromagnetic waves.

Gravitational waves are emitted by, and carry detailed information about, coherent bulk motions of matter (e.g., collapsing stellar cores) or coherent vibrations of spacetime curvature (e.g., black holes). By contrast, astronomical electromagnetic waves are usually incoherent superpositions of emission from individual atoms, molecules, and charged particles. Gravitational waves are emitted most strongly in regions of spacetime where gravity is relativistic and where the velocities of bulk motion are near the speed of light. By contrast, electromagnetic waves come almost entirely from weak-gravity, low-velocity regions, since strong-gravity regions tend to be obscured by surrounding matter. Gravitational waves pass through surrounding matter with impunity, by contrast with electromagnetic waves which are easily absorbed and scattered, and even by contrast with neutrinos which, although they easily penetrate

normal matter, presumably scatter many times while leaving the core of a supernova.

These differences make it likely that gravitational wave astronomy will bring a revolution in our view of the universe comparable to that which came from radio waves -- though it is conceivable that we are now so sophisticated and complete in our understanding of the universe, compared to astronomers of the 1930s and 1940s, that the revolution will be less spectacular.

2.4.3. Testing the Laws of Physics by Gravitational Wave Observations

Detailed studies of cosmic gravitational waves are likely to yield experimental tests of fundamental laws of physics which cannot be tested in any other way.

The first discovery of gravitational waves would verify the predictions of general relativity (and other relativistic theories of gravity) that such waves should exist.

By comparing the arrival times of the first bursts of light and gravitational waves from a distant supernova, one could verify general relativity's prediction that electromagnetic and gravitational waves propagate with the same speed -- i.e., that they couple to the static gravity (spacetime curvature) of our Galaxy and other galaxies in the same way. For a supernova in the Virgo cluster (15 Mpc distant), first detected optically one day after the light curve starts to rise, the electromagnetic and gravitational speeds could be checked to be the same to within a fractional accuracy $(1 \text{ light day}) / (15 \text{ Mpc}) = 2 \times 10^{-11}$.

By measuring the polarization properties of the gravitational waves, one could verify general relativity's prediction that the waves are transverse and traceless -- and thus are the classical consequences of spin-two gravitons.

By comparing the detailed wave forms of observed gravitational wave bursts with those predicted for the coalescence of black-hole binaries (which will be

computed by numerical relativity in the next few years,²¹⁾ one could verify that certain bursts are indeed produced by black-hole coalescences -- and, as a consequence, verify unequivocally the existence of black holes and general relativity's predictions of their behavior in highly dynamical circumstances. Such verifications would constitute by far the strongest test ever of Einstein's laws of gravity.

3. RECENT DEVELOPMENTS IN LASER INTERFEROMETER DETECTORS

The first experimental work on laser interferometer gravitational wave detectors was carried out at Hughes Research Laboratories and MIT in the early 1970's;¹ but the present vigorous efforts at Munich, Glasgow, Caltech and MIT did not get underway until the late 1970's. To give a picture of the current situation we will now summarize the recent work by the groups that are currently active.

3.1. The MIT Prototype Antenna

The prototype laser interferometric antenna at MIT²² (Figure 3.1) is a Michelson interferometer with 1.5 meter arms in which the beams are folded to increase the light storage time. The antenna is operated to hold a single fringe by means of feedback to optical and mechanical controllers. The feedback signal is the antenna output.

A schematic of the interferometer is shown in Figure 3.2. The interferometer mirrors are attached to masses suspended on pendulums with periods of 2 seconds. At frequencies large compared to the pendulum resonance frequencies, the masses are free in inertial space and isolated from external acoustic and seismic perturbations. Capacitive displacement sensors for all six degrees of freedom of each of the three masses are used to drive electrostatic controllers to critically damp the pendulums without adding noise in the gravitational frequency band. The interferometer is operated in a vacuum of 10^{-6} torr, maintained by ion pumps, to reduce gas pressure fluctuation forces on the masses and index of refraction changes in the optical paths.

On entering the vacuum, the light is split by a 50/50 beam splitter and then enters the interferometer arms through holes in the mirrors. The light traverses each arm 56 times and reemerges through the same hole by which it entered. The multipass geometry, formed by spherical mirrors, is called a

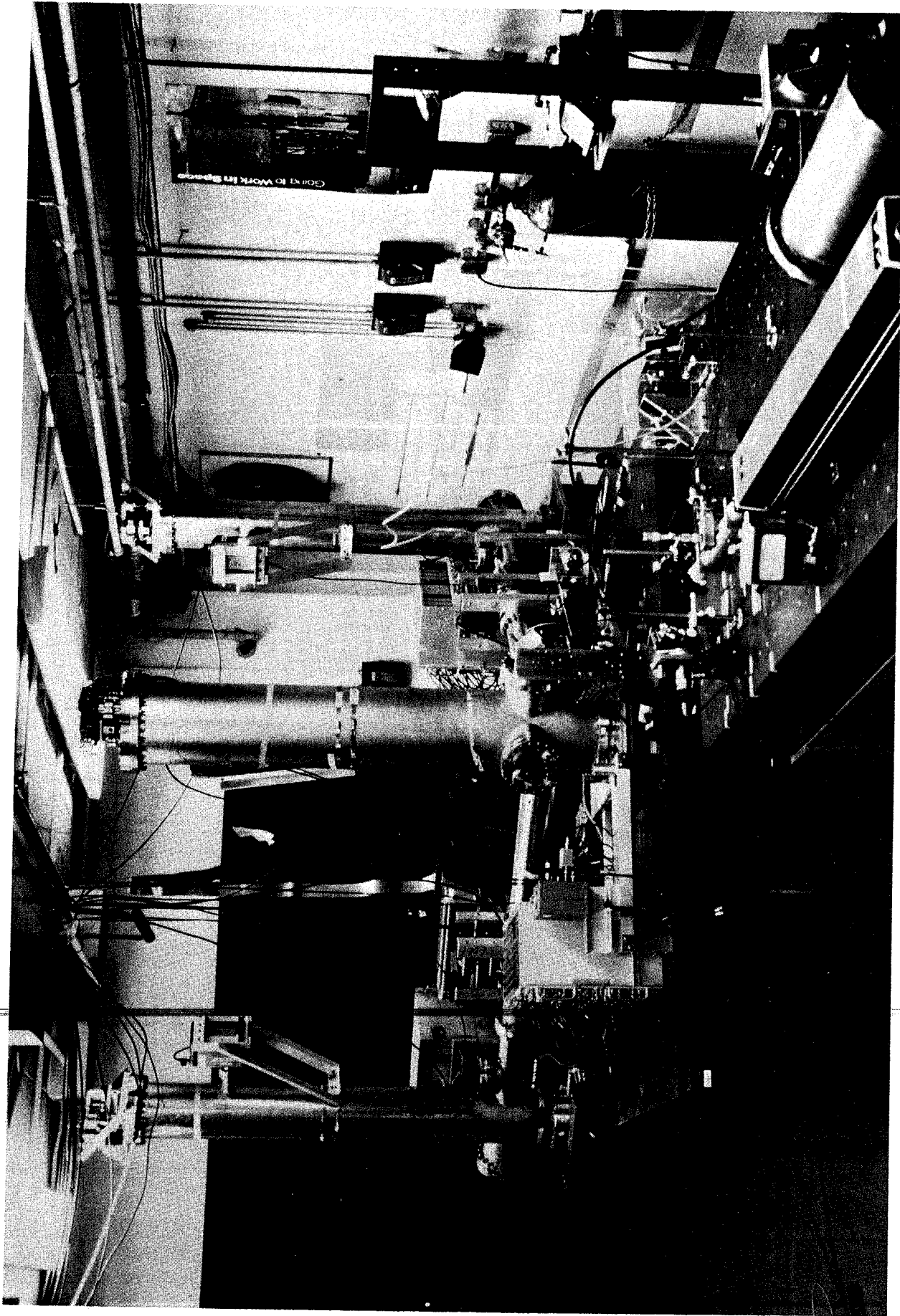
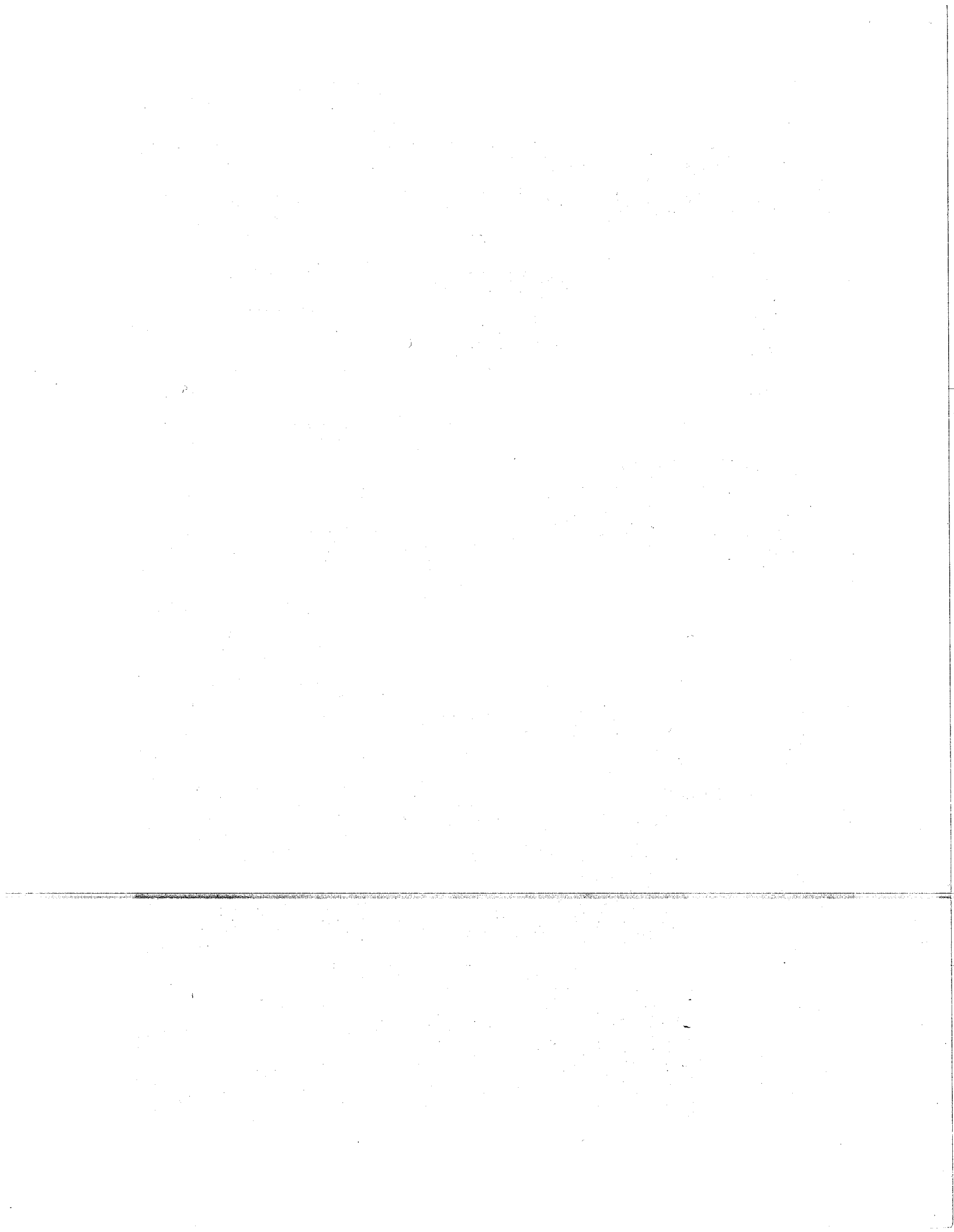

Figure 3.1 The MIT Prototype Antenna



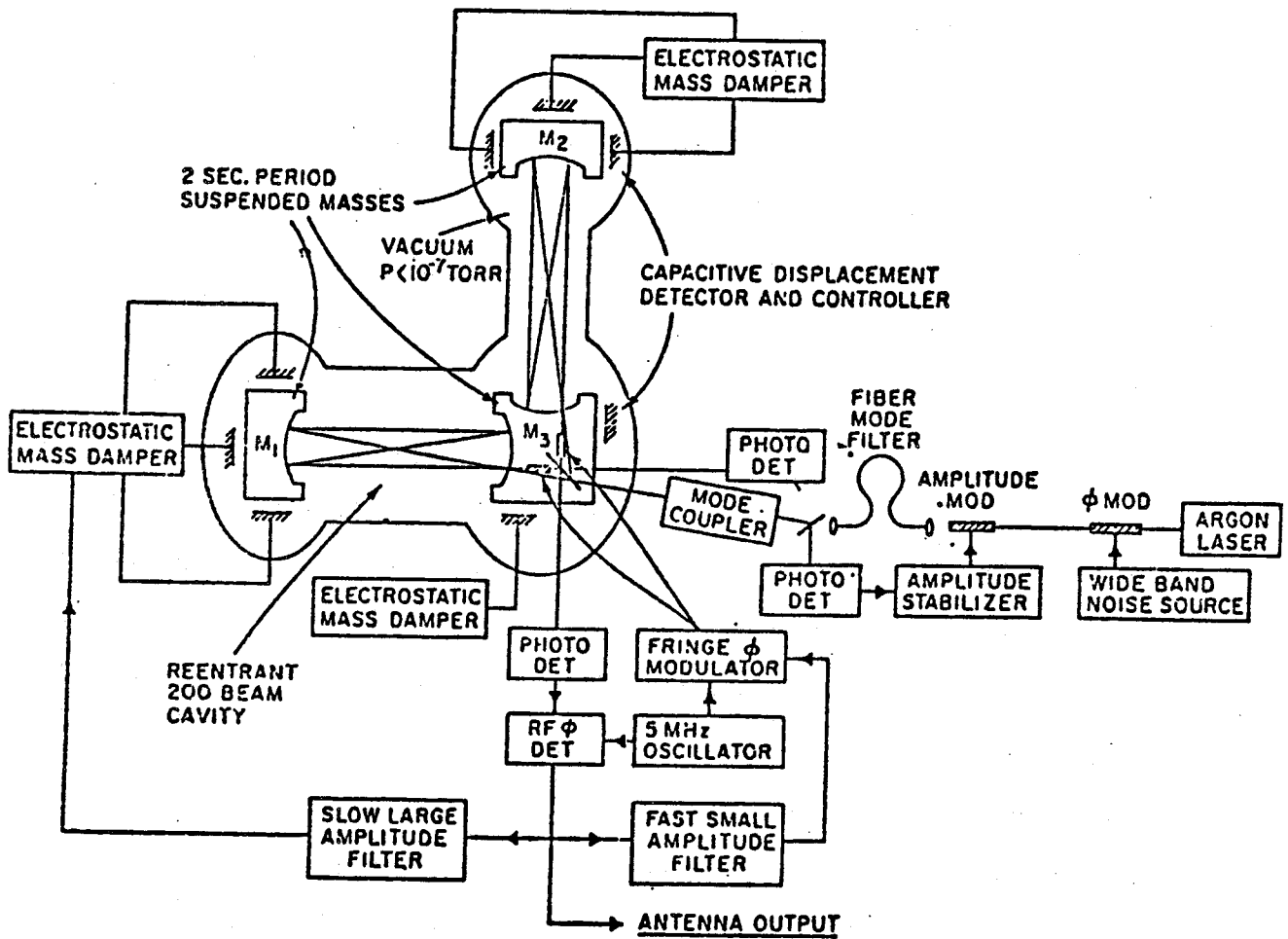

Figure 3.2 Schematic diagram of the MIT prototype antenna.

Herriot delay line. The number of beam transits is determined by the mirror radii and their separation. When properly aligned, the optical path length in the arms is first-order sensitive to mirror displacements along the optic axis and second-order sensitive to all other motions. After leaving the delay line the light passes through electro-optic phase modulators (Pockel's cells), one in each arm, and is then recombined. Both the symmetric and the antisymmetric outputs are measured on photodetectors.

In order to determine the fringe motion a 5.3 MHz phase modulation is impressed on the light beams by the electro-optic modulators. When the interferometer is at a symmetry point of a fringe, the photodetector output contains signals at even harmonics of this frequency. If the fringe moves from the symmetry point, the photocurrent contains a signal at the fundamental with amplitude proportional to the fringe motion and phase determined by the direction. These signals after synchronous detection and filtering are returned to the electro-optic phase modulators and the mass electrostatic controllers to hold the interferometer on a fixed fringe. The fringe interrogation scheme serves to move the fringe signals above the $1/f$ noise in the laser amplitude, amplifiers, and photodetectors. The technique of locking to a fringe suppresses the effect of gain variations and laser amplitude fluctuations. It furthermore enables the interferometer to operate near the condition for equal optical path length in the two arms, which is required to reduce the noise due to laser frequency fluctuations.

The light source is a 1/4 watt argon-ion laser operating in a single mode at 5145 Angstroms. After the light leaves the laser its instantaneous line width is broadened to a Lorentzian line of about 1 GHz width using an electro-optic modulator driven by wide band Gaussian or periodic random noise. The frequency broadening suppresses the interference modulation of the main beam in

the interferometer by scattered light. The scattered light will generally have taken different times than the main beam to reach the output of the interferometer. Due to the frequency broadening the interference between the scattered light and the main beam will undergo rapid phase fluctuations which result in an amplitude noise spectrum that can be made as small as the shot noise in the scattered intensity. The technique requires that the interferometer be held near the zero path length difference fringe. The precision of the path length equality is determined by the amount of scattering.

The laser light is injected into the interferometer by way of an assembly of spatial mode matching lenses and a single mode optical fiber. The fiber, a few meters long, serves to isolate the laser's mechanical noise from the interferometer. More importantly, it reduces the noise from laser beam position and angle fluctuations that would be converted to phase fluctuations at the output of the interferometer due to imperfect alignment of the instrument. The residual amplitude noise produced by the fiber can be removed by an amplitude stabilization servo. At present, however, this does not appear necessary.

The performance of the instrument (July 1984) is shown in Figure 3.3. The displacement noise at frequencies above 5 kHz is $3 \times 10^{-15} \text{cm}/\sqrt{\text{Hz}}$ with 13 mW of power modulated by the interferometer. The idealized shot noise limit for this power and a light storage time of 0.28 microsec (56 passes in 1.5 meters) is $2 \times 10^{-15} \text{cm}/\sqrt{\text{Hz}}$. The excess noise at frequencies below 5 kHz is accounted for by acoustic and seismic noise coupled through the simple pendulum suspension. At present the suspension is a single 1/4 inch diameter aluminum rod attached directly to a flange at the top of the vacuum enclosure.

DL1:JUL17H.DAT, Time 24:29:39

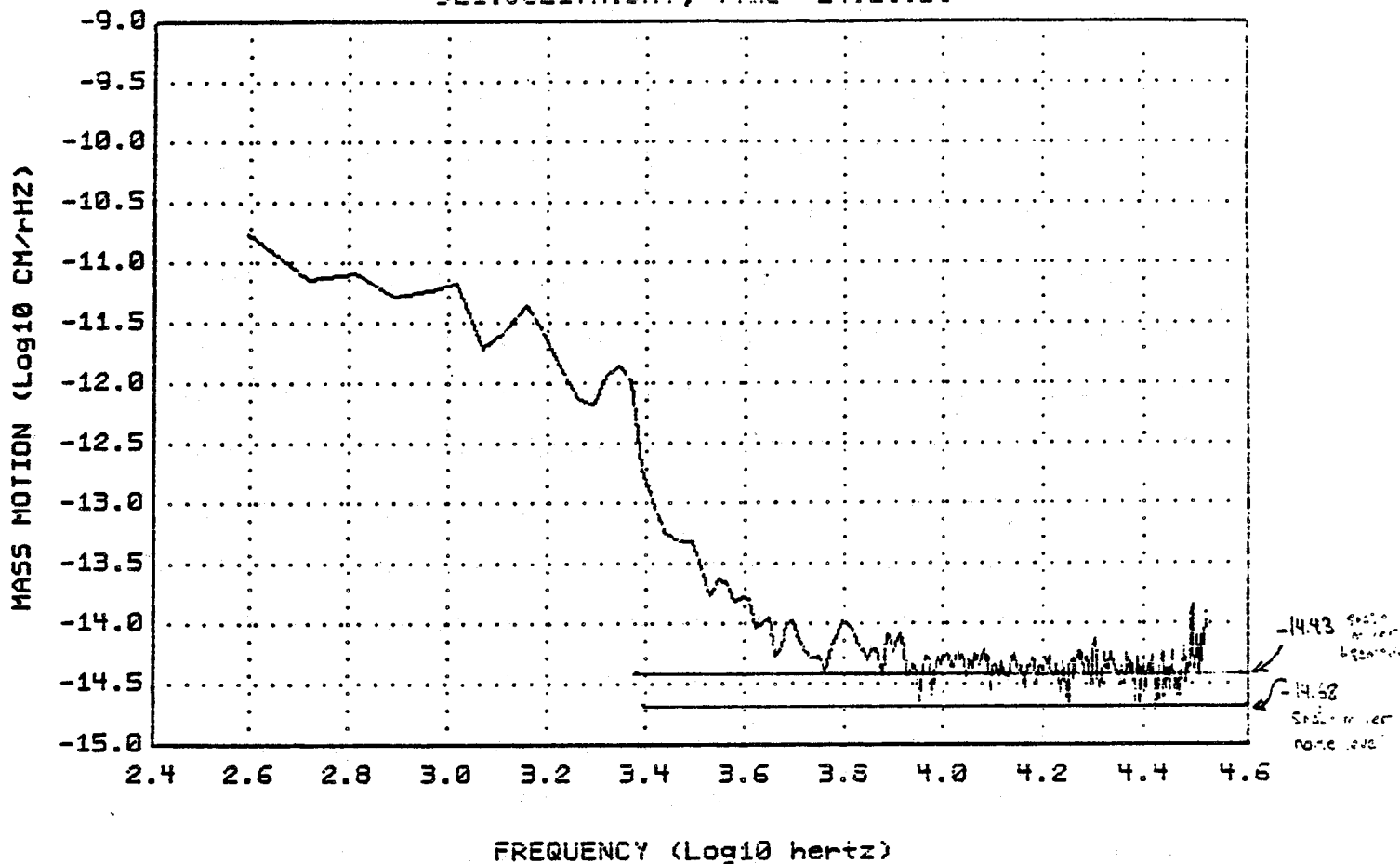

Averages: 4; Points: 256; Apodization: Hanning
Omega Symm. As in 'G.DAT except 47.80 MHz 1 dB Digimod.
AC on. 2444. VPR eff, 13 mW average power. Delta=.80

Figure 3.3 Recent noise spectrum of the MIT prototype antenna. The sensitivity is near the shot noise limit above 4 kHz. At lower frequencies the excess noise is due to seismic and acoustic noise coupling through the suspensions.

3.2. The Caltech Prototype Antenna

The Gravitational Physics group at Caltech was started in 1979 when one of the P.I.'s of the present proposal took up a post there. The initial experimental work grew out of earlier work on laser interferometers for gravitational wave detection at the University of Glasgow. Experiments began with the construction of 10-meter long Fabry-Perot cavities and the development of laser stabilization techniques,²³ followed by construction of a full prototype laser interferometer gravitational wave detector with arms 40 meters long in a specially designed building. Most of the Caltech experimental work has been carried out with the latter instrument, which we now describe.²⁴ The accompanying Caltech 5-year proposal contains additional details.

The Caltech prototype antenna (Figure 3.4) consists of two similar 40-meter long Fabry-Perot cavities arranged in an L. The cavity mirrors are affixed to 10 kg masses suspended by wires; the masses are free to respond to impulses fast compared to the one-second pendulum period of the masses. Light from an argon-ion laser of wavelength 514 nm enters the antenna at the corner of the L, where it is split between the two cavities. An incident gravity wave changes the length of the two arms differently, and alters the optical phase difference between the two cavities. The phase difference as monitored by photodetectors is proportional to the gravity wave signal.

~~The corner vacuum chamber houses three separately suspended masses--a~~ large aluminum disc and two identical compact brass cylinders, horizontally suspended and capped with planar high-reflectivity mirrors. The disc is centered in the vacuum chamber and supports a beam splitter and assorted steering optics, including beam splitting polarizers and quarter-wave plates to deflect the cavity light into photodetectors. Vacuum chambers at the ends of the L each house one mirror-bearing mass similar to the corner masses. The end mirror

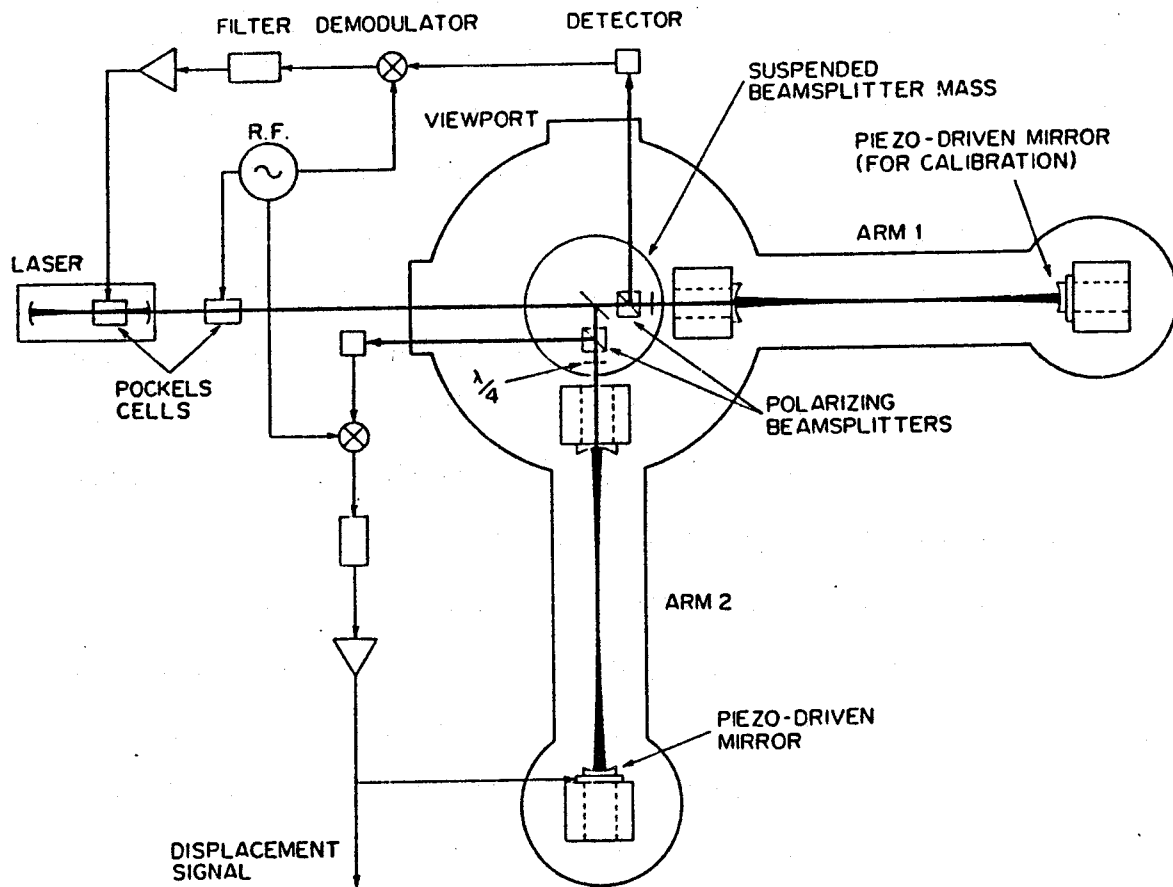

Figure 3.4 Schematic diagram of the Caltech 40 m prototype as of September 1984. The interferometer uses five suspended masses inside the vacuum chamber -- four to carry the mirrors which define the ends of the two arms and one to carry the beamsplitter and associated optics. An rf phase modulation technique is used to lock the laser frequency to the first arm, while the second arm is locked to the laser frequency using a piezoelectrically driven mirror. The gravity wave signal appears as a voltage applied to the piezo-mirror to compensate for the difference in arm lengths caused by the wave.

surfaces are ground to a curvature radius of 62-meters and coated for the highest possible reflectivity. Piezoelectric transducers between the mirrors and masses are used to fine tune the cavity length and to calibrate the gravity wave detector.

The optical paths between the cavity mirrors are evacuated to 2×10^{-3} torr. Stainless steel pipes of 20 cm diameter span the distance between cavity mirrors (see Figure 3.5). Flanges are joined with metal seals; by adding pumps the detector can operate at much lower pressure if performance becomes limited by effects of residual gas.

In operation, phase sensitive servos keep the two cavities in resonance. An electro-optic cell applies phase modulation at radio frequency to the light before it enters the cavities. The light reflected directly off of the input cavity mirrors has sidebands due to the modulation, but the sidebands are stripped off the light which is stored in the narrow bandwidth (200 Hz) cavities. The phases of the stored and reflected pieces of light incident on the photodetector are compared, and the difference signal controls the frequency of the laser and lengths of the cavities to maintain resonance.

Low-frequency control of the orientation and longitudinal position of the masses is provided by multi-wire suspensions. Mass orientation is monitored by 40-meter long optical levers which use the cavity mirrors to reflect beams from ~~low-power He-Ne lasers onto position-sensitive photodiodes.~~ The signals from these photodiodes are attenuated at frequencies below 100 Hz and fed back to magnetic transducers which exert forces near the top of the suspension wires, controlling the angular degrees of freedom of the masses to within a microradian. Low-frequency longitudinal motion is monitored by the phase of the resonant cavity light and by separate LED-photodiode shadowmeters mounted below each test mass; feedback signals to keep the cavities in resonance are

applied to large-range Piezoelectric transducers at the top of the suspension wires.

Several stages of seismic isolation are used, beginning with isolated concrete pads anchored to piles extending approximately five meters below floor level before contacting the ground. The vacuum chambers containing the masses rest on vibration-damped optical tables, and are isolated from the 40-meter pipes by flexible bellows. A four-layer stack of alternating lead and rubber inside the vacuum isolates against seismic disturbances above the stack's resonance frequency of approximately 5 Hz. The Caltech group estimates that the passive isolation in conjunction with the wire suspension provides adequate attenuation to prevent seismic or acoustic noise from limiting performance at frequencies above 100 Hz.

The principal sensitivity goal of the Caltech prototype development is to achieve shot-noise limited performance in the region of 1 kHz with high-reflectivity mirrors and high laser power. The mirrors now installed (loss = 4×10^{-5}) will potentially exhibit minimum shot noise at all frequencies above 200 Hz. Mirrors with higher reflectivity will not be needed until advanced optical schemes (such as light recycling) are employed.

Present performance is indicated in Figure 3.6, which shows the frequency spectrum of the noise output of the Caltech prototype interferometer, calibrated in m/\sqrt{Hz} (to convert to h/\sqrt{Hz} , divide by 40 meters). Also shown is the theoretical performance, limited only by photon shot noise. The shot noise calculation, based on 1 mW of light power incident on each photodiode and 50% quantum efficiency, was checked by an independent calibration of the system response. The observed noise is within a factor of two of shot noise at frequencies above 800 Hz. Near 1 kHz the displacement sensitivity is $2 \times 10^{-17} m/\sqrt{Hz}$, and the strain sensitivity is $5 \times 10^{-19}/\sqrt{Hz}$. Investigations are currently

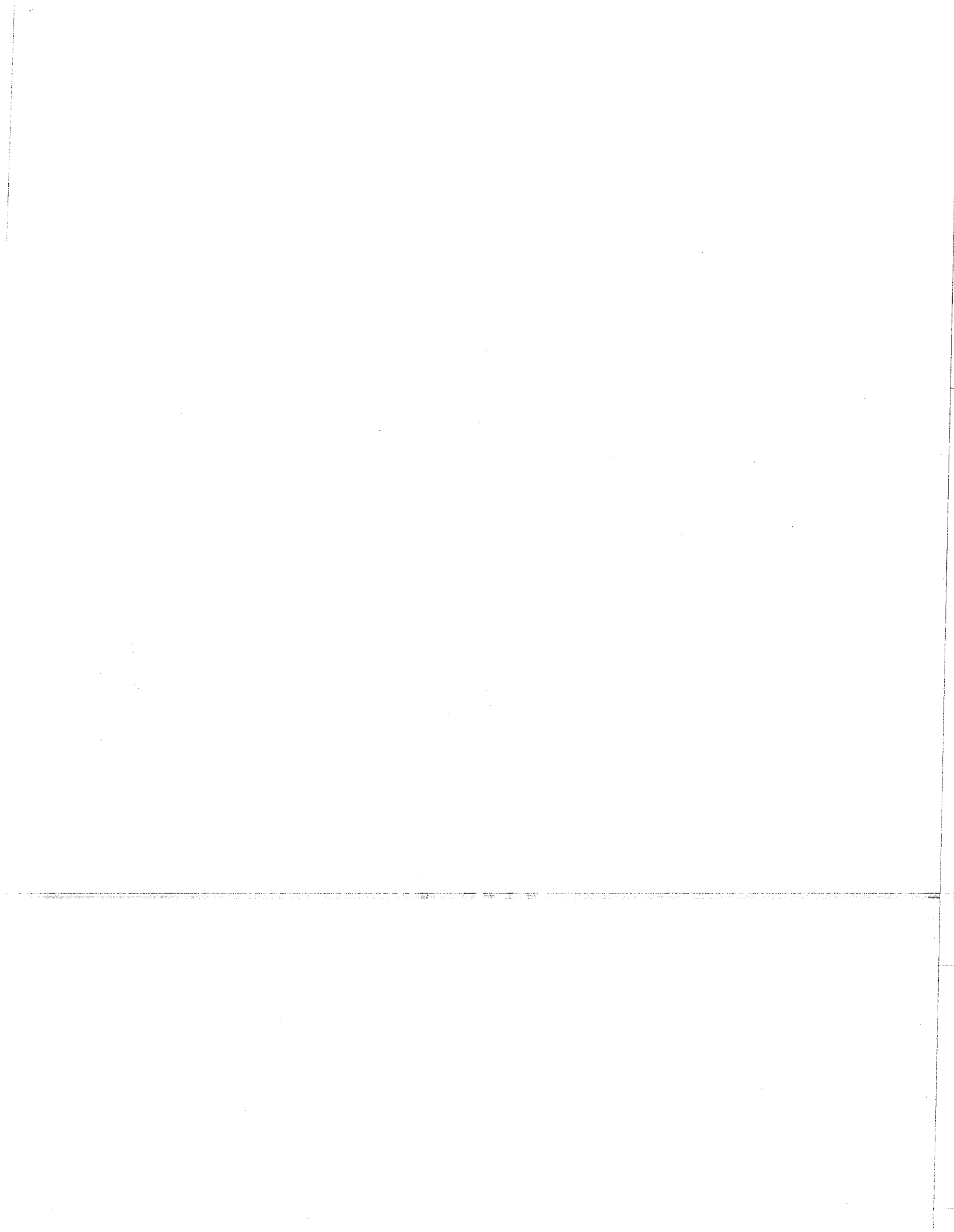
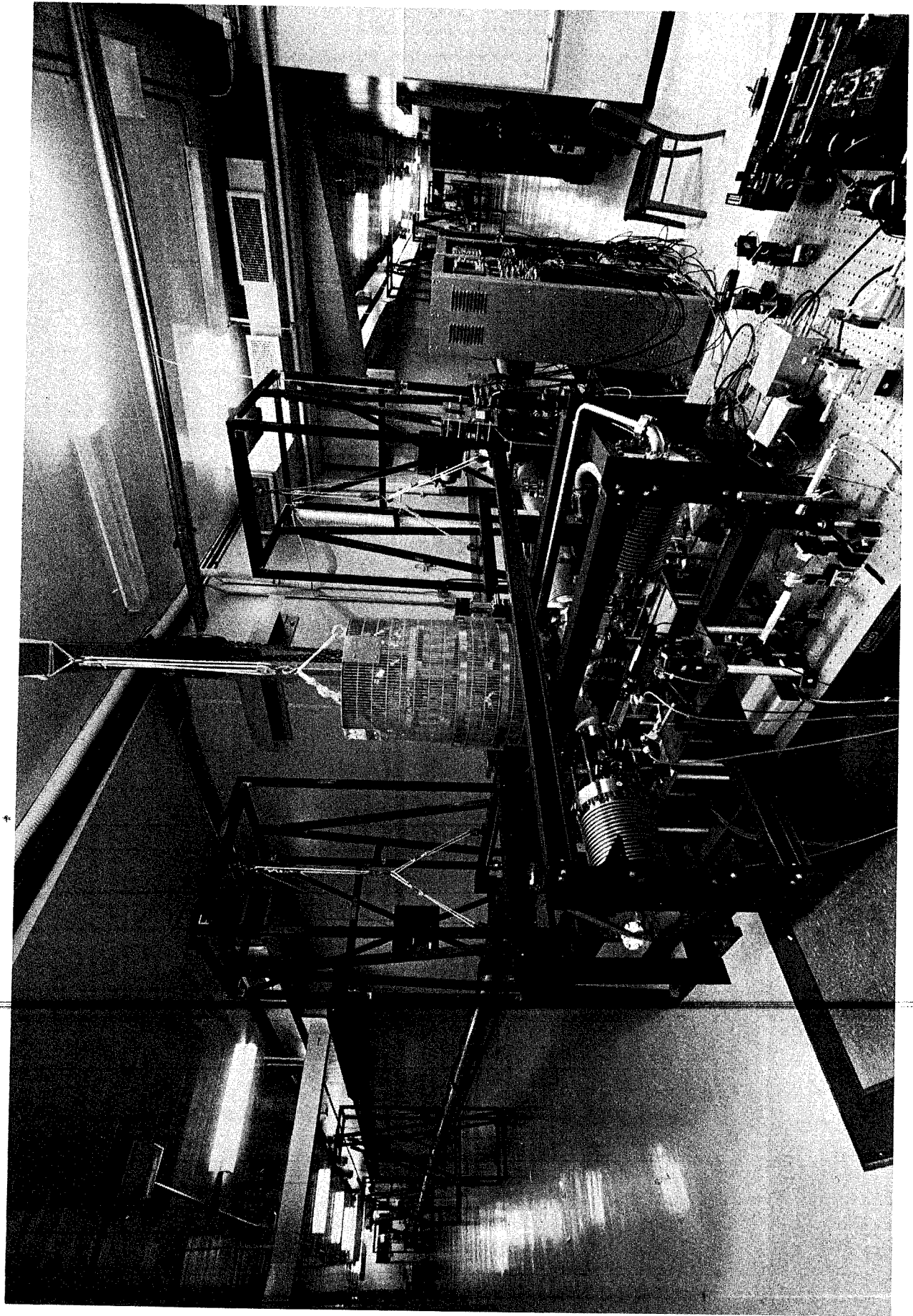
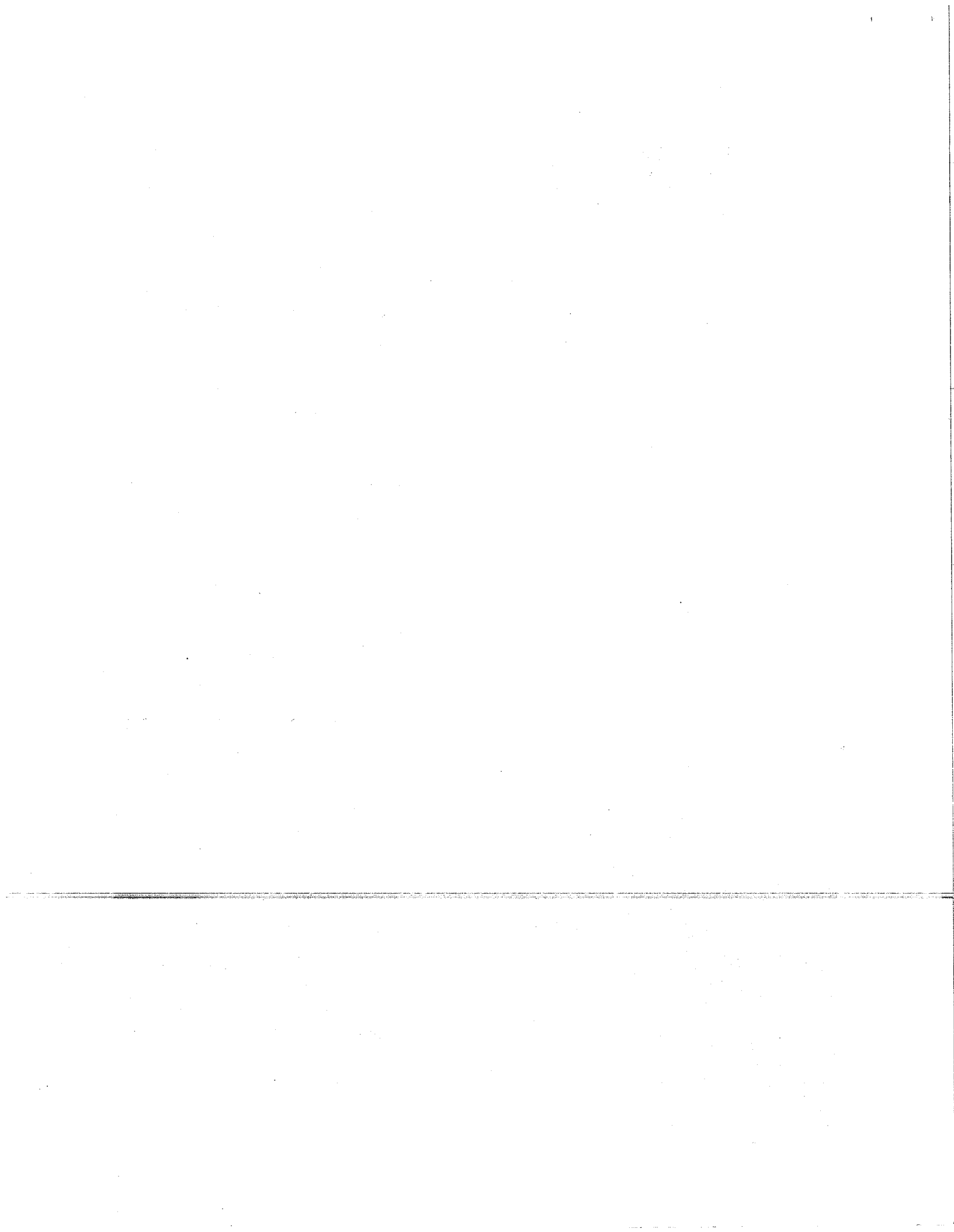

Figure 3.5 View of Caltech 40-meter laser interferometer gravitational wave detector, as of October 1984. Other parts of the optical system, and associated electronics, extend off the right hand side of the photograph. (This photograph was taken with an ultra-wide-angle lens, to show both arms of the interferometer. It may be viewed in correct perspective by placing the eye, aided by a lens of power about 6 diopters, 10 cm from the page.)





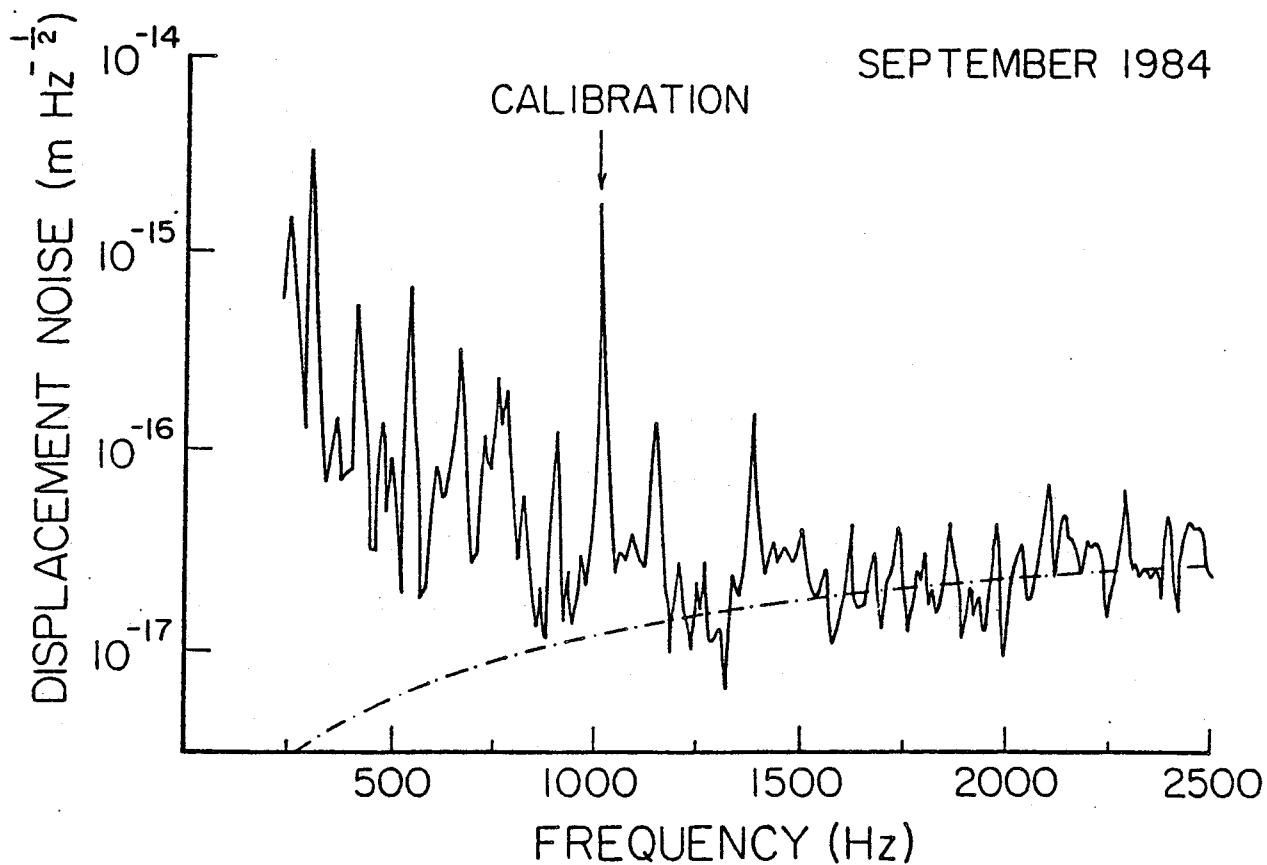

Figure 3.6 Noise spectrum of the Caltech prototype antenna. This noise spectrum, taken in September 1984, is expressed as an equivalent difference in arm lengths for the two arms. To convert this to a gravity wave strain sensitivity ($\text{Hz}^{-1/2}$), divide by the arm length of 40 m. The dashed curve shows the calculated shot noise for the light power (2 mW) and fringe visibility (0.65) of the interferometer at this measurement. The portion of the spectrum below 250 Hz was not well calibrated in this measurement and has been deleted. Many of the peaks below 1 kHz are multiples of the line frequency and may be due to pickup in the electronics.

underway to determine the source of excess noise below 800 Hz. Also underway are efforts to reduce the noise level near 1 kHz and above by coupling more light into the interferometer; with the present laser, the effective light power can be increased by as much as a factor of 100.

Several recent changes in the design of the prototype have been responsible for the improved spectrum of Figure 3.6. The laser has been rebuilt to isolate its mirrors from vibration due to the cooling water; tests indicate a substantial improvement in laser frequency stability. The cavity mirrors now in place give an optical storage time of 0.7 milliseconds -- 30 times greater than the storage time available five months ago. The current system of five separately suspended masses is a recent improvement over a three-mass system, in which the corner mass supported cavity mirrors as well as the beam splitter. The old masses exhibited low-frequency resonances; replacing them with the stiffer and smaller masses now in use was key to achieving the present performance. Some of these changes followed similar developments on the 10 meter antenna at the University of Glasgow, and indeed from the start Caltech has benefited from a strong and continuing collaboration with the Glasgow group.

3.3. The University of Glasgow Prototype Antenna

Experimental work on gravitational wave detection began at Glasgow around 1970, with development of wide band resonant bar gravitational wave detectors by one of the present P.I.'s and colleagues. Extensive coincidence pulse²⁵ and cross correlation²⁶ searches were made with a pair of detectors, which recorded one possibly interesting pulse signal in two years of operation. Efforts then shifted to development of laser interferometer detectors, initially with a 1-meter prototype detector²⁷ using multireflection Michelson interferometer optics, built with 0.3 ton test masses and the isolation and vacuum system

of an earlier "divided-bar" gravitational wave detector. Much work on high-Q suspensions and electrostatic feedback systems was done, and noise studies showed up the importance of scattering at the multireflection mirrors. The Fabry Perot-gravitational wave detector system was devised at this point,²⁸ primarily to avoid the scattering problems of delay lines, and the second Glasgow interferometer, with 10-meter Fabry-Perot cavities, was built.

The technique of laser stabilization by monitoring the phase of light reflected from an optical cavity was devised in this work, and developed both at JILA (Colorado) and with this 10-m interferometer.²³ Design of test masses has gone through three generations with this apparatus, the current test masses being simple bronze spheres with inset mirrors supported by 4-wire suspensions from tilting, rotating, and translating control blocks driven by electromagnetic and piezoelectric transducers. At the central station a separately suspended and servo-controlled structure supports the optics for splitting, recombining, and controlling the main beams, including Pockels cells, polarizers, position-sensitive photodiodes, and a separate "mode-cleaning" optical cavity for reducing geometrical fluctuations in the laser beam. The position and direction of the input laser beam is controlled by auxiliary servo systems using fast and slow piezo-driven mirrors.

Commercially available mirrors with relatively large losses are currently used in this interferometer, but until recently the sensitivity achieved²⁹ (Figure 3.7) has been better than that of any other Fabry-Perot system, and is essentially at the photon shot noise limit for the mirrors and the light power used at all frequencies between 500 Hz and 10 kHz. It has currently been overtaken by the Caltech 40-m interferometer, however, with the installation of mirrors having losses lower by two orders of magnitude in the latter instrument.

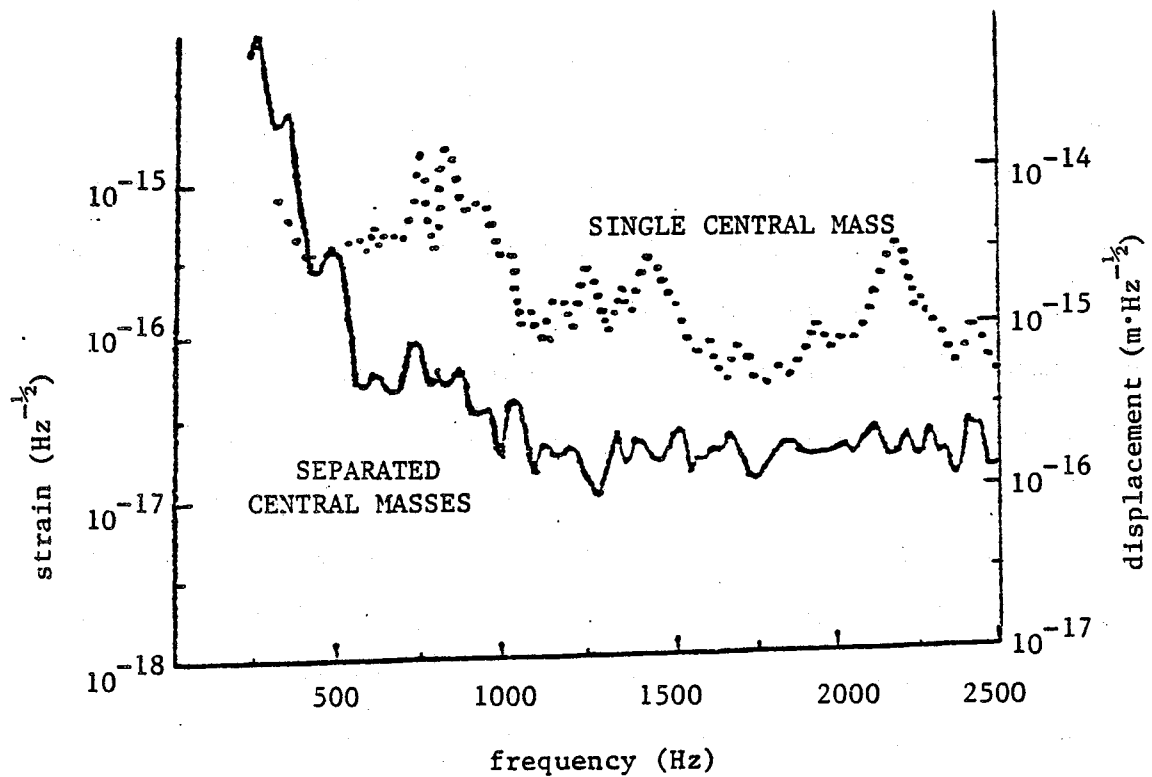

Figure 3.7 Noise spectra of the Glasgow 10 m prototype antenna. These spectra, which are calibrated in both strain ($\text{Hz}^{-1/2}$) and in displacement ($\text{m} \cdot \text{Hz}^{-1/2}$), show the improvement obtained by placing the cavity mirrors on separate, low-noise masses.

A considerable amount of experimental and theoretical work on active seismic isolation techniques has been done at Glasgow (see Section 4.4). This led to an actively-isolated and servo-stabilized test mass at the end of one cavity of the 10-m interferometer, with tilt isolation using a freely suspended reference arm. Active seismic isolation has not been applied to the other test masses in the system, however, although active feedback damping is used for all of the masses.

Recent work at Glasgow includes development of a laser stabilization technique aimed at giving maximum continuous power from a high-power argon laser. To avoid the losses and damage experienced with electro-optical devices in the laser cavity a high-speed piezo mirror developed by the Orsay group provides first-order stabilization, with subsequent phase correction by a Pockels cell outside the laser. Results are encouraging.

There is close collaboration between the Glasgow and the Caltech groups, and as the Glasgow interferometer project began several years earlier than the Caltech one many of the relevant techniques have been developed first there. By concentrating efforts on slightly different aspects in the two groups a very beneficial collaboration has been achieved, and, it is hoped, will continue.

3.4. The Max Planck / Garching Prototype Antenna

The group at the Max Planck Institute in Garching was the first to achieve displacement sensitivity in the $10^{-17} \text{m Hz}^{-1/2}$ range. Their antenna,³⁰ like the MIT antenna, is a multipass Michelson. The principal differences are the scale of the apparatus, the use of a frequency stabilized laser to solve the scattered light problem, and of an in line Fabry-Perot cavity ("mode cleaner") to eliminate the angular and position jitter of the laser beam. Their first antenna was a 3 meter, 138 beam system with 25 mW of effective laser power. A new interferometer with

30 meter arms and similar design has now come into operation.³¹ This was the first instrument to implement the idea, suggested from Caltech,³ of dividing the central mass into separate parts in order to decouple the mechanical resonances of optical mounts and motors from the multi pass optical mirrors. For the same reason, the end masses consist of the end mirrors themselves.

The 30 meter antenna currently has a displacement sensitivity of $1.5 \times 10^{-15} \text{ cm Hz}^{-1/2}$ at all frequencies above 1 kHz (Figure 3.8).³¹ This is within a factor of 2 of the shot noise limit of the system with 50 mW of interferometrically modulated power and 50 passes of the beam per arm. In a 30 meter baseline the sensitivity translates into a rms h of $\approx 10^{-17}$ for a 1 kHz bandwidth, sensitivity equal to the best of the room temperature acoustic devices.

3.5. The CNRS / Orsay Project

A new group in gravity wave detection has just started at CNRS/Orsay in France under the leadership of Alain Brillet. This group has not yet settled on the design of an interferometer. They are currently investigating the technology of generating high laser power in a single line. Using an Ar⁺ laser they have succeeded³² in generating 1.5 Watts at a wavelength of 488.0 nm with the technique of "injection locking". A low power phase stabilized master laser is used to mode lock a high power slave laser. The outputs are in phase and can be coherently added. This can be generalized to multiple slave lasers all locked to the same master and added coherently to produce a high power (100 Watt) beam. This technique has several advantages over a single high power laser: frequency stabilization is only needed on a low power laser; there is no need to develop a high power laser, current 20 Watt lasers can be used; and the redundancy makes it more reliable. The loss of a single laser is not catastrophic since several others will still be operating.

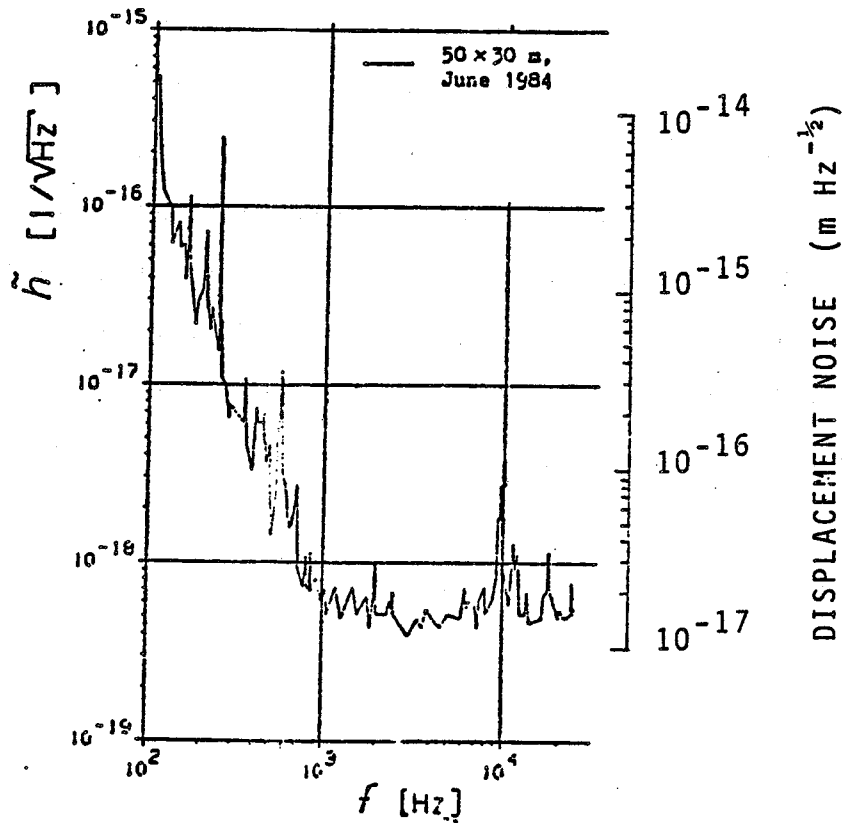

Figure 3.8 Noise spectrum from the MPI/Garching 30 m prototype antenna.³¹
 The spectrum is calibrated in both strain (Hz^{-1/2}) and displacement (m Hz^{-1/2}).
 The antenna is shot noise limited between 1 and 10 kHz.

3.6. The Leningrad and Novosibirsk Project

A laser interferometer gravity wave detector project was initiated in Leningrad in 1976 by Erast Gliner,³³ but it did not get strong support from Soviet authorities until 1979, after Gliner had applied to emigrate to the United States and had left the project. At that time it was restructured under the leadership of I.M. Belousova of the State Optical Institute in Leningrad³⁴ with an annual budget which, we are told by Soviet colleagues, was of order a million rubles (1.3 million dollars) per year. Rumor has it that the project has not been going well and has recently been restructured once again, but no official information about this is available. Independently of this Leningrad effort, V.P. Chebotaev, a highly respected laser spectroscopist at the Institute of Thermophysics in Novosibirsk, has initiated a more modest effort on laser interferometer gravity wave detection;³⁵ but the present state of his efforts is not known in the West.

4. SOME NEW CONCEPTS FOR ENHANCING THE PERFORMANCE OF LARGE-BASELINE INTERFEROMETERS

The large-scale interferometric gravitational wave detectors which we are proposing to construct are the next stage in the work of the Caltech and MIT groups whose prototype antennas have been described above. Many of the techniques for the large-scale detectors are extensions of those that have been tested and demonstrated in the prototypes. The new factors will be the larger scale of the optical components, the smaller angles involved, and the higher light power being projected. The development of this technology will be one of the major efforts in the research groups during the next few years.

In this section of the proposal we describe some other techniques, not at present incorporated in the prototypes, which are likely to prove useful in large-scale detectors. Although success of these techniques is not essential to the first experiments with our large-baseline antennas, their promise of enhancing the large antenna performances is sufficiently great that some of them will be the subject of major research efforts in the next few years.

4.1. Enhancement of Interferometer Sensitivity by "Light Recycling"

The limits to the sensitivity of laser interferometer gravitational wave detectors set by photon shot noise have been summarized in the first chapter of this Proposal. For simple delay line or Fabry-Perot interferometers the sensitivity is proportional to $(\text{light power})^{-1/2}$. We plan to use laser powers of some tens of watts, being limited at present by availability of suitable continuous wave lasers capable of giving the required highly stable output. To increase sensitivity further and make possible detection of signals over a larger region of the range of expected amplitudes some new methods for improving interferometer efficiency have been conceived in the course of the Caltech work.³ These depend

on the fact that when the interferometers are operated close to a dark fringe in the output - with minimum light intensity on the final photodiode - very little light is actually consumed in the measurement. In fact most of the input light is either wasted in optical losses of various kinds or is rejected by the system. For example, in a simple Michelson interferometer with path differences adjusted for minimum light on the photodiode most of the light emerges from the interferometer from the other side of the beam splitter, and is wasted. It is proposed that this light be re-used, by feeding it back to add coherently to the input light from the laser. One way of doing this is illustrated, in principle, in Figure 4.1. Here the laser beam enters the system through a mirror of carefully chosen transmission, with the fed back light added at this mirror. In effect, the extra mirror turns the whole system into a large Fabry-Perot cavity, and with correct adjustment of wavelength or optical path differences a large buildup of light flux may be achieved within the interferometer, giving a corresponding improvement in sensitivity. Adjustment of the phase of the recycled light may readily be made automatic by monitoring the phase of light reflected back from the recycling mirror, using the high frequency phase modulation techniques already developed in this work for locking the frequency of a laser to an optical cavity resonance.

The same basic idea may be applied also to Fabry-Perot interferometers. In a gravity wave detector based on optical cavities, the reflectivity of the back mirror in each cavity would normally be made as high as possible and the input mirror in each arm would have lower reflectivity, chosen to give a storage time for the light within the cavity appropriate for the period of the gravitational waves of interest. Under these conditions, with low-loss mirrors, most of the light incident on each cavity will be reflected back and will contribute to the rejected light emerging from the unused side of the main beam splitter. It is

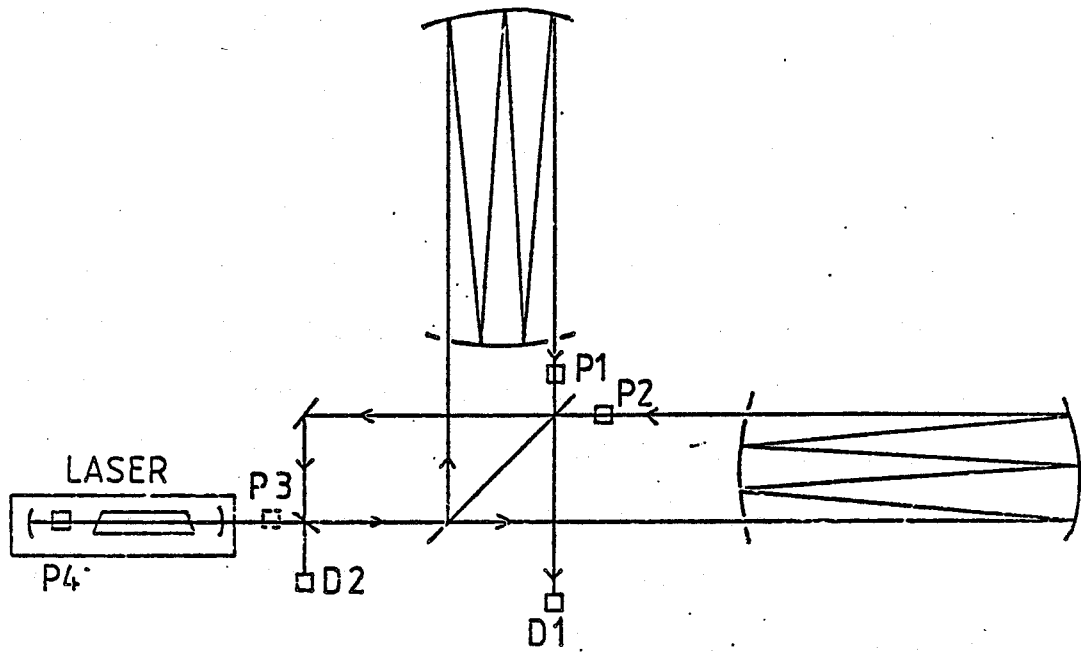

Figure 4.1 Possible method for enhancing the sensitivity of a delay line antenna using recycling.

proposed that this light be returned to the system by an extra mirror of suitably chosen reflectivity in the initial laser beam, as indicated in Figure 4.2. As in the case above, this forms a larger Fabry-Perot cavity around the whole interferometer system, giving in principle a useful buildup in light intensity if phases and reflectivities are correctly arranged.

The improvements in sensitivity achievable with these recycling schemes depend on the optical losses in the main parts of the interferometer. Multilayer dielectric mirrors with losses as low as 1 part in 10,000 have been developed for applications in laser gyroscopes, and special mirrors of this type have been tested and used in the Caltech 40 meter interferometer. However other optical elements, such as Pockels cell modulators, have at present much larger losses. Designs for practical recycling systems have therefore been devised at Caltech in which electro-optical modulators are kept out of the sensitive part of the interferometer, and the radio frequency modulation useful for low noise phase measurement is achieved by mixing a separately modulated external beam with the interferometer output, as indicated schematically in Figure 4.3.

The increase in effective light power obtainable by these recycling systems is given approximately by the ratio of the total storage time achieved to the storage time in each arm. In a search for millisecond pulses with a large interferometer, this factor could lie between 100 and 1000, giving the significant improvements in potential sensitivity quoted earlier in Section 2.2.2.

It may be noted that the minimum gravity wave pulse energy detectable in a recycling interferometer system at the photon shot noise limit is proportional to the ratio of mirror losses to arm length (cf. Section 2.2.2). In view of the present estimates of and uncertainties in gravitational wave strengths (Section 2.3), it will be important to have both very large arm lengths and very low losses. This indicates why the recent development of low loss gyro mirrors is so

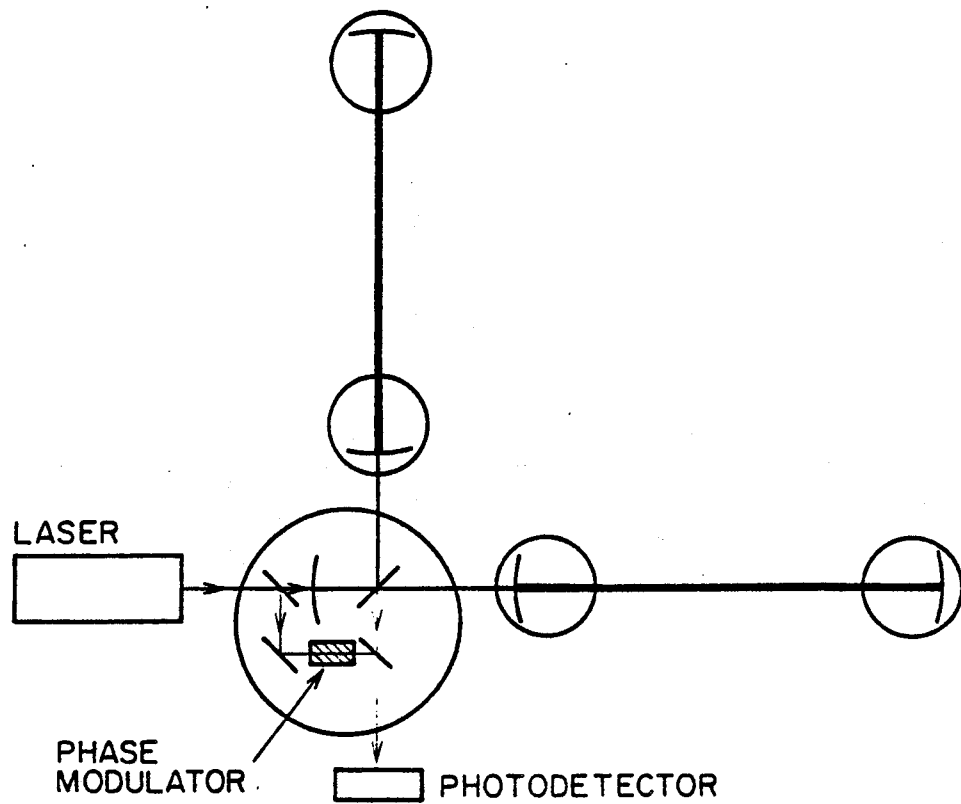

Figure 4.3 More practical version of the recycling scheme from Figure 4.2 in which the Pockels cell modulator is placed outside the cavities to reduce losses.

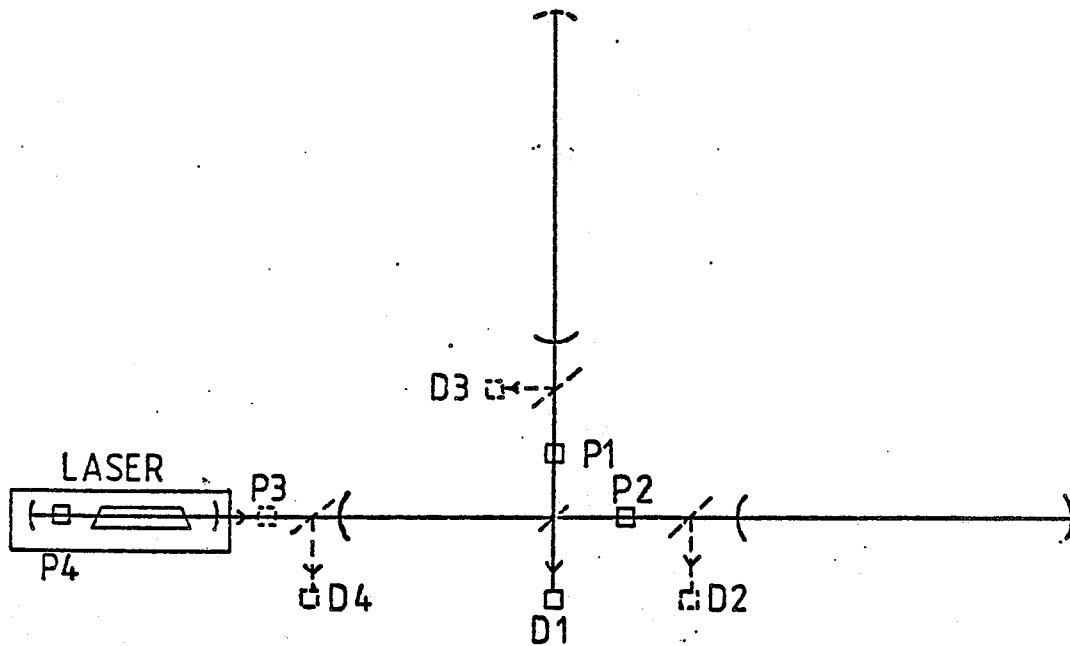

Figure 4.2 Possible method for enhancing the sensitivity of a Fabry-Perot antenna using recycling.

promising for our research. Currently, the low-loss mirrors have only been made in diameters up to 1.5 inches (and these were specially made for the Caltech prototype), but it appears that available equipment could make mirrors up to the 8 inch diameter required for Fabry-Perot cavities or other compact optics (Section 4.5 below) of 5 km length.

4.2. Enhancement of Interferometer Sensitivity for Periodic Signals

A technique for achieving even higher sensitivity in searches for periodic signals has also been conceived in the Caltech work.³ If the light is stored in each arm of the interferometer for a time equal to half of the period of the gravitational wave, and if it is arranged that the light passes from one arm to the other in a suitable way, then the optical phase shifts induced by the gravitational wave may be made to accumulate over many periods, giving a corresponding enhancement in sensitivity. In a delay line Michelson interferometer this might be done as indicated, in principle only, in Figure 4.4. Here light is arranged to circulate round both arms of the interferometer in opposite directions, and a relative phase shift builds up which may be detected as shown. In a Fabry-Perot system, the cavities in the two arms may be coupled together, as indicated in Figure 4.5, so that again a resonant condition is achieved. The operation of this latter system is perhaps more easily understood by considering the whole system as a pair of coupled oscillators, having one resonance which matches the laser frequency, and a second resonance which is made to correspond to the sum or difference of the frequency of the laser and the frequency of the gravitational wave, so that both resonances play a part in enhancing the output signal.

The improvement in sensitivity achievable for a periodic signal by these optically resonant systems is given approximately by the ratio of the total

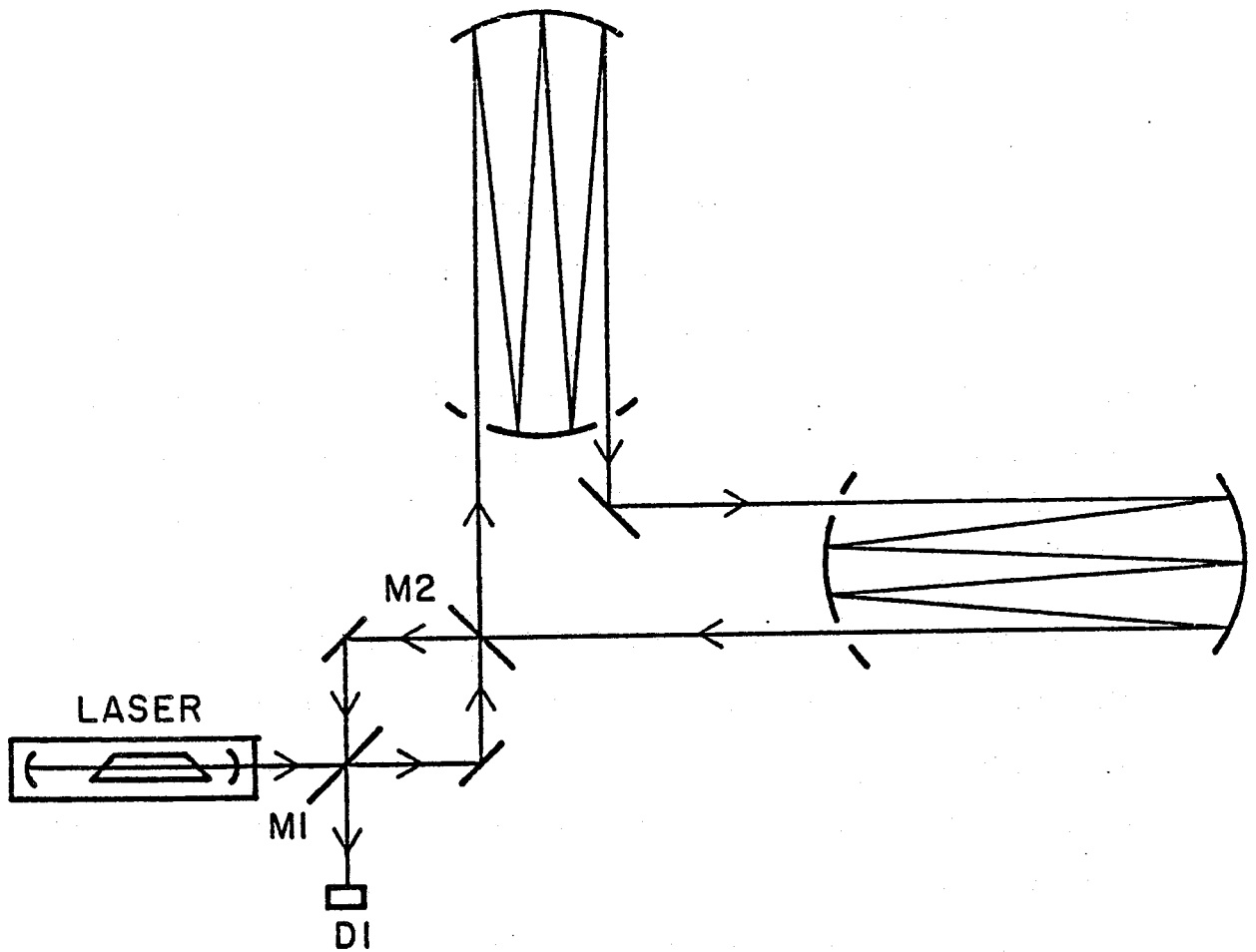

Figure 4.4 Method for enhancing the sensitivity of a delay line antenna for periodic signals.

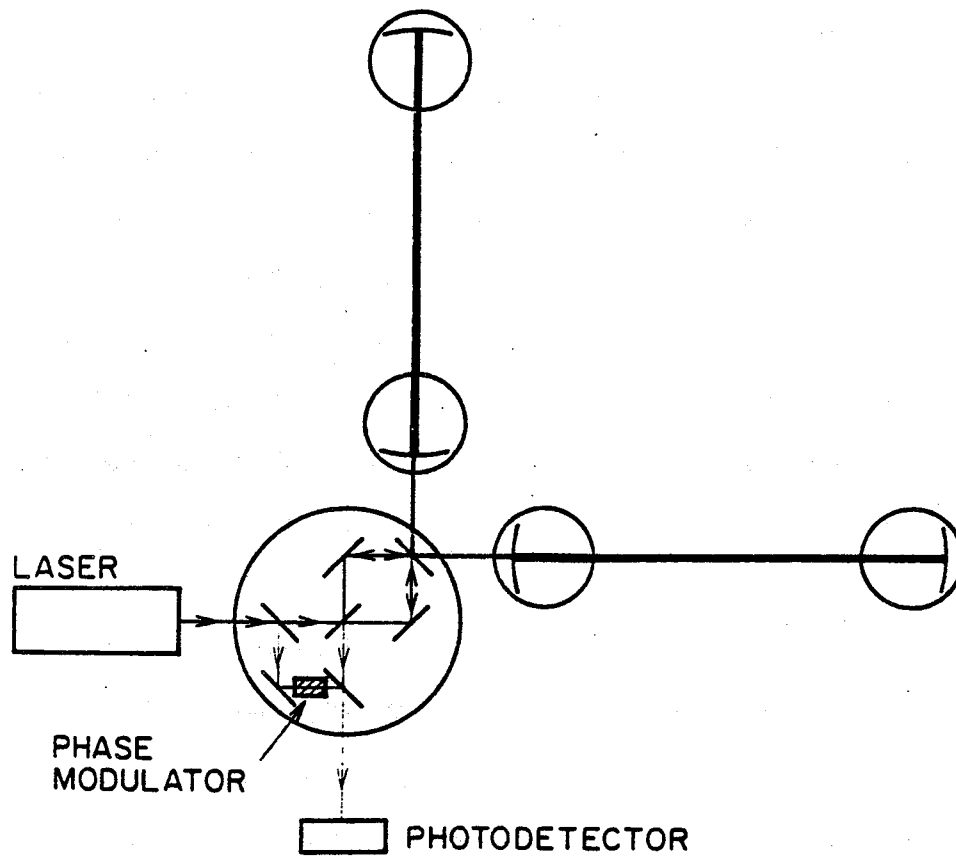

Figure 4.5 Method for enhancing the sensitivity of a Fabry-Perot antenna for periodic signals.

storage time achieved to the period of the gravitational wave, and can be very large in a long baseline detector. For example, the amplitude sensitivity for the signal from a millisecond pulsar might be enhanced by three orders of magnitude, corresponding to a flux sensitivity improvement by six orders, as indicated from the expressions quoted in Section 2.2.2.

The photon shot noise limit to sensitivity for gravitational wave flux in a resonant interferometer of this type varies as the square of the ratio of mirror losses to arm length, so low loss mirrors are even more important here than for pulse searches. This type of search also benefits most rapidly from increase in interferometer baseline, and indeed if stochastic noise forces acting on the test masses can be made small enough to be unimportant then the requirements of periodic gravitational wave searches using resonant interferometers may be among the strongest reasons for building very long baseline systems.

4.3. Seismic Isolation by Differential Monitoring and Coherent Driving of Test Mass Suspension Points

The test masses for our prototype interferometric gravitational wave detectors have been suspended by sets of three or four thin wires, or by thin rods, and for frequencies around 1 kHz these suspensions alone give large attenuation of seismic noise at frequencies away from wire or rod resonances. The addition of relatively simple passive isolation by stacks of alternate layer of rubber and lead within the vacuum tanks - techniques which have been widely used and found satisfactory with resonant bar gravitational wave detectors - can give isolation at these frequencies which is adequate for current experiments at least. At lower frequencies, however, the increasing amplitude of seismic noise together with the decreasing attenuation given by a mass-spring isolator makes simple

passive isolation systems of this type inadequate, and transmission of seismic noise is likely to limit the interferometer performance below a few hundred Hertz. A relatively simple method for improving rejection of seismic noise by the system was proposed at Glasgow in 1976. Here an auxiliary interferometer is set up between the upper points of attachment of the suspension wires, and the output of this interferometer is fed back to a piezoelectric transducer which drives one of the suspension points, so that the difference in distance between the suspension points of the masses in each arm remains constant. Thus the suspension points are forced to move in a highly correlated way, and if the wire lengths and test masses are suitably matched to one another the seismic disturbances should cancel out, at least to first order. Indeed, it can be shown that if the sensitivity of this seismic monitor interferometer is as good as that of the main interferometer, then seismic noise can in principle be made unimportant at all frequencies above a few times the frequency of the pendulum mode resonance of the test masses, typically of order 1 Hz. In practice it would be difficult to achieve isolation as good as this, because of limitations of servo loop gain in a system with many mechanical resonances and also because of high-order couplings of seismic noise from other degrees of freedom. However a useful improvement in low frequency isolation seems relatively easily obtained by this method, and in addition the residual error signal from the monitoring interferometer could be used for some further seismic noise compensation during subsequent data analysis, as well as providing a check for unusually large disturbances penetrating the passive isolation.

For modest improvements in isolation the monitoring interferometer can be a relatively simple one, possibly just a single-pass Michelson using small laser power, and the small beam diameter required could be accommodated fairly easily in vacuum pipes of the diameter we propose.

4.4. Techniques for Active Seismic Isolation of Individual Test Masses

The differential suspension point monitoring and driving technique just described is one method for improving on the performance of a passive suspension. However it only operates in one dimension, and is likely only to be practicable and economical with large-diameter vacuum pipes - which indeed we are proposing to use in this project. A considerable effort has gone into more general types of active seismic isolation in various laboratories. A promising approach for gravitational wave detectors involves causing the suspension point of each test mass to track the motion of the mass below it, using a high-gain servo loop. This method has been extensively experimentally developed at Glasgow, primarily for the horizontal degrees of freedom most relevant for gravitational wave detectors.³⁶ An equivalent system for vertical motions has been very successfully developed at JILA for isolation of gravimeters,³⁷ and a vertical system motivated by 1962 work of Robert Dicke has been tested at MIT. A general analysis of several of these systems has been carried out at MIT. The existence of tilt components in the seismic noise makes horizontal isolation more complicated in these schemes than vertical isolation, because of the difficulty of defining a steady vertical reference against which to monitor the relative positions of test mass and suspension point. A technique using a "reference arm" - a vertical arm of large moment of inertia freely suspended at its center of gravity - was introduced at Glasgow to avoid this problem; and use of the moment of inertia of the test mass itself has also been suggested at MIT.

The improvement in isolation achieved by these techniques is usually limited in practice by the existence of mechanical resonances in the various structures involved; and for this reason multistage isolation systems have been considered at Glasgow, Caltech and MIT for achieving greater isolation.

Coupling between successive isolation stages may cause difficulties in such systems, and methods of compensating reaction effects have been devised at Glasgow and Caltech, and coupling effects in uncompensated systems have been analyzed at MIT. Overall, it looks likely that extremely good seismic isolation can be achieved by active isolation methods, although the systems may become relatively complicated for large degrees of low frequency isolation.

It should be noted that passive isolation seems entirely adequate for gravitational wave experiments at frequencies down to a few hundred Hertz, and we may use this alone for the first experiments in the large installations. The development of complex active seismic isolation techniques is likely to be more important for subsequent extension of the experiments to much lower frequencies, and the vacuum tanks we propose will be designed with such extension in mind.

4.5. An Alternative Interferometer System

The basic multireflection interferometer systems tested to date have been of two types - the delay line Michelson interferometer and the Fabry-Perot cavity interferometer. Other types are possible, however, and it is interesting to note that a third type of multireflection interferometer, the frequency-tagged interferometer, was recently devised independently and at about the same time at both Caltech and MIT. In this system, the light in each arm of a basic Michelson interferometer bounces back and forth in each arm of the gravitational wave detector between a distant mirror which is similar to that used for a Fabry-Perot cavity, and an inboard reflecting system on one of the central masses which is itself made up from a frequency-selective system such as a smaller Fabry-Perot cavity. The light within the arm is made to shift in frequency on each pass through the system, so that after entering at a frequency

corresponding to one mode of the input Fabry-Perot it becomes trapped until it has made enough passes for its frequency to match another mode of the input cavity, at which time it escapes. Thus a system giving a discrete number of reflections is achieved with mirrors of small diameter. The frequency shifting could be obtained in several different ways: Doppler shifting by moving one of the mirrors has been suggested at Caltech, and use of electro-optic or acousto-optic devices within the arms has been suggested at MIT.

At present it is not clear if this type of interferometer has significant advantages over systems already being developed, but we mention it partly to indicate that new ideas continue to arise in this field; and we feel it is important that our proposed vacuum facilities are made sufficiently flexible to accommodate a wide range of optical systems.

4.6. Discrimination Against Local Disturbances By Use of Half- and Full-length Interferometers.

This section and the next deal with ideas that influence the experimental strategy.

Experience with resonant bar gravitational wave detectors as well as with prototype laser interferometer detectors has shown that such instruments usually give significant numbers of spurious output pulses which form a serious background for gravity wave pulse searches. These may come from many sources, including release of strain in the test masses, mode hops in the laser, outbursts of gas from the walls of the vacuum pipes, seismic disturbances, and rapidly changing gravitational gradients due to moving local objects. Monitors for some of these phenomena may be used to reject many of the spurious pulses; but the most powerful single method of discrimination against such

effects will come from the cross correlation of data from the two widely separated sites. This cross correlation may well involve a real-time, wide-bandwidth data link. This method alone, however, can only be effective in the search for rare signals if the rate of individual spurious pulses from each site is low; and it may be difficult to achieve this with single interferometers. The situation may be improved significantly by use of a pair of interferometers at each site, arranged to give signals related to one another in a known way. An economical solution is possible if the interferometers use optics sufficiently compact to allow two or more separate interferometer beams to be accommodated alongside one another within the same vacuum system. If one interferometer is made to span half the length of each arm of the vacuum system, then a comparison of signals from this half-length interferometer and from the full-length one can discriminate against many, but not all, types of spurious phenomena. In particular, bursts of gas from the vacuum pipe walls would give strain signals of quite different sizes in the two interferometers, as would changes in gravitational gradients from local moving objects; and pulses due to mode hops or other transient optical effects would be unlikely to be coincident if separate lasers were used. Thus, these types of phenomena could be rejected efficiently, at least for signals large compared with system noise. Important additional data would be available on candidate gravitational wave events, for the signature of a gravitational wave burst would have to include matching waveforms from the full- and half-length interferometers at each site, with their displacement amplitudes in the ratio of 2:1, and in general it would be unlikely for disturbances to mimic this.

Half-length interferometers, together with full-length ones, could be useful in other ways. In particular, they would speed up investigations of noise sources and facilitate the general debugging of the apparatus by providing some

discrimination between various spurious phenomena, and they would permit development to proceed efficiently even in the absence of a real-time data link between the sites, or at times when one site might be out of action due to equipment failure or rebuilding.

4.7. Operation of Multiple Interferometers Within a Single Vacuum System

A rudimentary long baseline system would consist of a pair of facilities separated by a large distance, each including just one receiver system. This is certainly a valid concept, and an optimization of our limited resources might lead us to use it for our initial experiments. However, there are other possible experimental arrangements involving two or more interferometer systems in a single beam pipe at each site, which would give greater flexibility, scientific productivity, and overall performance -- though at a price of requiring greater resources for the receivers and the antenna facilities. The half- and full-length interferometer system described in the last section is a special case of this more general concept of multiple use of a single vacuum system, which has gradually developed at Caltech and Glasgow.

The cost of vacuum pipes in the size ranges we are considering does not vary very rapidly with pipe diameter, and pipes of the diameter which we wish to use for experiments with delay line Michelson interferometers would in principle be able to contain up to 20 separate interferometers using Fabry-Perot or other compact optical systems. This opens interesting new possibilities. It could obviously provide useful redundancy in simple experiments; but, more importantly, it can make practical highly efficient simultaneous searches for several different types of gravitational wave signal. The optimum design of test mass for an interferometric detector depends on the time scale of the signals being sought, for at low frequencies thermal noise comes mostly from the pendulum mode of the

suspension and is reduced by use of a large mass; while at higher frequencies thermal noise from internal modes tends to be dominant, and may be reduced by use of small masses, giving high frequencies for internal resonances and possibilities of fabrication from low-loss material such as monocrystal sapphire. Thus higher effective sensitivity may be obtained by operating simultaneously with a number of relatively specialized test masses instead of with a single one whose design is more of a compromise. Further, the new interferometer techniques outlined above in (4-1) and (4-2) give possibilities of large improvements in sensitivity for both wideband and periodic signals, with the maximum improvements achieved by matching the optical system to the signal being sought. Again, greatly improved overall performance may be obtained by use of a number of different types of receiver elements instead of any single one. A schematic diagram of a possible arrangement is shown in Figure 4.6.

A multiple interferometer system has other useful benefits over the long run. As a number of parallel experiments become economically practicable there are more opportunities for interesting individual experiments by scientists and graduate students. This is particularly important in a project involving a modestly large investment such as the one being proposed here, and it is likely to lead to much more stimulating and effective research.

4.8. Note on Overall System Outlined Here

Putting together the various experimental techniques and ideas outlined above along with the encouraging results with ultra-low-loss mirrors described in section 3.2 leads to a concept for a complete interferometric gravitational wave detection system with very attractive features: high sensitivity (bottom curves of Figures 2, 3, and 4), great flexibility, good discrimination against spurious phenomena, and potential for high scientific productivity. This concept for a

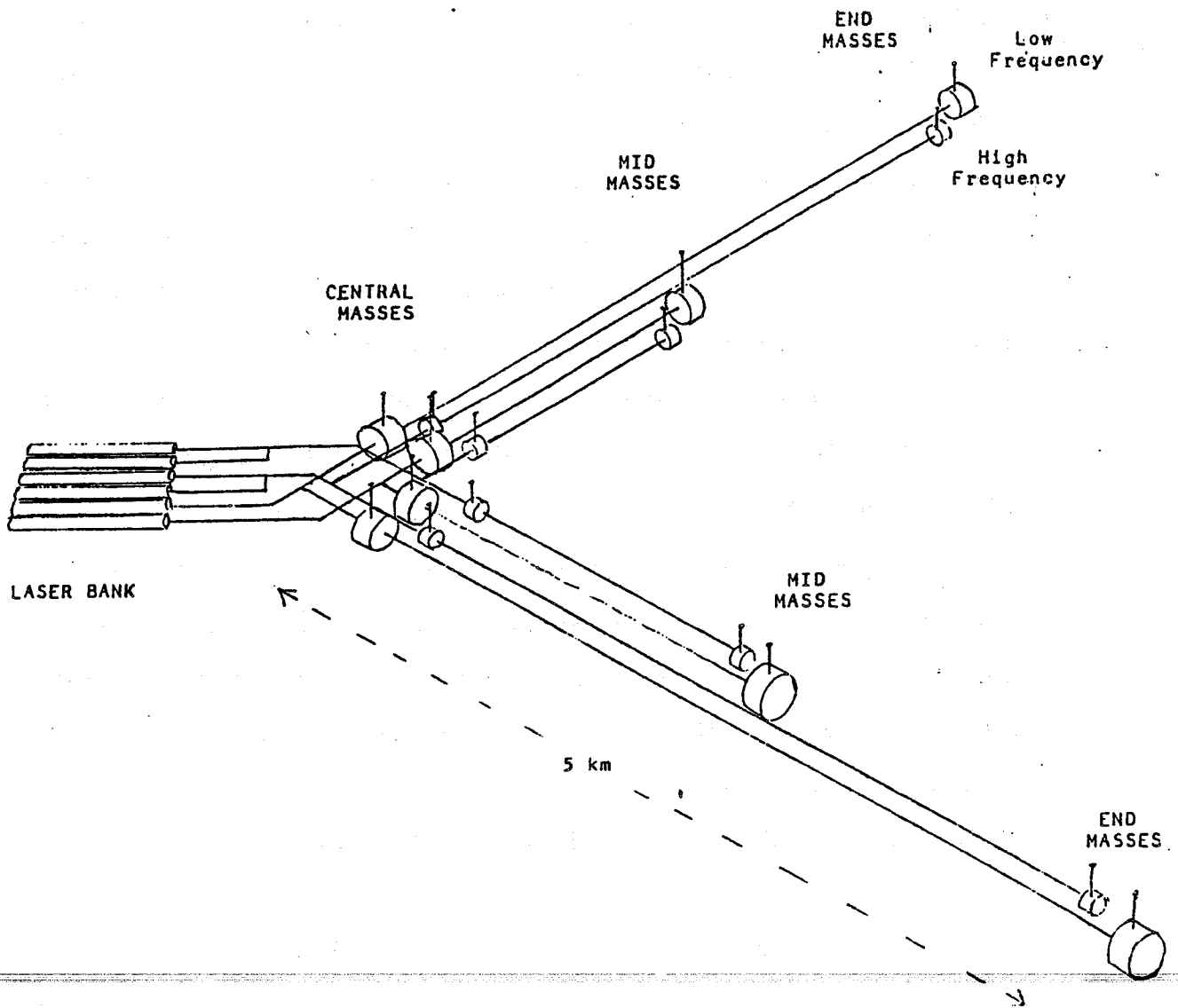

Figure 4.6 Example of a possible type of multiple interferometer system. Initially only some of the masses might be installed. Further masses—and possibly more than those shown here, to facilitate periodic searches—might be added later. (Note diagram is highly schematic and not to scale: light beams would be closely packed to fit within the single vacuum pipe for each arm.)

complete gravitational wave detection system is an attractive long range goal for our proposed facilities. Experimental work to verify some of the ideas not yet tested is planned for the near future.

5. ARGUMENTS FOR LARGE-SCALE INTERFEROMETER SYSTEMS

The preceding description of the state of prototype detectors and recent ideas for achieving extremely high performance in large detectors has shown the near maturity of interferometer technology. Four of the groups working in the field have achieved shot noise limited displacement sensitivity, albeit at relatively modest light powers. The 40 meter interferometer at Caltech and the 30 meter interferometer at Munich have both achieved gravitational wave sensitivities matching those reached in the room temperature bar detector used in previous coincidence gravitational wave searches, but with bandwidths enormously greater than reached with the most sensitive of those detectors. Further, the Caltech instrument has recently achieved a light storage time in its Fabry-Perot cavities more than sufficient for optimum sensitivity in gravity wave experiments at frequencies from 500 Hz upwards; and it has also demonstrated essentially continuous operation for a period of 10 days in a search for pulsar gravitational radiation.

Still, several problems remain. Although technical development is proceeding rapidly, sensitivities which are astrophysically interesting ($h_{\text{rms}} \sim 10^{-21}$ or better) will be very difficult to achieve in the prototype-scale systems, because of noise sources other than photon shot noise. This is because all the other important noise sources of which we are aware diminish in size as the length of the interferometer arms grows, for a given fixed light storage time. The most fundamental "noise" comes from the quantum limit to the accuracy of sensing motions of the test masses, corresponding to the Uncertainty Principle, and this scales as l^{-1} , where l is the length of the interferometer arms. Noise due to fluctuations in the index of refraction of the residual gas in the vacuum system scales as $l^{-3/4}$. The noise which is due to stochastic forces acting on the end masses scales as l^{-1} . This strong reduction in stochastic noise sources with

increased length is the fundamental justification for making an interferometric system large.

The most important stochastic forces are the coupling of seismic and acoustic vibrations to the end masses, and thermal excitation of the normal modes of the end masses and of their suspensions. Seismic and acoustic noise are strongest at low frequencies not only because the seismic noise amplitude spectrum has a frequency dependence of f^{-2} , but because suspension designs which isolate the test masses can be made to work better at high frequencies than at low ones. Thermal excitation of the normal modes of the suspensions gives a strong noise peak at the fundamental (~ 0.5 Hz) and much weaker peaks at higher frequencies (typically ~ 700 Hz and multiples of this). In addition the thermal vibration of the end masses themselves has a white spectrum below the first resonance (typically in the range 5 kHz to 25 kHz). To some extent, by making the test masses smaller and their suspensions stiffer, it is possible to trade poorer sensitivity at low frequencies for improved sensitivity at high frequencies.

The true promise of interferometric antennas lies in the possibility of achieving the even higher sensitivities likely to be required for detection of expected signals (r.m.s. noise levels of about 10^{-22} for millisecond pulses, and 10^{-26} or better for periodic signals); and also in their ability to work at frequencies as low as 100 Hz, or even (with a major effort in suspension design or using the technique of Section 4.3 and 4.4) as low as 10 Hz. In the low frequency region possible signals from a number of fast pulsars, including the Crab and Vela pulsar, may become visible. Most importantly, the signals from the decay of the orbit of a pair of condensed objects, such as the binary pulsar, become easier to detect in this band shortly before the final collision because of the longer integration time allowed here than in the kilohertz band.

In a given instrument, the largest noise source present defines the limiting sensitivity. The techniques of light recycling and resonant interferometers give promise of reducing photon shot noise significantly in long baseline instruments, the residual photon noise scaling as $l^{-1/2}$ and l^{-1} respectively. To make thermal noise as low as this potential photon shot noise is much easier with long arms than with short. For all these reasons, it seems likely that the maximum probability of achieving the goal of detection of gravitational radiation will be obtained by construction of large baseline, gravitational wave detectors. This is what we are proposing to do.

II. THE PROPOSED FEASIBILITY AND DESIGN STUDIES

6. PAST AND PRESENT COST AND FEASIBILITY STUDIES FOR THE MAJOR FACILITIES OF A LARGE-SCALE INTERFEROMETER SYSTEM

6.1. Introduction

In previous sections we have described several features which would be desirable in a vacuum system for full scale laser interferometer gravity wave antennas. Among these are:

- (i). as great an arm length as possible;
- (ii). vacuum pipe diameter and end stations sufficiently large to accommodate all types of antennas that one might wish to construct, and to accommodate several antennas of the more compact varieties simultaneously;
- (iii). vacuum as good as possible (10^{-8} torr or better for the most sensitive present antenna designs).

Of course, the vacuum system that we actually build must be constrained by real-world considerations of cost and of construction feasibility. To determine these constraints and give us a firm basis for the choice of a final design, we have carried out two feasibility and cost studies of long baseline vacuum systems. This section describes those studies and the following section describes ~~the procedure that we will use, based on those studies, to arrive at a final~~ design.

The first study that we will describe was carried out by industrial firms (A.D. Little, and Stone & Webster) under the guidance of the MIT group; so we shall refer to it as the MIT study. Its goal was to establish feasibility, and cost scaling laws. No specific optical configuration or experimental strategy was assumed in the course of the study. The study was intended to be a resource for follow-on

design decisions and trade-off studies. The results of this study were used by the Caltech/MIT groups to set the initial cost estimate for the overall project at NSF presentations in the fall and winter of 1983-84.

The second study that we will describe is now being carried out by a team of JPL engineers under the sponsorship and direction of the Caltech group and in consultation with the MIT group, so we shall refer to it as the JPL study. It builds on the results of the MIT study but is more ambitious in scope. It is primarily intended to assess the costs and impact on the vacuum facilities of various experimental strategies extending from a facility able to support a single receiver element of modest sensitivity to a strategy incorporating multiple receiver elements and receivers of much higher sensitivity and thus better vacuum than assumed in the MIT study. The JPL study also includes a reanalysis and updating of the cost estimates of the MIT study and an in-depth survey of the candidate sites for the vacuum systems.

The results of the two studies will be used by the Caltech and MIT research groups in a trade-off analysis before fixing the final design and specifications for the vacuum system (see next section). A guiding principle in this trade-off analysis will be, within the constraints of the established project cost, to make the facilities sufficiently flexible in design to permit upgrading to accommodate receivers of increasing sensitivity as the receiver technology improves. ~~Although we cannot anticipate all the requirements for the approximately 20~~ year lifetime of the facilities, it is clear that improvements in receiver sensitivity will place severe demands on the vacuum levels and ultimately on the diameter of the vacuum tubing.

6.2. The MIT Study

The MIT study,³⁴ carried out in conjunction with A.D. Little and Stone & Webster, focused on the vacuum system, construction strategies, and the siting of two large baseline gravitational antennas. The study did not focus on one design but rather established cost scaling laws and engineering factors as a function of antenna length and vacuum tube diameter, the relevant parameters needed in follow on trade off studies. Several generic construction strategies were studied, again with the intent of offering options for follow-on trade-off studies.

The MIT study resulted in a thick report which is available upon request.³⁸ We here describe briefly the study and its main conclusions.

6.2.1. The A.D. Little Study of the Vacuum System

The input specifications were to study the design and costs of a vacuum system able to maintain 10^{-6} torr which could be upgraded to 10^{-8} torr (cost of upgrade not estimated) as a function of tubing diameter and vacuum system length. A second task was the design and costs of instrumentation station vacuum enclosures with pressures of 10^{-6} torr and upgrade to 10^{-8} torr. Costs of this upgrade were included in the study. To scale the rough pump system, a pump down time of several days was specified. The valving strategy specified required the ability to isolate high-vacuum pumps and to isolate the long tubing from the instrumentation stations.

Mild steel, stainless steel, and aluminum tubing were considered in the study. Aluminum was chosen as the most cost-effective material. Aluminum has similarly good high-vacuum characteristics as stainless steel and can now be welded reliably and automatically. The penalties are aluminum to stainless steel transition sections which will be required between the instrument stations and the long tubing and between the expansion bellows. Aluminum bellows are now

coming on the market and it is conceivable that these would be used in the system.

The high-vacuum pumps chosen were getter ion pumps because of their minimal maintenance requirements, reliability, and freedom from inducing mechanical vibration. The roughing pumps were designed to start ion pumps and therefore able to reach 10^{-4} torr.

Instrumentation vacuum chambers, of cylindrical geometry with 14 ft diameter and height, were designed and costed. The chambers, constructed of stainless steel, were designed to be outgassed and able to reach 10^{-8} torr.

A technique to align the tubes was studied; the concept uses Fraunhofer diffraction masks in a scheme similar to that used at SLAC.

Figures 6.1 and 6.2 show the summary costs of the A.D. Little study. These figures include the costs of an on-site facility for cleaning the tubing prior to welding.

6.2.2. The Stone & Webster Study of Sites

Surface as well as mine sites were considered. The criteria for the selection of sites included the following: flat topography, accessibility to labor, transport, power and water, minimization of anthropogenic noise sources both transmitted by the ground and the air, and the probability of large-scale seismicity. The study focused on government held lands and in particular developed sites such as national laboratories and military bases to increase the probability of gaining access to the site as well as to benefit from previously installed electrical power and buildings.

The results of the siting study are shown in Table 6.1 and Figure 6.3. Although mine sites are shown on the figure, no mine was found that could accommodate an L with 5 km legs without additional tunneling. The tunneling

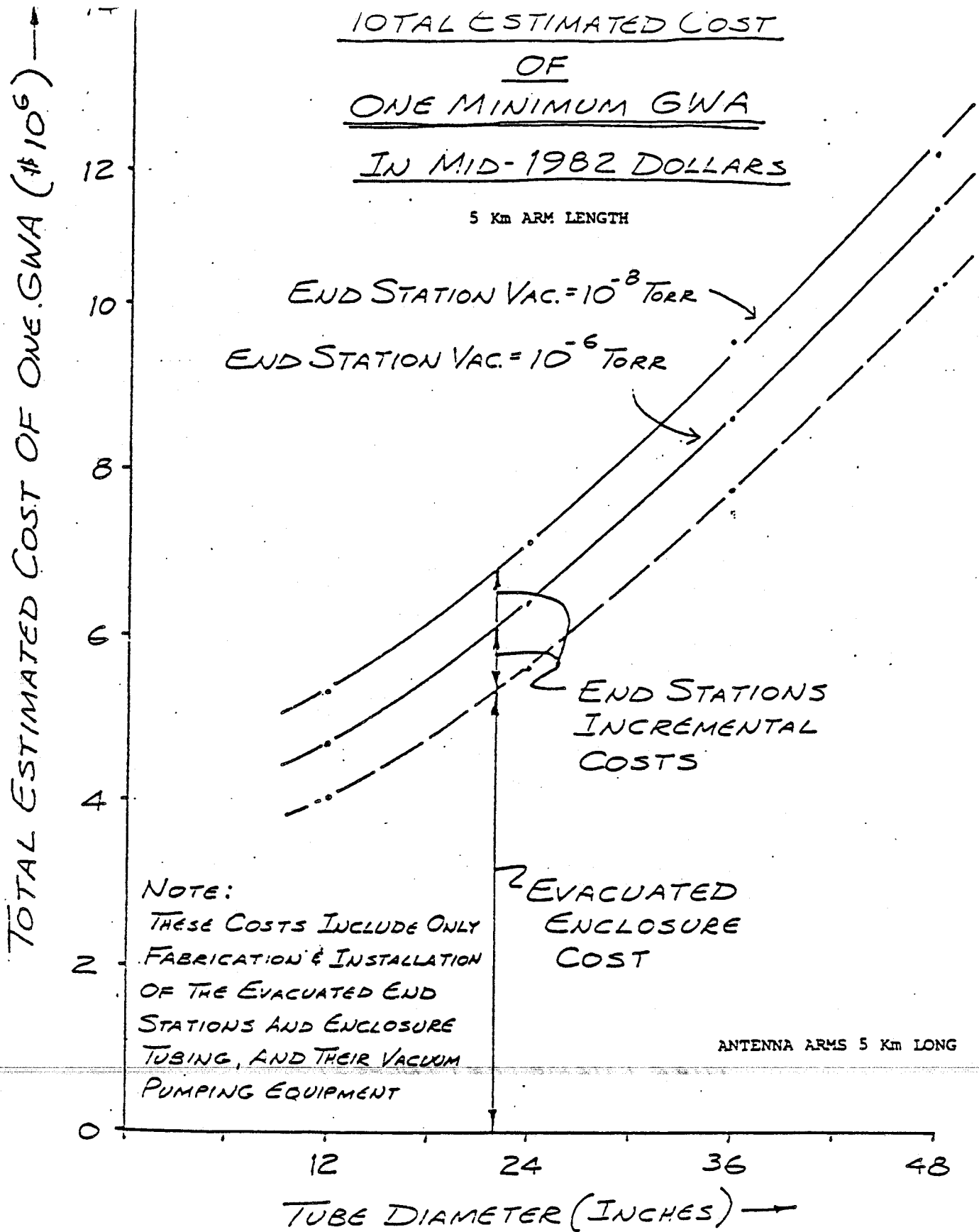
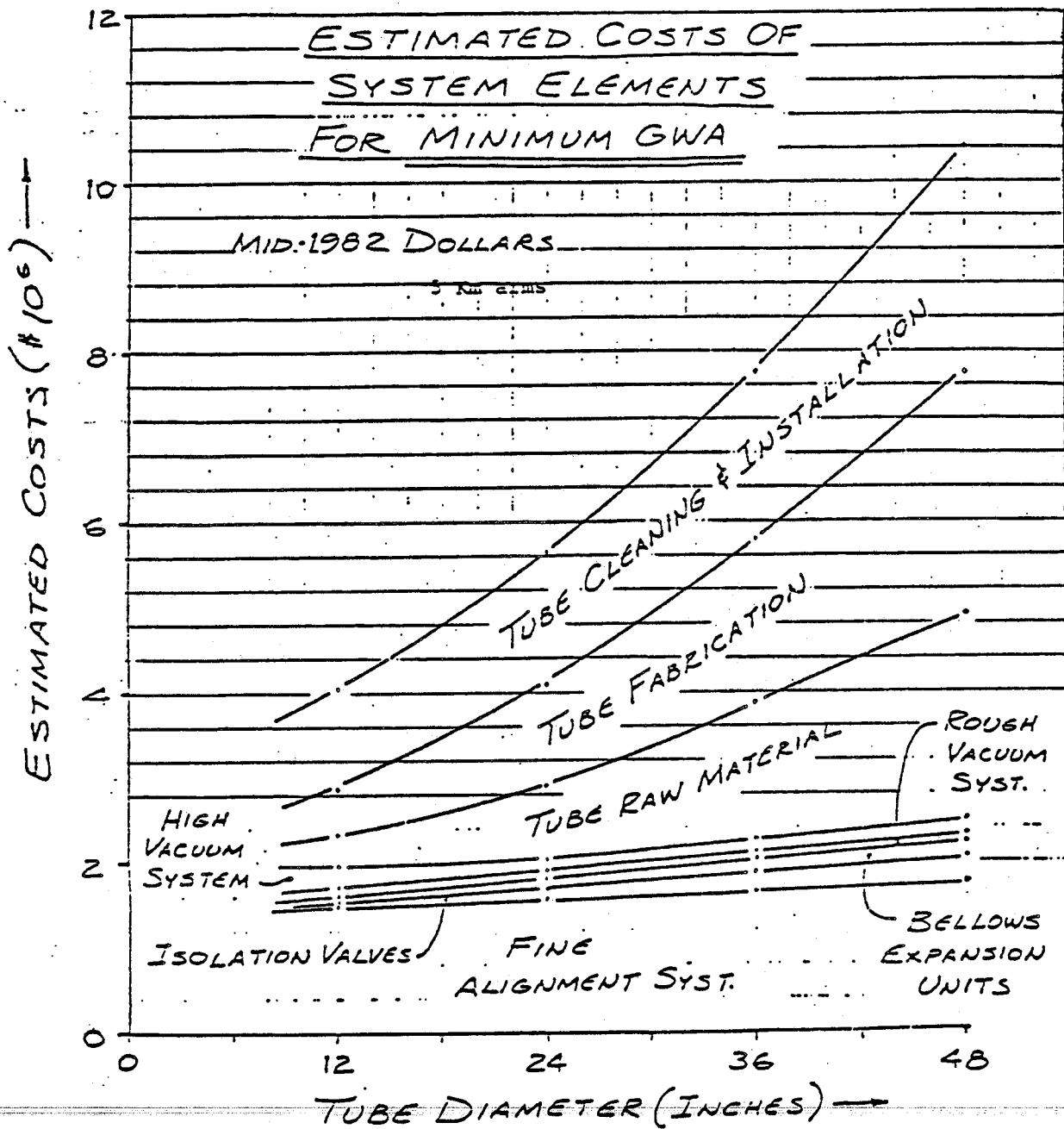

Figure 6.1



5km Antenna Arms

Figure 6.2

Table 6.1 Candidate Sites

Luke Air Force Range, Arizona

San Cristobal Valley, Arizona

Bristol Lake, California

Edwards Air Force Base, California

Goldstone, California

Alamosa Area, Colorado

Eglin Air Force Base, Florida

Fort Stewart, Georgia

Idaho National Engineering Laboratory, Idaho

Cherryfield, Maine

Saponac, Maine

Easton, Massachusetts

Fort Bliss, New Mexico

Plains of San Augustin, New Mexico

White Sands Missile Range, New Mexico

Great Salt Lake Desert, Utah

Lynndyl, Utah

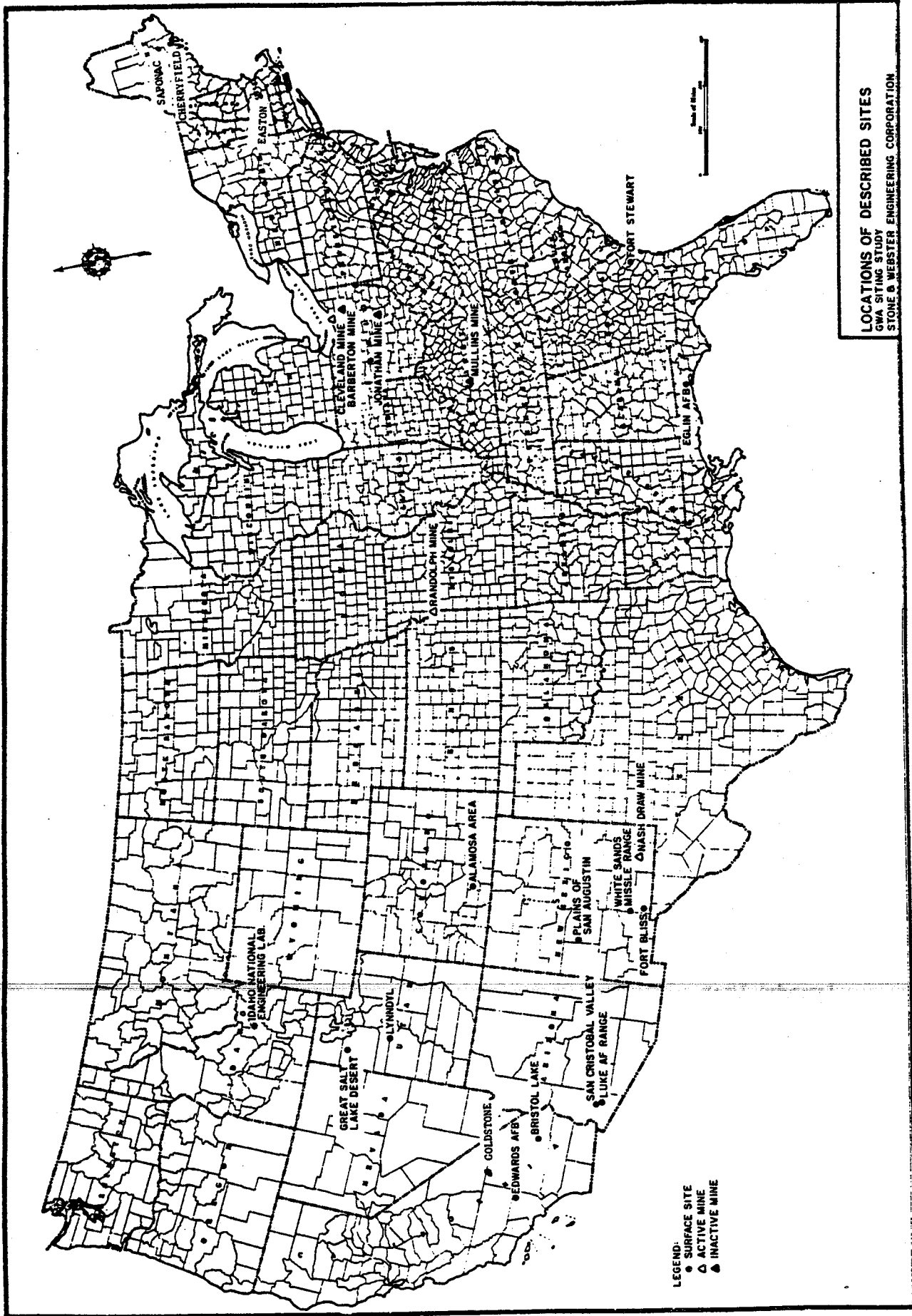

Figure 6.3 Locations of potential sites considered in Stone and Webster and subsequent studies.

costs are extremely variable depending on the material mined, the ability to sell the mined material and the availability of machinery in the mines. The time for excavation is another uncertain parameter. Mine sites have been eliminated from further consideration.

6.2.3. The Stone & Webster Study of Construction Strategies

Several concepts for the construction were studied as a function of tube diameter and length. Generic construction costs were made as no particular sites were specified. Length independent costs include: buildings, power transmission and distribution, cooling systems for the lasers, and estimates for the receiver costs. It was assumed that some shop and staging facilities would be required on the site.

Three construction options were considered for a surface installation:

1. Option 1: The vacuum tubing is installed on piles above the surface with varying amounts of insulation on the tubing. A constraint of less than 1 cm of motion was specified for the tube due to maximal wind loading.
2. Option 2: The vacuum tubing is installed as in Option 1 but not exposed to the elements. A corrugated steel cover surrounds the vacuum tube and the entire structure lies under an earth berm.
3. Option 3: The system is buried in an open trench construction. The tubing is supported on piles within a corrugated steel cover. The cover itself is a clamshell; half of the cover is installed to retain the trench while the tubing is installed, aligned, and welded. After completion of the alignment the other half of the cover is installed and the trench is refilled with dirt. The cover is sufficiently large to allow access for subsequent realignments and leak hunting. Figure 6.4 shows schematics of the three options and Table 6.2 shows the costs as a function of tube diameter for the various options.

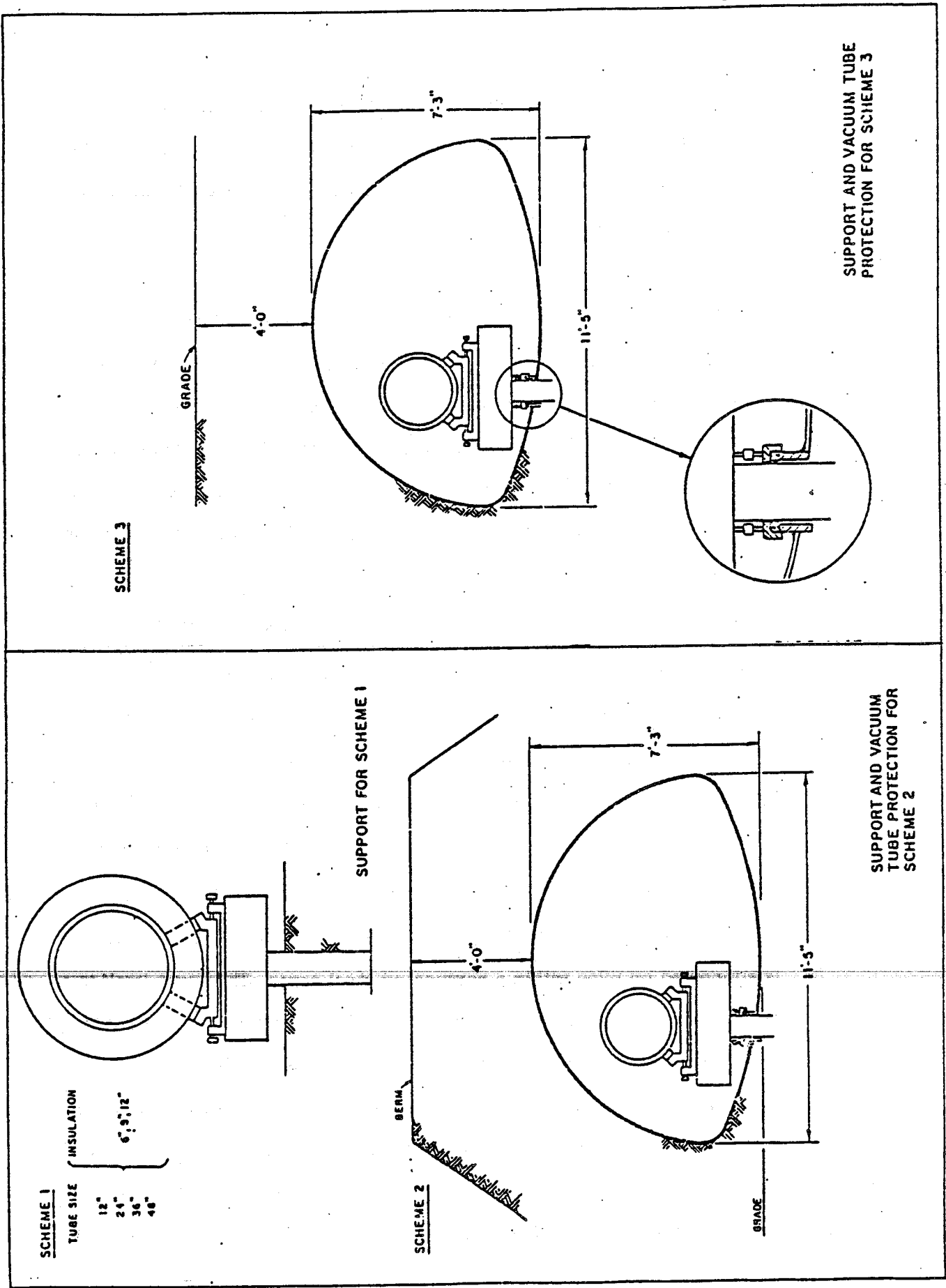

Figure 6.4 Construction methods costed in Stone and Webster study.

Scheme No.	Support Buildings	End Stations	Cooling System	Ventilation	Transmission Line - 8 Miles & Line To Tunnel	Power Distrib.	Line Tie-In	Wiring To Vaults	Total Fixed Cost
1.	112	807	250	---	680	1,831	950	250	4,880
2.	112	807	250	---	680	1,831	950	250	4,880
3.	112	864	250	---	680	1,831	950	250	4,917
								Use	4,940
4.	112	1,560	350	260	1,330	1,831	950	220	6,613
								Use	6,610

FIXED COST INDEPENDENT OF LENGTH (10³ \$)

TABLE 62

Scheme No. & Tube Size	Clearing & Grading	Trenching, Bedding & Backfill	Tunneling 10'x12'	Ventil. Tunnel	Supports	Insulation (Based on 6")	Tube Housing	Berm	Electrical	Total Per Km
1										
12"	10	---	---	---	122	111	---	---	100	343
24"	10	---	---	---	104	198	---	---	100	412
36"	10	---	---	---	156	334	---	---	100	600
48"	10	---	---	---	259	485	---	---	100	854
2										
12"	14	---	---	---	76	---	689	151	100	1,030
24"	14	---	---	---	78	---	689	151	100	1,032
36"	14	---	---	---	56	---	689	151	100	1,010
48"	14	---	---	---	66	---	689	151	100	1,020
3										
12"	28	249	---	---	76	---	689	---	100	1,142
24"	28	249	---	---	78	---	689	---	100	1,144
36"	28	249	---	---	56	---	689	---	100	1,122
48"	28	249	---	---	66	---	689	---	100	1,132
4 (Nine)										
12"	---	---	656	46	74	---	---	---	88	864
24"	---	---	656	46	84	---	---	---	88	874
36"	---	---	656	46	63	---	---	---	88	853
48"	---	---	656	46	70	---	---	---	88	868
12"	---	---	902	46	74	---	---	---	88	1,110
24"	---	---	902	46	84	---	---	---	88	1,120
36"	---	---	902	46	63	---	---	---	88	1,099
48"	---	---	902	46	70	---	---	---	88	1,114

COSTS DEPENDENT ON LENGTH (10³ \$/km)
 TABLE 6.2 (cont'd.)

Scheme No.	Tube Size	Fixed \$	Total Variable Costs K\$	Total M\$
1	12"	\$4,880	\$3,430	8.3
	24"	4,880	4,120	9.0
	36"	4,880	6,000	10.9
	48"	4,880	8,540	13.4
2	12"	4,380	10,300	15.2
	24"	4,880	10,320	15.2
	36"	4,880	10,100	15.0
	48"	4,880	10,200	15.1
3	12"	4,940	11,420	16.4
	24"	4,940	11,440	16.4
	36"	4,940	11,220	16.2
	48"	4,940	11,320	16.3
4 (Mine)	12" 8 KM of Tunneling	6,610	(6,912)	(13.5)
			(8,880)	(15.5)
			(6,992)	(13.6)
			(8,960)	(15.6)
	24" 10 KM of Tunneling	6,610	(6,824)	(13.4)
			(8,792)	(15.4)
			(6,944)	(13.6)
			(8,912)	(15.5)
36" 10 KM of Tunneling	6,610	(8,640)	(15.2)	
		(11,100)	(17.7)	
		(8,740)	(15.3)	
		(11,200)	(17.8)	
48" 10 KM of Tunneling	6,610	(8,530)	(15.1)	
		(10,990)	(17.6)	
		(8,680)	(15.3)	
		(11,140)	(17.7)	

TOTAL COSTS - ARM LENGTH - 5km

() = Range Low
High

TABLE 6.2 (cont'd.)

Low Range = \$200* per Linear Foot
High Range = \$275* per Linear Foot

* See Section 9, Page 42.

The table includes entries for mine construction with a range of costs depending on the optimistic to pessimistic assumptions concerning the excavation costs.

6.2.4. The Preliminary Benchmark Design

In the initial trade-off study, Option 3 was chosen. It appeared to have minimum risk but with the substantial additional costs for a cover. The trenching and refilling costs are insignificant. The arguments for Option 3 are thermal stability, no wind loading, reduced environmental impact, reduced corrosion and weathering, safety from animals and intentional and unintentional damage from people. Having chosen this option a decision on tube diameter and arm length followed. Five km was chosen as the longest economically viable, although scientific considerations would argue for longer lengths. The tube diameter was chosen to be 48 inches, the largest compatible with commercially available vacuum equipment. The decision to use 48-inch diameter tubing was based on several factors:

1. Once having chosen Option 3 the incremental costs of going from the minimum tubing size allowed by diffraction (30 inches diameter) to 48 inches was a 10 to 15 percent increase in the overall cost.
2. The largest tube diameter gave the most flexibility for multiple use of the vacuum installation.
3. It gives more leadway in the alignment, and
4. It does not constrain the wave-length of the laser. (One wants to retain the option of using lasers in the 1 to 2 micron region that are more efficient and more powerful than the presently used argon-ion laser at 0.5 microns.)

This preliminary benchmark design carried a price tag of 56 million dollars for the major facilities and the first two antennas - with almost all of the cost

going for the facilities. This design and cost were the basis for joint Caltech/MIT presentations to the NSF Physics Advisory Committee, the National Science Foundation, and the Wilkinson Panel of the NAS Physics Survey Committee in the fall and winter.

6.3. The JPL Study - An Ongoing Study for the Project

6.3.1. Motivation for the JPL Study

The MIT study established the overall costs of many of the elements of a long baseline antenna, but it did not fix a design. Furthermore, as the conceptualization of various possible antenna systems grew more mature it became evident that some of the requirements they would impose on a facility had not been adequately addressed in the MIT study.

More specifically, in addition to the simple concept of installing one receiver at a time in the facilities, new concepts have been evolved at Caltech which envision multiple simultaneous use of the facilities (Section 4.6). Also, the possibility of using cavity mirrors of relatively small diameter (17 cm for a 5 km system) makes it quite realistic to plan use of mirrors having very low losses from the beginning, making recycling and optical resonating techniques (Sections 4.1 and 4.2) practical from very early in the project - probably even in some of the first experiments - and making very high sensitivity an early target. The use of vacuum pipes of relatively large diameter, to accommodate the requirements of delay line techniques, and the small size of the Fabry-Perot mirrors makes it possible then to accommodate the cavity beams of several different interferometers simultaneously - one could envisage from 6 to 12. This permits observations of motions of test masses placed half way along the arms of the vacuum system as well as at the ends to reject local disturbances (Section

4.5) and simultaneous searches with test masses optimized for different types of signals (Section 4.6). With the use of very low loss mirrors a vacuum of about 10^{-8} torr is necessary to prevent fluctuations in the refractive index from compromising the potentially high sensitivity.

In vacuum pipes of 48 inches diameter, it would be possible in principle to operate 20 or more compact interferometers simultaneously, although this would require complex and inconvenient design of test masses to avoid obstruction of some of the beams. One would consider much more modest multiplexing of the vacuum system in the early phases of the program. A possibility is to design the vacuum tanks to accommodate only three sets of test masses in the initial phase of operation of the system. A scheme of arranging this is indicated schematically in Figure 6.5, where a vacuum tank configuration intended to minimize interference between the separate experiments is suggested. One would not necessarily plan to mount all three interferometers right at the beginning, but it may be important to have the possibility of putting them into operation very rapidly.

In a second phase one might plan to increase the practicable number of experiments, by adding further vacuum tanks to the system, possibly to accommodate six sets of test masses. To increase further the number of parallel experiments would probably require some readjustment of optical beam positions, and this might be left for a third, later phase.

These concepts for possible antenna systems are more complex and aim for higher sensitivities than the concepts that underlay the MIT study; and, as a result, they require features in the vacuum system that were not costed in the MIT study. The task of costing these features, the task of reanalyzing and updating the cost estimates of the MIT study, and the task of studying potential sites in greater detail have been undertaken by a team of engineers at JPL, with

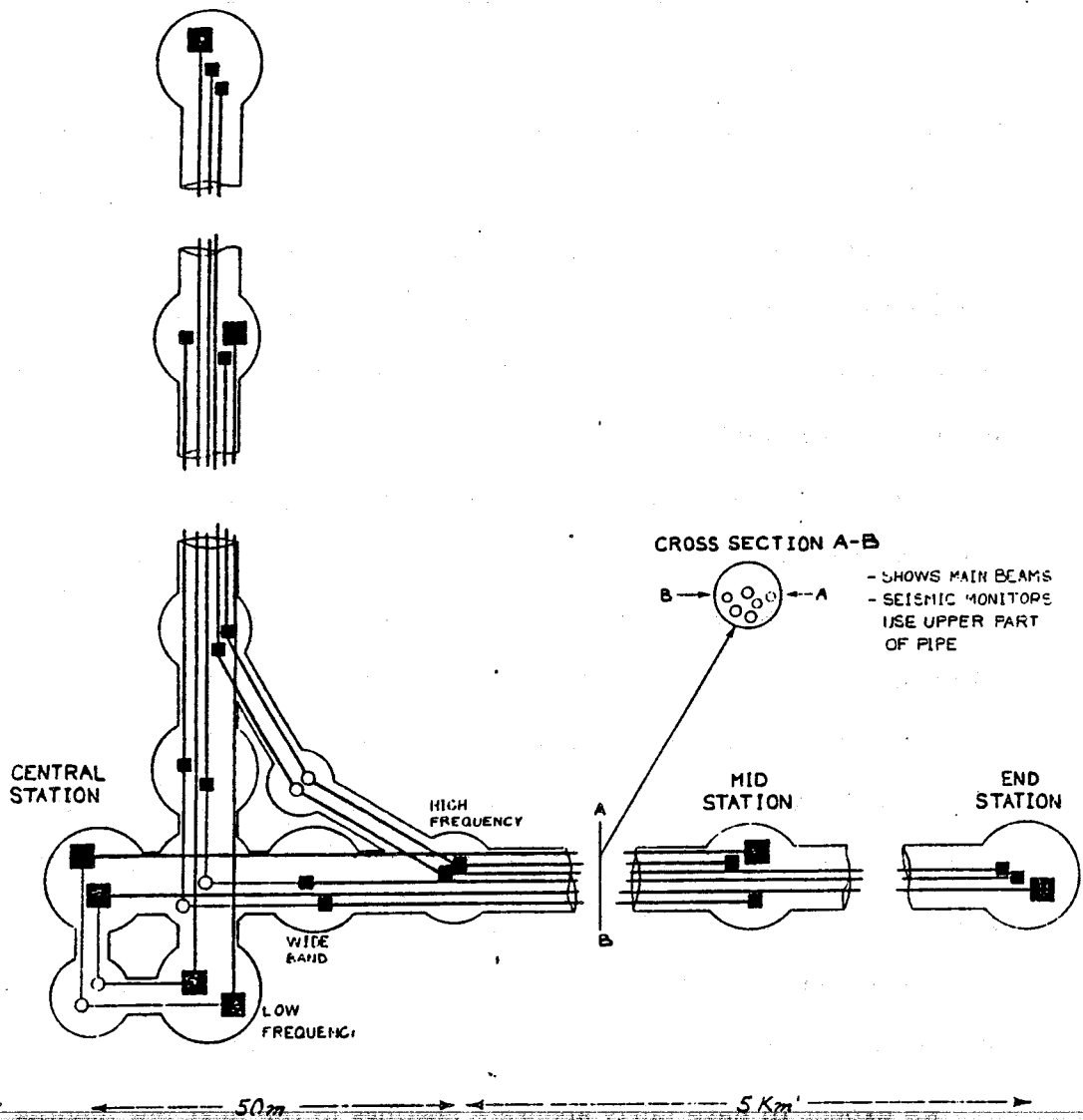

Figure 6.5 An example of how large diameter (≥ 1 m) pipe can be exploited to operate many interferometers simultaneously. Depicted here are three separated detectors, optimized for low frequency (≤ 100 Hz), high frequency (≥ 1 kHz), and wideband operation. Each detector consists of four interferometers: full-length and half-length for main beams monitoring the suspended masses as well as for auxiliary beams monitoring the suspension points.

supervision from Caltech and consultation from MIT.

6.3.2. Description of the JPL Study

Foremost of the new features being studied are the costs of the 10^{-8} torr vacuum required by the higher sensitivity goals, costs of the more elaborate vacuum tank systems required at the end and center stations to accommodate several simultaneously operating interferometers and several "mode-cleaning" cavities for improving the spatial stability of the laser beams; costs of the mid stations; and costs for isolation pads giving seismic isolation for the tanks containing the test masses.

These new-item costs are being evaluated not only by JPL, but also independently by A.D. Little. JPL is also reinvestigating possible construction methods, reviewing estimates of costs for other parts of the facilities, and carrying out a more detailed survey of possible sites. (The JPL team involved in this exercise is the one which designs and supervises the construction of deep-space-net antennas and antenna sites.) The sites now being investigated include some of those in the original Stone & Webster study, plus several new sites that are more convenient to MIT and Caltech: two in Maine; one in Massachusetts; and one at the Goldstone tracking station of the Deep Space Net, which has excellent support facilities and could probably be made available for this project quickly.

~~We expect to have fairly accurate costings in the next few months. These~~
will provide the data required for the realistic assessment of cost tradeoffs involved in arriving at an economically optimum set of parameters for the complete vacuum facilities.

We also expect to have enough information about sites within the next few months to permit a firm selection of two first-choice sites and two backup sites. This selection will be an important ingredient in the early stages of this proposal's engineering study.

7. PLANS FOR ARRIVING AT THE FINAL CONCEPTUAL DESIGN OF THE MAJOR FACILITIES

The key input to this proposal's engineering design study will be a final conceptual design for the major facilities. The final conceptual design will be arrived at this winter by the scientists of the Caltech and MIT gravity groups and the Project Manager. The decision process will begin with a joint meeting of the Caltech and MIT scientists at which presentations will be made by the JPL, A.D. Little, and Stone and Webster engineers who have performed the cost and site studies. The scientists will then consider various strawman designs and analyze them, and will carry out extensive discussions of the relative merits of various design options. The ultimate decision on the final conceptual design will be made, relying heavily on these discussions and analyses, by a Steering Committee consisting of R.W.P. Drever, R. Weiss, and K. Thorne.

Two fundamental principles will guide the decision making process:

- (1). The facilities design should not prejudice the decision on the optical design of the first antennas.
- (2). The facilities must be sufficiently flexible to function, with reasonable-cost upgrading, as a gravitational-wave observatory with a wide variety of possible antennas for 20 years into the future.

Within these guidelines, we will arrive at a conceptual design which is our best attempt to balance scientific opportunities and flexibility with cost and risk. The design will almost certainly include specific provisions for upgrading the facilities from the configuration used for the first experiments.

In addition to finalizing the conceptual design, the scientists of the two groups will prepare the System Functional Requirements to guide the engineering design contractor. These include:

1. Required vacuum levels.
2. Number of operating stations and their purpose.
3. Antenna length.
4. Antenna relative and absolute orientation.
5. Antenna alignment tolerances.
6. Vacuum pumpdown time.
7. Light baffling.
8. Vacuum pipe diameter
9. Permissible acoustic noise spectrum.
10. Permissible temperatures excursions.
11. Cooling system effects on operation.
12. Power requirements
13. Housekeeping data acquisition.
14. Intercommunications linkages.
15. Absolute time standard.
16. Anticipated facilities operation lifetime.
17. Local facility requirements.
18. Number of operating personnel.

On the basis of the site survey now being performed by JPL, the scientists of the two groups will select two first-choice sites and two backup sites. This will allow the engineering design to include the details of installation at the actual sites and will allow negotiation for site access to proceed during the engineering design study.

8. THE ENGINEERING DESIGN STUDY AND ITS IMPLEMENTATION

8.1. Introduction

The engineering design and feasibility study will be carried out by a Gravitational Wave Detection Facilities Project activity in residence at Caltech. If the project is approved for construction, this group would ultimately oversee the development, construction, and validation of the vacuum facilities. This step is necessary because of the extent of the proposed facilities and funds required to develop them. This Project activity is under the cognizance of a Project Manager reporting to the three-man Steering Committee (Drever, Weiss, and Thorne) described in the previous section.

The engineering design effort consists of two parts. The first is described in this section and is the detailed engineering design for two antenna facilities at selected sites. The aim of this work is to establish the design with sufficient detail to arrive at accurate and optimized costs and schedules so that a proposal for the implementation of the design may be evaluated. The engineering design will use a model for the implementation plan to arrive at a realistic assessment of the costs.

The second part of the effort is to carry out prototype development and tests of facility and receiver components which are crucial to the design of the ~~overall gravitational wave antenna system. These topics are discussed in~~ Chapter 9.

As discussed in Sections 6 and 7, the earlier MIT and current JPL studies are being used as a basis for the development of the final conceptual design of the major facilities. The JPL study includes an effort by the Ground Antenna and Facilities Engineering Section to survey potential sites and to prepare material which can be used to select, guide and monitor an industrial contractor whose

responsibility will be the engineering design of the major facilities (referred to henceforth as the "final system engineering design".)

The final conceptual design, which is our group's input to the engineering design effort, will consist of a functional requirements document based on the specifications listed in Section 7. Besides the specifications, the document will highlight a set of issues to be studied for trade off analysis during the course of the design. Many of the engineering problems have alternative strategies which will satisfy the same specification but which will have varying impact on the capital and operating costs of the facilities. Examples of such issues are the choice of high vacuum pumps, the choice of tubing material and manufacture, and the tubing alignment strategy, to mention just three. Some of the prototyping and testing effort described in Section 9 of the proposal is dedicated to obtaining information for the trade off analysis.

The product of the engineering feasibility design phase of the Project will be detailed engineering plans for those elements that have the greatest impact on Project resources: the vacuum system, instrumentation stations, electrical systems, etc. If necessitated by limited resources, design trade-offs will be made by the Steering Committee working with the Project Office. The Engineering Design phase is expected to take approximately 1½ years to complete.

The material which follows covers the basic approach to the Project. This ~~includes the responsibilities and relationships of the Steering Committee, the~~ Project Office, and its supporting groups, and resolution of the different means of establishing project feasibility. Additional material covered includes ground rules under which the Project Office will be established and operated, the mechanisms for Project control and monitoring, quality assurance and reliability, configuration management, reviews, and documentation.

8.2. Steering Committee

The Steering Committee has three members whose responsibilities will be outlined in a Memorandum of Understanding (MOU) between Caltech and MIT. This MOU will be finalized and signed before the Engineering Design phase begins. The present, tentative version of the MOU defines the responsibilities and relationships between the two Principal Investigators and methods for resolving in a timely way any differences between them. It also provides that the Steering Committee designate to act in its behalf on a day to day basis, a Principal Scientist for joint construction for the design and construction of the vacuum facilities and for the construction of the joint receiver elements, and that the Project Manager be responsible to the Steering Committee but interact on a day to day basis with this Principal Scientist. The MOU also provides that the Steering Committee designate a Principal Scientist for Experimental Techniques and Planning. The Project Manager will be a non-voting observer at Committee meetings except during executive sessions.

The balance of the MOU will describe the facilities to be constructed and the basic principles for joint Caltech-MIT management of the facilities after they are constructed.

Meetings of the Steering Committee will be held on a regular basis. Reports of the progress of the Project will be presented to the Committee on a monthly basis by the Project Manager.

8.3. Project Office

The Project Office is responsible for establishing, in conjunction with the two Gravity Wave Groups, the feasibility of designing and implementing the two Gravitational Wave Facilities. This includes finalization of the conceptual design, analysis of its feasibility, and if approved for implementation, construction of

the facilities through completion of receiver installation and performance verification.

To accomplish this a Project Team is being assembled. As shown in Figure 8.1, the Team is headed by the Project Manager, who reports to the Steering Committee. The Team is composed of three distinct groups:

1. a support activity previously discussed, provided by JPL under a Work Order;
2. a system technical and financial management group operating as part of the Project Office;
3. a group from each institution to provide scientific support to the Project.

The current JPL Work Order provides for a ten month effort to study potential approaches to the development of the Facilities. The work is being conducted under the cognizance of the JPL organization responsible for the implementation of NASA's Deep Space Network facilities. The group has an extensive background in the design, development, and construction of remotely located technical facilities. Their primary responsibility during the Conceptual Design Phase of the Project is divided into four tasks:

1. configuration definition, site selection and the design procurement package;
2. cost estimates for the final conceptual design and study effort;
3. analysis of the fabrication and construction effort; and
4. preparation of the design specifications and facilities performance verification.

Their responsibilities during the Engineering Design Phase will be to oversee the industrial contractor and to perform design analysis for the Project Office. If the implementation is approved they will oversee the effort of the construction

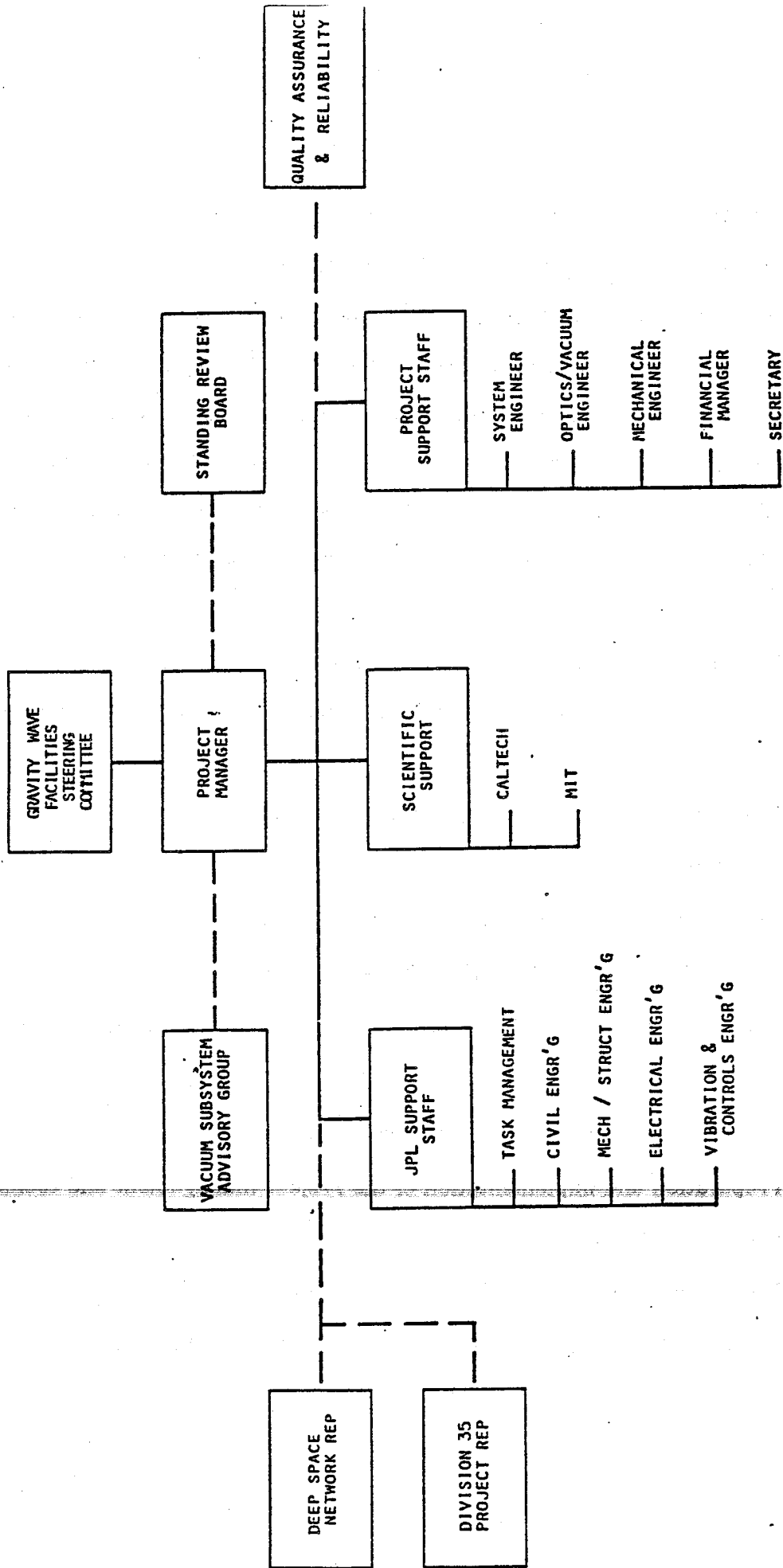

PRELIMINARY ORGANIZATION CHART
FIGURE 8-1

contractor(s).

The Project Office staff is responsible for facilities system engineering. The members of the staff include a systems engineer, a mechanical engineer, a vacuum/optics engineer, and a financial manager. The day-to-day interactions between the Project Office and the JPL support group will be conducted by the engineering staff. The financial manager will be responsible for tracking and controlling the resources allocated to the Project. Additional support staff will be added, if required, to ensure that the Project meets its obligations to NSF, Caltech, and MIT.

The activities of the Project Office during the Engineering Design phase, in addition to supervision of the Engineering Design contractor, include the following:

1. Incorporation of all functional requirements into the engineering design of the facilities.
2. Establishment of the criteria for the implementation verification process.
3. Participation in trade-off studies of the facilities.
4. Training of the Project and JPL support staff in the requirements preparatory to implementation.
5. Development of an overall, integrated system design for the facilities.
6. Preparation and implementation of the Project management and technical control processes.
7. Preparation of the Project Implementation Plan.
8. Design of the support subsystems and assemblies for the facilities.

9. Performing prototype testing of key hardware components which might be used in the facilities.

These activities should enable the Project to achieve its goals within estimated budgetary requirements and constraints. This early planning and system development should allow the Project to make a smooth transition from the Engineering Design phase to the Implementation Phase if the Project is approved.

The Project Office will prepare and issue a Gravitational Wave Project Implementation Plan to delineate the Project's approach to meeting the Functional Requirements for the Facilities. The Plan will be one of the major Project outputs of the Conceptual Design Phase. This document will also establish Project policy and requirements concerning the feasibility study and Implementation. This includes approaches to quality assurance and reliability, configuration management, materials and component parts application and usage, reviews, documentation, security and safety.

Of particular importance is the approach taken to development of a management structure that will allow the Project to be monitored and controlled. This will be accomplished using the following approach:

1. development of composite functional block diagram showing all subsystems at each site and development of subtier functional block diagrams of assemblies of the subsystems;
2. preparation, using the functional block diagram, of a Work Breakdown Structure (WBS) that lists in a hierarchal manner all elements of the facilities for each phase of the Project. The initial construct of the Project WBS is shown in Figure 8.2;

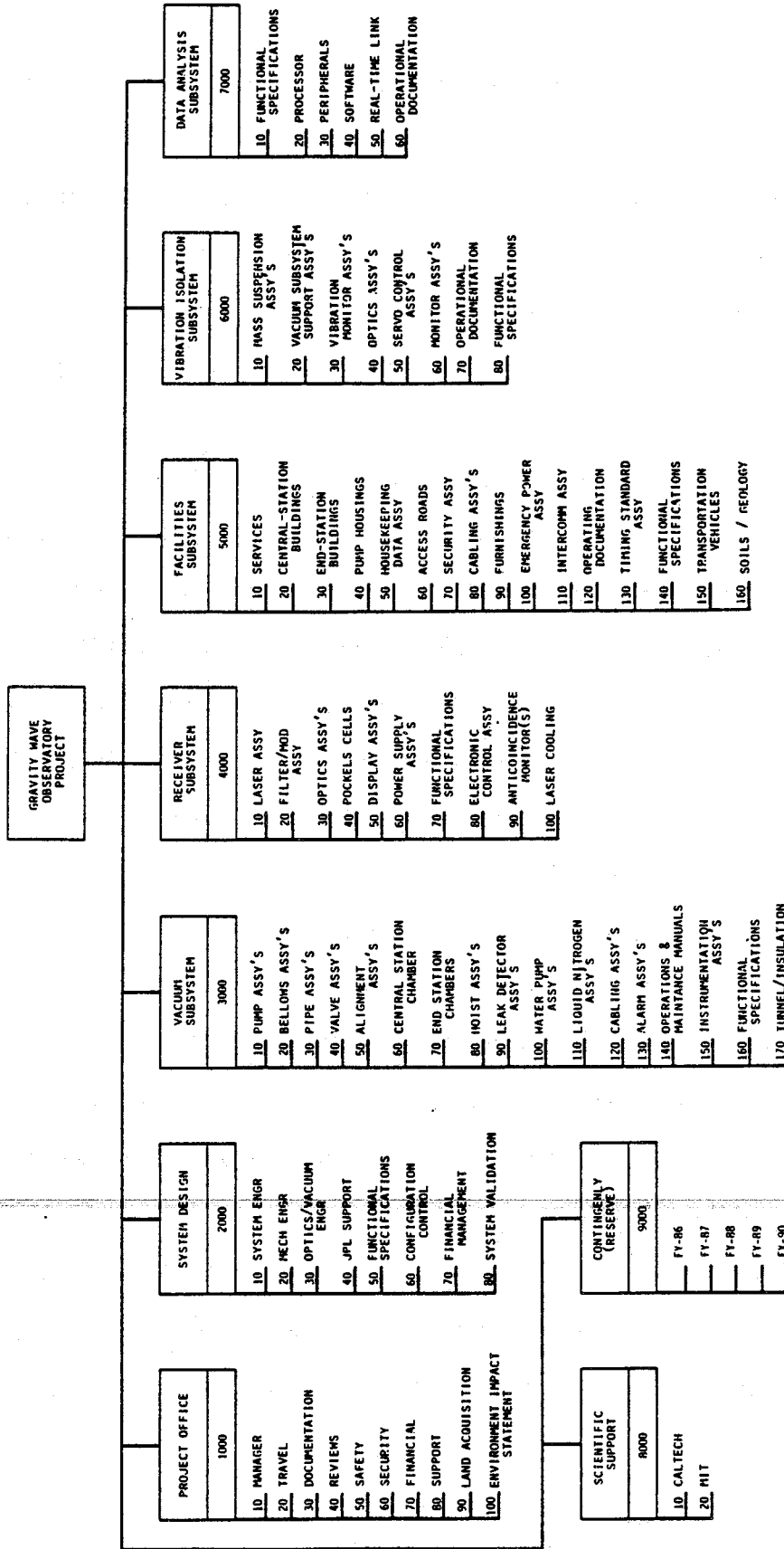

THIRD LEVEL TASK BREAKDOWN STRUCTURE
FIGURE 8-2

3. preparation of functional descriptions of each of the elements of the WBS; (Scientific support, particularly in making design tradeoffs, will be obtained from both MIT and Caltech Gravity Wave Groups. Close interaction with both Groups will be required throughout the Project.)
4. generation of schedules describing the duration and activity involved in each element of the WBS, Figures 8.3A (a long range schedule has been included for information purposes only) and 8.3B; and
5. preparation of an overall cost estimate for the Project using time-related WBS elements.

The importance of this approach is that only through the preparation of a composite set of related documents can an effective resource monitoring and control effort be established. These related documents comprise a Baseline Plan against which progress will be monitored and reported. The Baseline Plan will be updated periodically to reflect any substantial modifications. Schedules will be detailed for six month intervals and updated each three months.

The Work Breakdown Structure shown in Figure 8.2 has been set up to identify the elements of the facilities. This WBS contains all elements of the Project to allow for the crossover from the Conceptual to the Engineering Design and Implementation Phases. The breakdown is tentative. As the design becomes more specific the WBS will be enhanced and expanded to lower levels to reflect these changes. The particular arrangement of the elements of the WBS is not important, there are several possible arrangements that would work equally well. The critical issue is that any elements of the facilities that have cost implications must be contained on the WBS. Each element of the WBS is uniquely identified so that an automated cost and schedule control mechanism can be implemented. Current consideration is being given to the use of either PMSII/RMS-II or Quicknet programs to provide data for this control. Both of

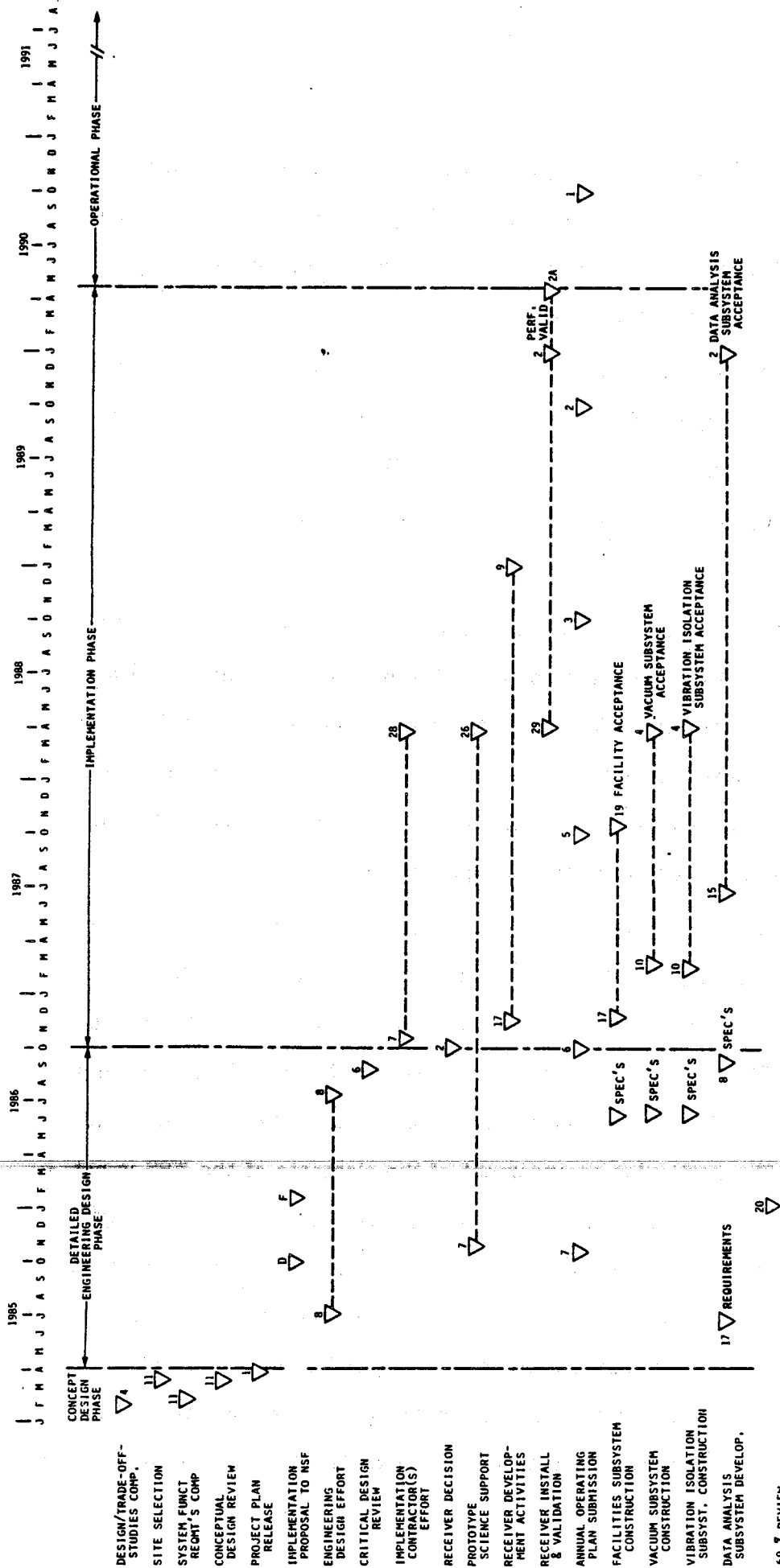

PRELIMINARY LONG RANGE PROJECT SCHEDULE
FIGURE 8-3A

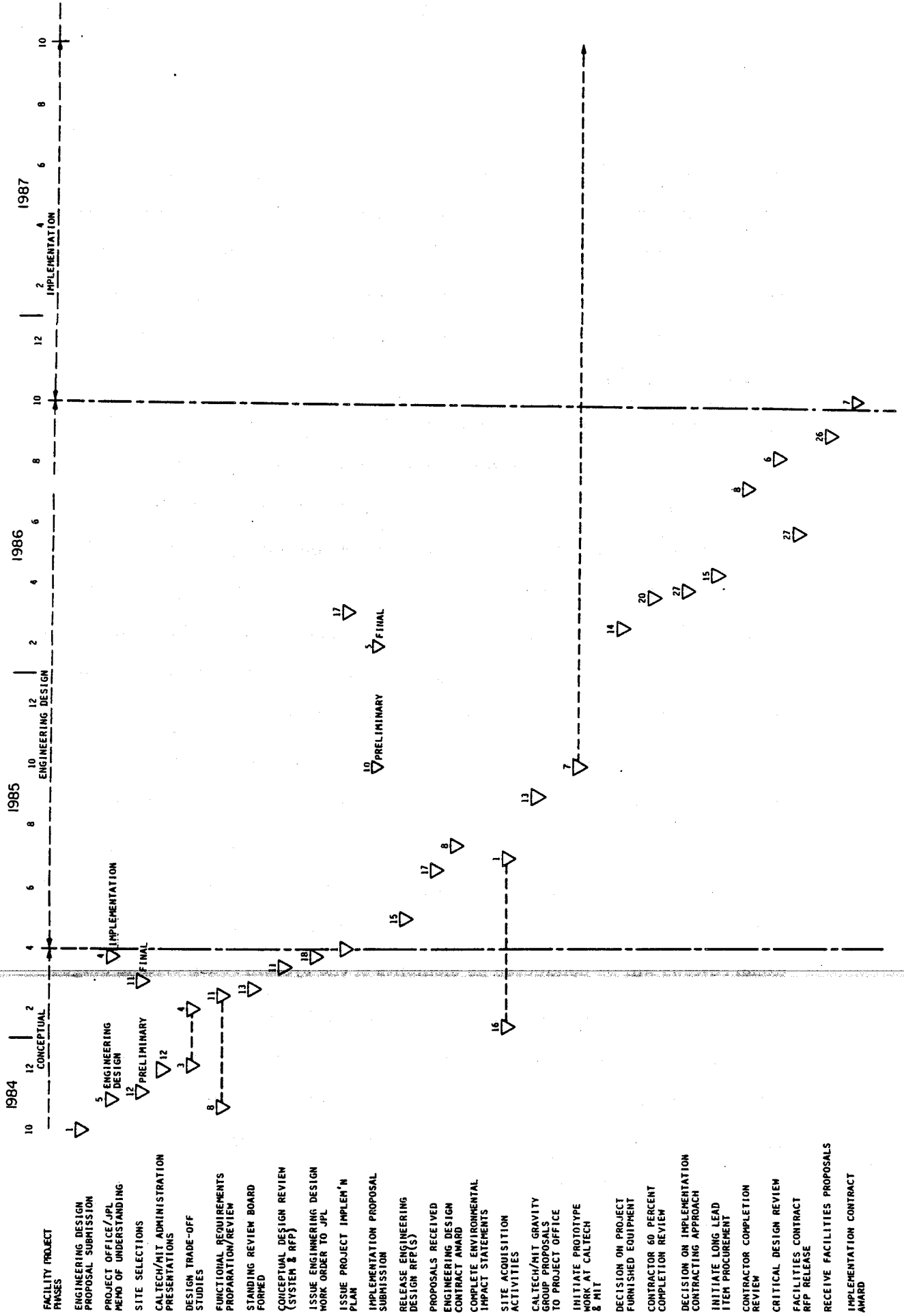

PRELIMINARY NEAR TERM PROJECT SCHEDULE
FIGURE 8-38

these programs have the capacity to handle this project. The numerical identifiers used to distinguish WBS elements will be revised to reflect the specific project monitoring and control program selected. Note that the WBS contains both level of effort and product specific activities. The level of effort tasks will be tracked on a straight line basis, unless there is an identified deviation in the Plan. The product oriented tasks will be assessed on an actual cost/schedule basis versus that planned.

A Standing Review Board will be established during the Conceptual Phase of the Project to advise the Project Manager of any problems that are detected during the review process. To the maximum extent possible the Board will be drawn from technical and management personnel having experience in the technology being implemented; it will also include representatives appointed by Caltech and MIT. This Board will attend all formal reviews held by the Project. It is their function to comment to the Project Manager on the conduct of the Project, especially in regard to activities within their speciality.

There will be two formal reviews conducted during the Conceptual and Engineering Design Phases; the first will be the review of the material included in the Requests for Procurement (a Conceptual Design and RFP Review) to the industrial contractors and the second (a Critical Design Review) will occur at the conclusion of the work performed by the Engineering Design contractor. Additional reviews will be conducted as elements of the system reach critical stages.

A Vacuum Subsystem Advisory Group is being established by the Project Manager to advise him on approaches to the implementation of that subsystem. This group is composed of specialists drawn from members of the JPL staff and commercial organizations. It is their function to serve as a resource base for the development of the vacuum facilities. Additionally, they will serve as the primary reviewers of any vacuum implementations proposed by the industrial

contractor, reporting to the Project Manager.

One of the functions of the Project is to identify any trade-offs in approach, scoping the potential impact on the Project and identifying a schedule for decisions to be made. As a part of this activity the Project will provide the Steering Committee with data relating the impact of each particular approach on resources. Because of the fixed-price nature of the contracts to be awarded to commercial organizations for elements of the system, the decision making process must be in place sufficiently early in the program to allow necessary action to take place before any contract awards..

9. PROTOTYPE TESTING AND EVALUATION

The proposed prototype testing and evaluation is to be carried out in parallel with the activities of the engineering design study. This activity is to be implemented by the Project Office through the Caltech and MIT Gravitational Wave Groups. We will be testing critical components in two key areas: the vacuum system and the optics.

As described below, tests of individual vacuum components (tubes, bellows, valves, and pumps) will be performed early. This will enable us to select with some degree of confidence the technology which will appear in the facilities engineering design. The second phase of vacuum prototyping will be the construction of a model vacuum system using full-scale components of the type specified in the engineering design. This will allow a validation of the design before the commitment of large sums for the construction of the long-baseline systems. As a result, we will be able to write tightly specified fixed-price contracts for the vacuum system, and contractors will be able to bid on them with confidence that the technology exists to meet the specifications. Thus we expect this testing and design validation effort to be an important cost saver for the project.

The optics testing will examine the critical receiver components, chiefly lasers and mirrors. Several approaches to achieving powerful lasers will be pursued in parallel. Similarly, prototype high performance mirrors appropriate for long baseline systems will be acquired and tested. Finally, integrated high-power long focal length optical systems will be tested in the lab scale vacuum facilities available to us. By virtue of this test program, we ought to be able to construct receivers for the long-baseline systems, upon project approval, without fear of technical surprises.

9.1. Vacuum System Evaluations

The vacuum system for the facilities is the critical element of the facility design. Approximately half of the capital costs for the gravitational wave detector facility is in the vacuum system. Many large vacuum systems have been constructed and vacuum technology is not considered a high risk aspect of the facilities engineering, as is indicated by the A.D. Little study. There are, nevertheless, substantial extrapolations being made which have not been tested simultaneously in the heritage derived from vacuum systems used in particle accelerators, plasma physics experiments and space simulators. For this reason, we feel it is prudent to undertake a program of vacuum component tests and system prototyping. This will enable us to better understand the trade-offs between capital cost, operations cost, and reliability of the vacuum system.

9.1.1. Prototype Vacuum System

We will construct at MIT a small scale vacuum system of the same design and using the identical components as those specified for the large-baseline facilities. This test system would be constructed of samples of the components to be used on the large antenna: one section of the tubing, one bellows, one gate valve, one instrumentation station, and the candidate high vacuum pumps. The test system would indicate if there are flaws in the design and would be made sufficiently flexible to allow substitution of components should there be difficulties with the initial choice of component or if ancillary tests indicate that there are cost savings that could be made by trying other procedures or by the use of other components. The questions that a test system will help to answer include:

1. The ultimate system operating pressure.
2. The molecular constituents of the residual gas. The atomic and molecular polarizability of the gas at the laser frequencies is important in determining the magnitude of the index fluctuations that will affect the gravitational-wave measurements and ultimately sets the vacuum specification.
3. The short period pressure fluctuations in the vacuum. The power spectrum of gas pressure fluctuations is rarely measured in vacuum chambers but is important in the gravity-wave experiments. The temporal behavior of the outgassing as a function of temperature sets requirements on the temperature excursions of the vacuum system; furthermore one of the critical parameters in the choice of the high vacuum pumps is that they be free of generating gas bursts and should not exhibit rapid fluctuations in pumping speed.
4. The quiescent outgassing rate of the tubing as a function of temperature and the change in this rate as a function of low temperature baking or pre cleaning procedures. The vacuum system design will make initial assumptions on the outgassing rate which determines the number of pumps required to establish the ultimate design pressure. This calculation is the most uncertain of the many required to design the system, and there could be real economic benefits in reducing the uncertainty by measurements.
5. The porosity characteristics of the specific tubing design. The manufacture of the tubing and the material have a strong economic impact on the vacuum system cost (described below). The test vacuum system will be used to characterize the performance of several of the candidate tubing designs.

6. The leak rate and outgassing characteristics of the gate valves. The gate valves that separate the long tubes from the instrumentation stations are both critical and questionable components of the vacuum system design. Large valves are notoriously troublesome especially as the ultimate pressure demanded gets below 10^{-8} torr. They are furthermore expensive. The sample vacuum system will be used to make functional tests of several commercially available gate valves of the aperture required for the large baseline system to verify performance in terms of reliability over long periods of time. We will additionally try to establish new mechanism and maintenance requirements.

9.1.2. Vacuum Tubing

Although the technology of tubing manufacture is well established, the gravity wave facilities will impose demands on the tubing quality which could be difficult to meet economically. The large diameter and the low pressure are the technological drivers.

The A.D. Little vacuum system study recommended aluminum tubing rolled from sheet and welded. The design incorporated periodic stiffening rings to avoid buckling and tube collapse under atmospheric pressure load. Part of the decision to recommend aluminum was derived from the success of new techniques to perform automatic heliarc welding both in plants and in the field. Subsequent studies favor stainless steel and there is at present no compelling argument to reject either material. A major issue which is beginning to emerge is the ease with which to manufacture tubing from metal ingot and be assured of no porosity in the base metal itself. Stainless steel, although more expensive than aluminum, may be more trouble free in this regard. Whether is to be rolled and welded or extruded in one piece is an important question which affects

overall costs in a complicated way. Tubing that is rolled and welded is substantially cheaper to manufacture than extruded tubing, but it is also more likely to have leaks and therefore be more expensive to test and seal.

Another engineering factor is the ability to preclean or clean the tubing after assembly to reduce the outgassing rate without having to resort to heating the pipe after installation. Techniques for cleaning tubing have been studied in the particle accelerator laboratories, but never on the scale required for the gravity antenna facilities.

For these reasons, as well as to be able to write proper specifications for fixed cost contracts, we intend to carry out an engineering research program with tubing manufacturers to verify cleaning procedures, test welds and weld inspection techniques. We will also test the porosity at the very low levels required of several tubing manufacturing techniques. The selected tests of the tubing and cleaning techniques will be performed first in the prototype vacuum system.

9.1.3. Bellows, Valves, and Pumps

a) Metal Bellows

Metal bellows are essential components in the vacuum facilities to allow for ~~thermal expansion and atmospheric pressure compensation at the instrumentation stations.~~ Small metal bellows made of brass, stainless steel, and various cupro-nickel alloys are standard laboratory items. The large bellows needed for the large baseline antenna facilities are less common and more experience is needed to understand their properties. The decision on the tubing material is also related to the choice of material of the bellows. If aluminum is chosen as the tubing material there may be a significant cost advantage in using aluminum

bellows to avoid transition pieces between the bellows and the tubing. Aluminum bellows have only recently become available and must be tested. Another consideration is the potential need for flanges in the bellows attachment. The ability to weld bellows directly to the tubing reliably may offer some risks, but it also has a impact (potential reduction) on costs and could result in greater reliability of the vacuum system. The question that has to be addressed is the difficulty of reliably welding a thin bellows to a thicker tube.

The project will purchase bellows of several designs and material and evaluate them and the methods of attachment. The final tests of the bellows performance will be made in the prototype vacuum system.

b) *Gate Valves*

The gate valves, as has been indicated above, are troublesome components in the vacuum system design. The standard gate valves using vacuum grease and elastometer seals will work well at pressures above 10^{-6} torr. The gravitational antenna project requires several properties valve that are not normally encountered. The pressure in the instrumentation stations could be as low as 10^{-8} torr and the pressure in the long arms between 10^{-6} torr to 10^{-8} torr. The valves will therefore require low vapor pressure sealing surfaces and bellows couplings for the actuators. The valves will be operated frequently in the early part of the project and there will doubtless be substantial need to get into the instrumentation stations often. In later phases, especially during operation of multiple interferometers, it will be important to keep some experiments running while others are being installed or checked out. The long term reliability of the valves is a critical question for operational reasons alone.

The project intends to buy and test gate valves of several manufacture. We will cycle valves and test their ability to withstand atmospheric pressure on one

side and high vacuum on the other. The valves that appears to be the best candidates will be fully tested in the prototype vacuum chamber.

c) *High-Vacuum Pumps*

The A.D. Little vacuum system study specified ion pumps as the baseline for the gravitational wave antenna facilities. The prime reasons for this choice is their reliability and freedom from maintenance as well as the fact that they are mechanically quiet. The ion pumps, especially if started at pressures above 10^{-3} torr, have a reputation of causing gas bursts which may be of sufficient size to cause noise in the gravitational wave search. Several manufacturers indicate that with specific cathode designs the gas bursts do not occur. The power spectrum of the pressure fluctuations due to these pumps must be measured to establish if they can be used in the facilities.

An alternative to ion pumps are cryosorption pumps which have higher pumping speeds than the ion pumps and potentially lower ultimate pressure. The pumps have closed cycle refrigerators associated with them that brings into question the vibration induced by the pumps as well as their long term reliability.

The project will purchase several ion pumps and these will tested in the prototype vacuum chamber. If the pumps do not satisfy the requirements, a cryo-pump will be purchased and tested in the same system.

9.2. High Power Laser Contracts

Laser sources for the receivers to be installed in the large baseline antennas have to meet a set of stringent requirements to meet the projected sensitivity goals for either cavity or delay line systems. The requirements are:

1. High power output in a single transverse and longitudinal mode. 1 to 10 watts is required, but over 100 watts would be desirable.
2. The intrinsic Amplitude and Frequency modulation of the laser carrier should be as small as possible even though servo systems are used to reduce both of these modulations.
3. The laser efficiency (the conversion of input power to light power) should be as high as possible. This requirement clearly has an effect on operations costs and could become a limiting factor on the number of interferometers that can be operated simultaneously in the facilities, both as it affects the facility power budget and the laser cooling systems.
4. The laser must be reliable and able to run for long periods (months) without service or replacement of parts.

The laser system that is being used in the prototype receivers is the argon-ion laser which, in single commercially available units, is able to produce between 1 to 5 watts in a single mode in the green. Several schemes are now being attempted to increase the power by adding the output power of several lasers together coherently (See Section 9.5). For laboratory prototype purposes, to test optics and to increase the sensitivity of the receivers, these schemes are the best short term solution.

In order to achieve high power, reliability, and efficiency, it is important to ~~take advantage of recent advances in laser technology. The MIT group will take~~ the lead in this effort, in a cooperative program with laser manufacturers. Two different technologies will be pursued. The first is the development of larger bore diameter Argon-ion laser tubes. The second is the development of the Nd:Yag solid state laser system.

a) *Argon-ion Laser Development*

The argon-ion laser used in the prototypes has an efficiency approaching 10^{-4} . The experience gained in prior work on multi-mode high power argon lasers indicates that large bore diameter, 1 cm, discharges are 10 to 30 times more efficient than the smaller diameter tubes now being used in the commercially available argon lasers. This is due to the more efficient discharge conditions in the larger bore tubes and the fact that radiation trapping is not the bottleneck in depleting the lower laser level in the argon laser. A scheme that has been discussed with industry (Mathematical Sciences Northwest-Spectra Physics) is to develop a large bore argon discharge tube as an amplifier for a commercially available argon laser. The amplifier would be 150 cm long and the discharge volume would be filled by the output power of the oscillator which is operating in a single mode. Such a system could produce 150 watts of single mode power at an efficiency of 5×10^{-3} .

b) *Nd:Yag Laser Development*

The Nd:Yag laser system has not been used for precision laser applications but, it is enormously more efficient than the Argon laser, efficiencies in CW operation of 2% have been reported in multi mode systems delivering 400 watts and higher. These lasers have undergone rapid development in the past few years with the application of slab geometries and zig-zag beam paths in the gain medium. Although most of the development has been for high power in military and industrial applications, there is some research going on in particular at Stanford University under Professor R. Byer, to develop single mode frequency stabilized Nd:Yag systems in this case for space applications. The system being tried at Stanford is to incorporate the Nd:Yag gain medium in a ring resonator geometry to avoid spatial hole burning and mode competition.

The Nd:Yag laser produces 1.06 micron radiation which is suitable for the gravity wave experiments and, if need be, green light can be generated by frequency doubling. We have contacted General Electric, the major developer of the high power Nd:Yag system, and Coherent Technology, who will begin marketing the GE lasers commercially during the course of the next year. Both companies are willing to provide components and assistance in developing a Nd:Yag system appropriate to the needs of this project.

9.3. Test Masses and Optical Systems

One means for establishing feasibility and design of the large-scale antennas will be the development and experimental testing of optical systems, test masses, and as far as possible, complete antennas in the 40 meter vacuum system at Caltech. In order to make operation of the full-size test masses and optics in the 40 meter system simulate as closely as possible operation over a 5 km baseline, we would plan to fit them with mirrors and mode matching lenses having radii of curvature chosen so that the diameter of the beam over the 40 meters matches approximately the diameter in a 5 km system. The laser bank proposed in Section 9.5 can be used to give the same power density on the optics as in the large-scale system. It will also enable us to analyze some possible effects of surface errors in the mirrors, lenses, polarizers, and other optical components to be tested. Experimental tests of suspensions and isolation systems will be performed in the same apparatus, and these will extend to tests of overall displacement noise, including thermal noise in the masses and suspensions and other stochastic noise sources.

The vacuum pipes in the present 40 meter system are already large enough to accommodate the beam diameter required by a Fabry-Perot cavity or other compact optical system over 5 kilometers. Larger end tanks are needed to

accommodate the more widely spaced suspended optical block and test mass structures planned for the large antennas. This would also permit operation of the larger size test masses and associated suspensions required for experiments at lower frequencies. Additional vacuum pumping will have to be installed to permit operation at the lower pressures required for some of the experiments, particularly when simulating searches for low frequency gravitational radiation, where Brownian noise from residual gas acting on the test masses may be significant.

9.4. Mirrors

9.4.1. Fabry-Perot

The availability of mirrors having very low optical losses is of great importance for the high performance interferometers planned, as already discussed earlier in this proposal. The development of special high-reflectivity mirrors for use in laser gyroscopes has produced mirrors having losses of less than 1 part in 20,000 - and possibly even better than this - and these should make possible the techniques of recycling the light, and use of resonant optical systems to enhance sensitivity for periodic signals, described earlier. Currently, however, the laser gyroscope application has only required mirrors of diameter about 2 cm, and the mirrors used in the tests with the Caltech 40 meter system were specially made with a diameter of 4 cm. For a 5 km system with Fabry-Perot or other compact optics, the required diameter for diffraction losses of less than 10 parts per million is 15 cm (allowing some unused area near the edge of the mirror). We have been assured by the manufacturers of the mirrors tested so far that they can make mirrors of this size using existing equipment and techniques, and envisage no problems in doing this. However it will be important to

have some mirrors made of this size sufficiently during the feasibility phase to check the losses in practice and to test for coating uniformity and errors in mirror figure which may affect mode matching in simple interferometers, and possibly degrade overall efficiency in recycling systems. It will also be important to study operation with high laser powers and correspondingly large stored energy in a Fabry-Perot system, to test for thermal distortions and radiation damage effects. (It is known that the coatings we are using have good resistance to radiation damage, but the power levels which may be involved here can be very high). For these purposes we plan to place a contract with the manufacturer of our present mirrors for development of the polishing and coating techniques for mirrors of this size, and for manufacture of prototype mirrors for testing. Since these mirrors are so critical for certain aspects of our project we plan to place a contract with another possible source of this type of low-loss mirror, as a backup and also to allow comparison with the products of our current source. Many of the tests we plan to make on these mirrors will be made with the 40 meter interferometer system at Caltech, upgraded with larger vacuum tanks and with pumps for lower pressures, as mentioned in Sections 9.3 and 9.5.

9.4.2. Michelson

Mirrors for a first generation receiver using delay line optics would have diameters ranging between 20 to 40 inches. The mirror focal length would be of the order of the 5 km arm length. In a 5 km system the mirror sagitta for a 20 inch diameter mirror would be about 10 microns, the mirror is virtually flat. The small sagitta does not pose a problem to mirror manufacturers, but the tolerances on figure and slope error may prove troublesome. The focal length of the mirrors must be maintained equal to 0.1% to allow the optical paths in the two interferometer arms to be adjusted to equally. Large wave length surface

ripples on the mirror should not cause slope errors exceeding a few microradians and, finally, the local surface roughness should not exceed $1/30$ of a wavelength over the dimensions of the Gaussian spot diameters.

Several mirror manufacturers have indicated that such mirrors can be ground, but will be difficult to test (SSG, Perkins Elmer, Itek). The mirrors can be coated with conventional multielectric with reflectivities greater than .99 (OCLI), but there is at present no plan known to us to perform tests of the ultra high reflectivity coatings on such large mirrors.

The project will purchase two 30 inch diameter mirrors of ULE silica for test. The tests can be performed interferometrically to establish that the mirrors meet the specifications.

9.5. High Power Optical Tests

A major area of development required of the interferometer systems is the step up of their operating power. The large-scale detectors will have input laser powers of order 10 watts or more, and with low loss optical systems and possible use of recycling techniques, very large circulating light power will result. Although others' experience with high power optical systems lead us to believe that we can cope with such power levels, further tests and development in this critical area are clearly desirable. Radiation damage effects in mirrors, pockels cells, polarizers, and other components may be important. There may also be technical problems connected with the use of low-noise sensitive photodiodes in situations where damaging light levels may occur if the system jumps from a dark to a bright fringe - and we plan use of fast-acting electro-optical shutters to protect the photodiodes in these situations. All of this requires experimental development and testing to establish feasibility and optimum choice of techniques, and we plan to do this using the upgraded Caltech 40 meter system as a

convenient test-bed.

To permit these optical tests to be performed at the required operating power levels, we propose to purchase a bank of argon-ion lasers with associated single mode etalons, phase locking pockels cells, etc., for use on the 40 meter system. These lasers have to be phase locked together and also locked in frequency to our interferometer cavities, so that their outputs may be added coherently. We will probably have to build the phase locking system ourselves for such systems are not commercially available. The same system can serve as a back-up high-power light source for the large-scale interferometers. but we anticipate that specially developed lasers will be ready by that time, and they would give increased efficiency and reduced operating costs.

10. BUDGETARY ESTIMATES OF ENGINEERING DESIGN AND FEASIBILITY STUDIES

10.1. Introduction

The estimated costs of the Engineering Design Phase (engineering design and feasibility studies) discussed in prior sections of this proposal are contained in this section. The Engineering Design Phase costs are based on an in depth assessment of the effort required to minimize risk in the implementation phase.

The approach to the Engineering Design is through a Project Office, in residence at Caltech, representing both Caltech and MIT. The additional support required by the Project Office to meet it's commitments will be supplied by the Jet Propulsion Laboratory. The responsibilities and functions of both of these groups were outlined in the preceding section.

10.2. Engineering Design Phase Cost Estimates

The Engineering Design Phase of the Project will be used to establish the detailed design feasibility of the Gravity Wave Facilities and to do the planning and design necessary to transfer from the Engineering Design to the Implementation phase of the program, if the Implementation phase is approved by the National Science Foundation. The input to this design is the result of on-going activities at Caltech, MIT and JPL to further refine and understand the estimates resulting from the A.D. Little/Stone & Webster study.

In addition to these activities, and to minimize overall project risk, some prototype testing of potential components for use in the facilities will be undertaken during the Engineering Design Phase. Specific uncertainties still exist in a number of areas and it is felt that evaluating and testing some of these elements prior to the award of contracts for implementation is essential. The removal of as many uncertainties as possible should reduce the value of the fixed price

contracts expected to be awarded and/or reduce system implementation risk. The resources estimated for these elements are educated guesses based on interactions with a number of potential contractors; none of them are firm quotations. This prototype testing and its purpose was described in preceding sections.

This prototype testing is felt to be prudent in light of some of the existing uncertainties, especially our strong desire to award fixed price contracts for the implementation of the Facilities. Based on engineering services from Stone & Webster, plus the cost of the Project Office and prototype testing activities, the estimated Engineering Design Phase costs in 1984 dollars, are:

June 1, 1985 to October 31, 1985	\$1,000,000
November 1, 1985 to October 31, 1986	\$5,700,000
Total estimated Engineering Design Costs:	\$6,700,000

Of the requested funds, \$2,810,000 is the estimated cost of the Project Office and contractor Engineering Design activities. The original (non-binding) estimate for the cost of the Engineering Design, by Stone & Webster in 1983, has been inflated to 1985 dollars, yielding an estimated cost of \$1,150,000, which is included in the \$2,810,000. Informal estimates by concerns other than the Stone & Webster group have been at levels \$200,000 - \$500,000 above the inflated Stone & Webster estimate. It is this uncertainty that prompts the Project to request that a contingency be included in the funds estimated to be required in fiscal year 1986. Any unused contingency will be applied to additional prototype evaluations. Our past experience with informal estimates leads us to suspect that the formal quotations will be somewhat higher. If the Engineering Design contractor assumes that it will be the Implementing contractor - something that is not clearly established at this time - then these cost estimates may be

somewhat lower. The uncertainty in how one will handle these issues will be resolved before award of the Engineering Design contract, but we will still leave open the option of reversing that decision depending on the selected Engineering Design contractor's performance, both technically and financially. The Summary Proposal Budgets are given in Section 10.5.

The total estimated cost of the Engineering Design phase listed above is in excess of the original budget estimate because of the detailed planning necessary to establish feasibility and minimize risk. The elements that make up this additional cost factor were discussed in the preceding section. Additionally, the original estimate assumed that there would be a smaller planning and monitoring effort than is considered necessary for the contemplated facilities. Another factor is that, because fixed-price contracts will be used as the primary contracting vehicle, it is vital that the implementation plans be as complete as possible prior to issuing any requests for proposals to industrial contractors. This early planning is essential to preclude subsequent changes which would could negatively impact Project resources.

An independent estimate of the Project implementation costs will be funded in early 1986. This estimate, to be completed prior to initiation of any full-scale facilities implementation, will be compared to the estimates developed by the Engineering Design Contractor and JPL. Any difference in these estimates will be evaluated and discussed with the National Science Foundation.

10.3. PROPOSAL BUDGET IN NSF FORMAT

		FOR NSF USE ONLY			
ORGANIZATION		PROPOSAL NO.		DURATION (MONTHS)	
CALIFORNIA INSTITUTE OF TECHNOLOGY				Proposed	Granted
PRINCIPAL INVESTIGATOR/PROJECT DIRECTOR		AWARD NO.			
R.W.P. DREVER, CALTECH / R. WEISS, MIT					
A. SENIOR PERSONNEL: PI/PD, Co-PI's, Faculty and Other Senior Associates (List each separately with title; A.6. show number in brackets)		NSF FUNDED PERSON-MOS. CAL. ACADSUMR		FUNDS REQUESTED BY PROPOSER	FUNDS GRANTED BY NSF (IF DIFFERENT)
1. R.W.P. DREVER, PROFESSOR OF PHYSICS, CALTECH (CO-PI)				\$	\$
2. R. WEISS, PROFESSOR OF PHYSICS, MIT (CO-PI)					
3. FRANK SCHUTZ, PROJECT MANAGER					
4. PAUL LINSAY, PETER SAULSON, ROBERT SPERO, STAN WHITCOMB (CO-I)					
5. () OTHERS (LIST INDIVIDUALLY ON BUDGET EXPLANATION PAGE)					
5. (6) TOTAL SENIOR PERSONNEL (1-5)				104,812	
B. OTHER PERSONNEL (SHOW NUMBERS IN BRACKETS)					
1. () POST DOCTORAL ASSOCIATES					
2. (5) OTHER PROFESSIONALS (TECHNICIAN, PROGRAMMER, ETC.)		85		262,730	
3. () GRADUATE STUDENTS					
4. () UNDERGRADUATE STUDENTS					
5. (1) SECRETARIAL-CLERICAL				27,950	
5. () OTHER					
TOTAL SALARIES AND WAGES (A+B)				395,492	
C. FRINGE BENEFITS (IF CHARGED AS DIRECT COSTS) @28.5%				112,716	
TOTAL SALARIES, WAGES AND FRINGE BENEFITS (A+B+C)				508,208	
D. PERMANENT EQUIPMENT (LIST ITEM AND DOLLAR AMOUNT FOR EACH ITEM EXCEEDING \$1,000:)					
TOTAL PERMANENT EQUIPMENT					
E. TRAVEL 1. DOMESTIC (INCL. CANADA AND U.S. POSSESSIONS)		48,245			
2. FOREIGN		9,235			
F. PARTICIPANT SUPPORT COSTS					
1. STIPENDS \$ _____					
2. TRAVEL _____					
3. SUBSISTENCE _____					
4. OTHER _____					
TOTAL PARTICIPANT COSTS					
G. OTHER DIRECT COSTS					
1. MATERIALS AND SUPPLIES		9,420			
2. PUBLICATION COSTS/PAGE CHARGES		40,425			
3. CONSULTANT SERVICES		18,700			
4. COMPUTER (ADPE) SERVICES		23,050			
5. SUBCONTRACTS (SEE ATTACHMENT A)		4117,240			
6. OTHER (IPI SUPPORT WORK ORDER/CONTINGENCY)		1444,490			
TOTAL OTHER DIRECT COSTS		5653,325			
H. TOTAL DIRECT COSTS (A THROUGH G)		6219,013			
I. INDIRECT COSTS (SPECIFY)					
INSTITUTE INDIRECT COST @ 53% ON ALL EXCEPT AS					
TOTAL INDIRECT COSTS INDICATED ON ATTACHMENT A AND EXCEPT G.6		480,987			
J. TOTAL DIRECT AND INDIRECT COSTS (H + I)		6700,000			
K. RESIDUAL FUNDS (IF FOR FURTHER SUPPORT OF CURRENT PROJECTS GPM 252 AND 253)					
L. AMOUNT OF THIS REQUEST (J) OR (J MINUS K)		\$ 6700,000			
PI/PD TYPED NAME & SIGNATURE*		DATE	FOR NSF USE ONLY		
			INDIRECT COST RATE VERIFICATION		
INST. REP. TYPED NAME & SIGNATURE*		DATE	Date Checked	Date of Rate Sheet	Initials - DGC
					Program

APPENDIX V

6/1/85 - 10/31/85 PROPOSAL BUDGET

ORGANIZATION		FOR NSF USE ONLY			
		PROPOSAL NO.	DURATION (MONTHS)		
PRINCIPAL INVESTIGATOR/PROJECT DIRECTOR		AWARD NO.	Proposed		Granted
CALIFORNIA INSTITUTE OF TECHNOLOGY					
R.W.P. DREVER, CALTECH / R. WEISS, MIT					
SENIOR PERSONNEL: PI/PD, Co-PI's, Faculty and Other Senior Associates (List each separately with title; A.6. show number in brackets)		NSF FUNDED PERSON-MOS		FUNDS REQUESTED BY PROPOSER	FUNDS GRANTED BY NSF (IF DIFFERENT)
		CAL.	ACAD.	SUMR	
R.W.P. DREVER, PROFESSOR OF PHYSICS, CALTECH (CO-PI)					\$
R. WEISS, PROFESSOR OF PHYSICS, MIT (CO-PI)					\$
FRANK SCHUTZ, PROJECT MANAGER					
PAUL LINSAY, PETER SAULSON, ROBERT SPERO, STAN WHITCOMB (CO-I)					
() OTHERS (LIST INDIVIDUALLY ON BUDGET EXPLANATION PAGE)					
(6) TOTAL SENIOR PERSONNEL (1-5)					31,250
OTHER PERSONNEL (SHOW NUMBERS IN BRACKETS)					
() POST DOCTORAL ASSOCIATES					
(5) OTHER PROFESSIONALS (TECHNICIAN, PROGRAMMER, ETC.)		25			78,333
() GRADUATE STUDENTS					
() UNDERGRADUATE STUDENTS					
(1) SECRETARIAL-CLERICAL					8,334
() OTHER					
TOTAL SALARIES AND WAGES (A+B)					117,917
FRINGE BENEFITS (IF CHARGED AS DIRECT COSTS) @ 28.5%					33,606
TOTAL SALARIES, WAGES AND FRINGE BENEFITS (A+B+C)					151,523
PERMANENT EQUIPMENT (LIST ITEM AND DOLLAR AMOUNT FOR EACH ITEM EXCEEDING \$1,000:)					
TOTAL PERMANENT EQUIPMENT					
TRAVEL 1. DOMESTIC (INCL. CANADA AND U.S. POSSESSIONS)					15,000
2. FOREIGN					3,000
PARTICIPANT SUPPORT COSTS					
1. STIPENDS \$ _____					
2. TRAVEL _____					
3. SUBSISTENCE _____					
4. OTHER _____					
TOTAL PARTICIPANT COSTS					
OTHER DIRECT COSTS					
1. MATERIALS AND SUPPLIES					3,000
2. PUBLICATION COSTS/PAGE CHARGES					11,000
3. CONSULTANT SERVICES					8,000
4. COMPUTER (ADPE) SERVICES					7,000
5. SUBCONTRACTS (SEE ATTACHMENT A)					394,000
6. OTHER JPL SUPPORT WORK ORDER					284,770
TOTAL OTHER DIRECT COSTS					707,770
TOTAL DIRECT COSTS (A THROUGH G)					877,293
INDIRECT COSTS (SPECIFY) INSTITUTE INDIRECT COST @ 53% ON ALL EXCEPT AS INDICATED ON ATTACHMENT A AND EXCEPT G.6					
TOTAL INDIRECT COSTS					122,707
TOTAL DIRECT AND INDIRECT COSTS (H + I)					1000,000
RESIDUAL FUNDS (IF FOR FURTHER SUPPORT OF CURRENT PROJECTS GPM 252 AND 253)					
AMOUNT OF THIS REQUEST (J) OR (J MINUS K)					\$1000,000
PI/PD TYPED NAME & SIGNATURE*		DATE	FOR NSF USE ONLY		
INST. REP. TYPED NAME & SIGNATURE*		DATE	INDIRECT COST RATE VERIFICATION		
			Date Checked	Date of Rate Sheet	Initials - DGC
					Program

SECOND YEAR SUMMARY
APPENDIX V 11-1-85 thru 10-31-86 **PROPOSAL BUDGET**

OMB No. 3145-0058
 Exp. Date 12/31/85

ORGANIZATION		FOR NSF USE ONLY			
		PROPOSAL NO.	DURATION (MONTHS)		
PRINCIPAL INVESTIGATOR/PROJECT DIRECTOR		AWARD NO.	Proposed	Granted	
CALIFORNIA INSTITUTE OF TECHNOLOGY					
R.W.P. DREVER, CALTECH / R. WEISS, MIT					
A. SENIOR PERSONNEL: PI/PD, Co-PI's, Faculty and Other Senior Associates (List each separately with title; A.6. show number in brackets)		NSF FUNDED PERSON-MOS		FUNDS REQUESTED BY PROPOSER	FUNDS GRANTED BY NSF (IF DIFFERENT)
		CAL.	ACAD	SUMR	
1. R.W.P. DREVER, PROFESSOR OF PHYSICS CALTECH (CO-PI)					\$
2. R. WEISS, PROFESSOR OF PHYSICS, MIT (CO-PI)					\$
3. FRANK SCHUTZ, PROJECT MANAGER					
4. PAUL LINSAY, PETER SAULSON, ROBERT SPERO, STAN WHITCOMB (CO-I)					
5. () OTHERS (LIST INDIVIDUALLY ON BUDGET EXPLANATION PAGE)					
6. (6) TOTAL SENIOR PERSONNEL (1-5)				\$ 73,562	
B. OTHER PERSONNEL (SHOW NUMBERS IN BRACKETS)					
1. () POST DOCTORAL ASSOCIATES					
2. (5) OTHER PROFESSIONALS (TECHNICIAN, PROGRAMMER, ETC.)		60		184,397	
3. () GRADUATE STUDENTS					
4. () UNDERGRADUATE STUDENTS					
5. (1) SECRETARIAL-CLERICAL				19,616	
6. () OTHER					
TOTAL SALARIES AND WAGES (A+B)				277,575	
C. FRINGE BENEFITS (IF CHARGED AS DIRECT COSTS) @28.5%				79,110	
TOTAL SALARIES, WAGES AND FRINGE BENEFITS (A+B+C)				356,685	
D. PERMANENT EQUIPMENT (LIST ITEM AND DOLLAR AMOUNT FOR EACH ITEM EXCEEDING \$1,000:)					
TOTAL PERMANENT EQUIPMENT					
E. TRAVEL 1. DOMESTIC (INCL. CANADA AND U.S. POSSESSIONS)				33,245	
2. FOREIGN				6,235	
F. PARTICIPANT SUPPORT COSTS					
1. STIPENDS \$ _____					
2. TRAVEL _____					
3. SUBSISTENCE _____					
4. OTHER _____					
TOTAL PARTICIPANT COSTS					
G. OTHER DIRECT COSTS					
1. MATERIALS AND SUPPLIES				6,420	
2. PUBLICATION COSTS/PAGE CHARGES				29,425	
3. CONSULTANT SERVICES				10,700	
4. COMPUTER (ADPE) SERVICES				16,050	
5. SUBCONTRACTS (SEE ATTACHMENT A)				3723,240	
6. OTHER (IPI, SUPPORT WORK ORDER/CONTINGENCY)				1159,720	
TOTAL OTHER DIRECT COSTS				4945,555	
H. TOTAL DIRECT COSTS (A THROUGH G)				5341,720	
I. INDIRECT COSTS (SPECIFY)					
INSTITUTE INDIRECT COST @ 53% ON ALL EXCEPT AS					
TOTAL INDIRECT COSTS INDICATED ON ATTACHMENT A AND EXCEPT G.6				358,280	
J. TOTAL DIRECT AND INDIRECT COSTS (H + I)				5700,000	
K. RESIDUAL FUNDS (IF FOR FURTHER SUPPORT OF CURRENT PROJECTS GPM 252 AND 253)					
L. AMOUNT OF THIS REQUEST (J) OR (J MINUS K)				\$ 5700,000	\$
PI/PD TYPED NAME & SIGNATURE*		DATE	FOR NSF USE ONLY		
INST. REP. TYPED NAME & SIGNATURE*		DATE	Date Checked	Date of Rate Sheet	Initials - DGC

COST ESTIMATE PREPARED IN NSF FORMAT--ATTACHMENT A

	1985	1986	
AMOUNT OF REQUEST	\$1,000,000	\$5,700,000	\$6,700,000
SUBCONTRACTOR	1985	1986	TOTAL
ENGINEERING DESIGN*	\$386,000	\$814,000	\$1,200,000
MISCELLANEOUS*	8,000	34,240	42,240
PROTOTYPE TESTING			
SCIENCE SUPPORT BY CALTECH		\$100,000	\$100,000
SCIENCE SUPPORT BY MIT*		100,000	100,000
PIPE EVALUATION BY MIT		105,000	105,000
DELAY LINE MIRROR DEVELOPMENT*		130,000	130,000
FABRY-PEROT MIRROR DEVELOPMENT*		340,000	340,000
BELLOWS EVALUATION BY MIT		40,000	40,000
ION PUMP TESTING BY MIT		72,000	72,000
VALVE TESTING BY MIT		140,000	140,000
LASER DEVELOPMENT CONTRACT*		375,000	375,000
HIGH POWER OPTICAL TEST BED*		350,000	350,000
VACUUM TEST BED AT CALTECH		500,000	500,000
PROTOTYPE VACUUM SYSTEM AT MIT		423,000	423,000
INDEPENDENT COST ESTIMATE*		200,000	200,000
TOTAL	\$394,000	\$3,723,240	\$4,117,240

*ELEMENTS WHICH ARE INDIRECT COST BEARING

REFERENCES

1. G.E. Moss, LR Miller, and RL Forward, *Appl. Optics*, 10, 2495 (1971);
R. Weiss, Prog. Report 105, Res. Lab Electronics, MIT, 54 (1972).
2. R. Weiss, in *Sources of Gravitational Radiation*, ed. L. Smarr (Cambridge U. Press, 1979), p.7.
3. R.W.P. Drever, in *Gravitational Radiation*, eds. N. Derouelle and T. Piran (North Holland, 1983), p.321.
4. C.M. Caves, *Phys. Rev. D* 23, 1693 (1981).
5. W.M. Unruh, private communication. Unruh's idea has been confirmed in as-yet-unpublished calculations by C.M. Caves.
6. K.S. Thorne, C.M. Caves, V.D. Sandberg, M. Zimmermann, and R.W.P. Drever, in *Sources of Gravitational Radiation*, ed. L. Smarr (Cambridge U. Press, 1979), p.49.
7. P.C. Peters and J. Mathews, *Phys. Rev.* 131, 435 (1963).
8. J.P.A. Clark and D.M. Eardley, *Astrophys. J.* 215, 311 (1977); Y. Kojima and T. Nakamura, *Prog. Theor. Phys.* 71, 79 (1984).
9. D.M. Eardley, in *Gravitational Radiation*, ed. N. Dereulle and T. Piran (North Holland, 1983), p. 257.
10. R.A. Saenz and S.L. Shapiro, *Astrophys. J.* 244, 1033 (1981); C. Evans, L. Smarr, and J. Wilson, unpublished results reported at Santa Barbara Workshop on Gravitational Radiation, March, 1984.
11. M. Zimmermann and E. Szedenits, Jr. , *Phys. Rev. D* 20, 351 (1979);
M. Zimmermann, *Phys. Rev. D* 21, 891 (1980).
12. J. Friedman and B. Schutz, *Astrophys. J.* 222, 281 (1978).
13. R.V. Wagoner, *Astrophys. J.* 278, 345 (1984).
14. M. Rees, in *Gravitational Radiation*, ed. N. Derculle and T. Piran (North Holland, 1983), p.297;

- J.R. Bond and B.J. Carr, Mon. Not. Roy. Astron. Soc. 207, 585 (1984).
15. Ya.B. Zel'dorovich and I.D. Novikov, *The Structure and Evolution of the Universe* (U. Chicago Press, 1983), pp. 160-163.
 16. L.P. Grishchuk, Sov. Phys. - JETP 40, 409 (1975).
 17. G.W. Gibbons, S.W. Hawking, and S.T.C. Siklos, editors, "*The Very Early Universe*" (Cambridge University Press, 1983); A. Starobinsky, JETP Lett. 30, 686 (1979);
A. Vilenkin, Phys. Rev. D 24, 2082 (1981); C.J. Hogan and M.J. Rees, Nature, in press.
 18. J.P.A. Clark, E.P.J. van den Heuvel, and W. Sutantyo, Astron. Astrophys. 72, 120 (1979).
 19. J.H. Taylor, unpublished lecture at Santa Barbara Workshop on Gravitational Radiation, March, 1984.
 20. M. Ali Alpar and D. Pines, Preprint P/84/7/101 of Dept. of Physics, University of Illinois (1984).
 21. T. Piran, in *Gravitational Radiation*, eds. N. Dereulle and T. Piran (North Holland, 1983), p. 203;
L. Smarr, Ann. N.Y. Acad. Sci. 302, 569 (1977).
 22. R. Weiss, "*Interferometric Broad Band Gravitational Antenna*", proposal to NSF accompanying this proposal; also D. Dewey, Bull. Amer. Astron. Soc. 16, 517 (1984).
 23. R.W.P. Drever, J.L. Hall, F.V. Kowalski, J.R. Hough, G.M. Ford, A.J. Munley, and H. Ward, Appl. Phys. B 31, (1983), 97;
Drever, R.W.P., Hough, J., Munley, A.J., Lee, S.-A., Spero, R., Whitcomb, S.E., Ward, H., Ford, G.M., Hereld, M., Robertson, N.A., Kerr, I., Pugh, J., Newton, G.P., Meers, B., Brooks, E.D., and Gursel, Y. in *Laser Spectroscopy V*, ed. by A.R.W. McKellar, T. Oka, and B.P. Stoicheff (Springer, New York 1981) p. 33;
Drever, R.W.P., Hough, J., Munley, A.J., Lee, S.-A., Spero, R., Whitcomb, S.E., Pugh, J., Newton, G., Meers, B., Brooks III, E., and Gursel, Y. in *Quantum Optics, Experimental Gravity, and Measurement Theory* (eds. P. Meystere and M.O. Scully), (Plenum Publishing, 1983), 503;

- Hough, J., Drever, R.W.P., Munley, A.J., Lee, S.-A., Spero, R., Whitcomb, S.E., Pugh, J., Newton, G., Meers, B., Brooks III, E., and Gursel, Y. in *Quantum Optics, Experimental Gravity, and Measurement Theory* (eds. P. Meystere and M.O. Scully), 515, (Plenum Publishing, 1983).
24. Whitcomb, S.E., Anderson, D.Z., Drever, R.W.P., Gursel, Y., Hereld, M., and Spero, R., Proc. of 3rd Marcel Grossmann Conference on General Relativity, 1982, ed. Hu Ning (Science Press and North-Holland Publishing Co., 1983) p. ;
- R.W.P. Drever, S. Hoggan, J. Hough, B.J. Meers, A.J. Munley, G.P. Newton, H. Ward, D.Z. Anderson, Y. Gursel, M. Hereld, R. Spero, and S.E. Whitcomb; Proc. of 3rd Marcel Grossmann Conference on General Relativity, 1982, ed. Hu Ning (Science Press and North-Holland Publishing Co., 1983) p. 739.
25. Drever, R.W.P., Hough, J., Bland, R., and Lessnoff, G.W., *Nature* 246, (1973), 340; Drever, R.W.P., Hough, J., Bland, R., and Lessnoff, G.W., *Colloques Internationaux du Centre National de la Recherche Scientifique (Ondes et Radiations Gravitationelles, 1973)*: CNRS Report 220, (Paris, 1974), (ed. Y. Choquet-Bruhat), 113.
26. Hough, J., Pugh, J.R., Bland, R., and Drever, R.W.P. *Nature* 254, (1975), 498.
27. R.W.P. Drever, J. Hough, W.A. Edelstein, J.R. Pugh, and W. Martin, in *Gravitatione Sperimentale* (Accademia Nazionale dei Lincei, Rome, 1977); B. Bertotti, Ed. p. 365.
28. R.W.P. Drever, G.M. Ford, J. Hough, I.M. Kerr, A.J. Munley, J.R. Pugh, N.A. Robertson, and H. Ward, in *Proceedings of the 9th International Conference on General Relativity and Gravitation* (Jena 1980), ed. E. Schmutzer (VEB Deutscher Verlag der Wissenschaften, Berlin, 1983), p. 265.
29. J. Hough, G.P. Newton, N.A. Robertson, H. Ward, B.J. Meers, S. Hoggan, G.A. Kerr and J.B. Mangan. *Conf. on Precision Electromagnetic Measurement*, Netherlands, 1984. (to be published).
30. H. Billing, W. Winkler, R. Schilling, A. Rudiger, K. Maischberger, and L. Schnupp, in *Quantum Optics; Experimental Gravity and Measurement Theory*, Ed. P. Meystre and M.O. Scully, Plenum Pub., p. 525 (1983), p.
31. R. Schilling, L. Schnupp, D.H. Shoemaker, W. Winkler, K. Maischberger, and A. Rudiger. Proc. Journees Relativistes (May 1984 meeting in Aussois, France), in press.

32. C.N. Man and A. Brillat, *Optics Letters*, Vol.9, No 8 (August 1984).
33. Research Reports, A. Ioffe Physico-Technical Institute 1976 pp. 1 and 65; 1978 pp. 3 and 29.
34. The restructuring of the project and its plans were described at a meeting of the Division of General Physics and Astronomy of the Soviet Academy of Sciences in Moscow on March 26, 1979; but only the title of the presentation, not an abstract, was published in the proceedings of the meeting. [Sov. Phys - Uspekhi, 23, 704 (1980).]
35. Some of Chebotayev's gravity wave detection ideas have been published by S.N. Bagayev, V.P. Chebotayev, A.S. Dychkov, and V.G. Goldort, *Appl. Phys.* 25, 161 (1981).
36. N.A. Robertson, R.W.P. Drever, I. Kerr, and J. Hough, *J. Phys. E: Sci. Instrum.*, Vol.15, (1982)
37. J.E. Faller and R.L. Rinker *Dimensions*, p. 25 (September 1979).
38. P. Linsay, P. Saulson, and R. Weiss, *A Study of a Long Baseline Gravitational Wave Antenna System*, report prepared for the National Science Foundation under grant PHY-8109581 to the Massachusetts Institute of Technology (MIT, October 1983). Copies can be obtained by writing to R. Weiss at MIT.

VITAE AND PUBLICATIONS OF SENIOR PERSONNEL

CURRICULUM VITAE
RONALD WILLIAM PREST DREVER

Department of Physics 130-33
California Institute of Technology
Pasadena, CA. 91125
(818)356-4291

PERSONAL

Born in Renfrewshire, Scotland, October 26, 1931

Nationality: British

DEGREES

B.Sc. in Pure Science (First Class Honours, Natural Philosophy),

Glasgow University 1953

Ph.D., Glasgow University 1958

CURRENT APPOINTMENTS

Professor of Physics, California Institute of Technology,

-1/2 time 1979-1984

full time 1984

PREVIOUS APPOINTMENTS

Research Fellow, Glasgow University 1956-1960

Lecturer, Glasgow University 1960-1967

Research Fellow, Harvard University, USA 1960-1961

(on leave of absence from Glasgow University)

Senior Lecturer, Glasgow University 1967-1973

Reader, Glasgow University 1973-1975

Titular Professor, Glasgow University 1975-1979

-1/2 time 1979-1984

Visiting Associate, California Institute of Technology 10/77-1/78

CONSULTING & LECTURING APPOINTMENTS

Consultant and Vacation Assistant, Atomic Energy Research Establishment, Harwell (UK Atomic Energy Authority)	1968 -
Consultant, National Science Foundation (USA)	1974 -
Morris Loeb Lectureship in Physics, Harvard University	1979

OFFICIAL POSITIONS

Member of the Astronomy Policy and Grants Committee, (UK) Science Research Council	1972-1974
Royal Astronomical Society Assessor to the Astronomy I Committee, (UK) Science Research Council (Policy and Grants in Radio, X-ray, and Gamma-Ray Astronomy, etc.)	1974-1976
Council Member of the Royal Astronomical Society	1972-1976
Vice President of the Royal Astronomical Society	1973-1976

PROFESSIONAL SOCIETIES

Associate Member of the Institute of Physics (UK)
Fellow of the Royal Astronomical Society (UK)
Fellow of the Royal Astronomical Society of Edinburgh
Member of the American Physical Society

R.W.P. Drever

Publications

1. K-capture in the decay of Chlorine-36. Drever, R.W.P. and Moljk, A. *Phil. Mag.* 46, (7th S.), 1336 (1955)
2. Neutron activation applied to Potassium-mineral dating. Moljk, A., Drever, R.W.P., and Curran, S.C. *Rev. Sci. Inst.* 26, 1034 (1955)
3. Measurement of Tritium as water vapour. Drever, R.W.P. and Moljk, A. *Rev. Sci. Inst.* 27, 650 (1956)
4. Ratio of K-capture to positron emission in Flourine-18. Drever, R.W.P., Moljk, A., and Curran, S.C. *Nucl. Inst. and Meth.* 1, 41 (1957)
5. L/K capture ratio of Germanium-71. Drever, R.W.P. and Moljk, A. *Phil. Mag.* 2, (8th S.), 427 (1957)
6. Proportional counters for demonstration experiments. Moljk, A. and Drever, R.W.P., *Amer. J. Phys.* 25, 165 (1957).
7. The background of counters and radiocarbon dating. Moljk, A., Drever, R.W.P., and Curran, S.C. *Proc. Roy. Soc.* A239, 433 (1957)
8. Studies of orbital electron capture using proportional counters. Drever, R.W.P., Ph.D. Thesis, University of Glasgow, (1958)
9. Proportional counters for low activity measurements. Moljk, A., Drever, R.W.P., and Curran, S.C. "*Radioisotopes in Scientific Research*," Vol. II, 596 (Proc. first UNESCO Int. Conf., Paris, 1957), (Pergamon Press, 1958)
10. Upper limit to anisotropy of inertial mass. Drever, R.W.P. *Phil. Mag.* 5, (8th S.), 409 (1960)
11. A search for anisotropy of inertial mass using a free precession technique. Drever, R.W.P. *Phil. Mag.* 6, (8th S.), 683 (1961)

Note

Material omitted from the above list includes U.K. Atomic Energy Authority Reports, of which a number deal with astronomical work done at or in collaboration with the Atomic Energy Research Establishment, Harwell (mostly published subsequently elsewhere); and numerous papers presented orally at conferences on various subjects.

Some of the papers listed above involved collaboration between groups in up to five countries, in wide-spaced coincidence experiments. In these cases the locations of the laboratories are indicated as well as the names of the people taking part in each institution.

12. Effect of hydrostatic compression on the 14.4 keV gamma ray from Iron-57. Pound, R.V., Benedek, G.B., and Drever, R.W.P. *Phys. Rev. Lett.* 7, 405 (1961)
13. The L/K capture ratio of Argon-37. Dougan, P.W., Ledingham, K.W.D., and Drever, R.W.P. *Phil. Mag.* 7, (8th S.), 475 (1962)
14. The decay of Chlorine-36 to Sulphur-36. Dougan, P.W., Ledingham, K.W.D., and Drever, R.W.P., *Phil. Mag.* 7, (8th S.), 1223 (1962)
15. The ratio of K-capture to positron emission in the decay of Nitrogen-13. Ledingham, K.W.D., Payne, J.A., and Drever, R.W.P., *Proc. Int. Conf. on Role of Atomic Electrons in Nuclear Transformations, Warsaw, 1963, Vol. II*, 359 (ed. D. Berenyi) (1956)
16. Search for high energy gamma-rays from pulsar CP 1133. Charman, W.N., Jelley, J.V., Orman, P.R., Drever, R.W.P., and McBreen, B. *Nature*, 220, 565 (1968).
17. A technique for removing pile-up distortion in high precision pulse height spectroscopy. Drever, R.W.P. and Williams, M.D.C. *Proc. Int. Symposium on Nuclear Electronics, Versailles, 1968.*
18. Further search for high energy gamma-rays from CP 1133. Charman, W.N. and Drever, R.W.P. *Nature* 224, 567 (1969)
19. A search for periodic high energy gamma rays from pulsars. Charman, W.N., Jelley, J.V., and Drever, R.W.P., *Proc. 11th Int. Conf. on Cosmic Rays, Budapest, 1969; Act Phys. Acad. Sci. Hungar.* 29, Suppl. 1, 63 (1970)
20. The ratio of K-capture to positron emission in the decay of Carbon-11. Campbell, J.L., Leiper, W., Ledingham, K.W.D., and Drever, R.W.P. *Nucl. Phys.* A96, 279 (1967)
21. Upper-air fluorescence as a tool in X-ray astronomy and searches for X-rays from CP 0532 and other pulsars. Charman, W.N., Drever, R.W.P., Fruin, J.H., and Jelley, J.V. in *Non solar X- and gamma-ray astronomy*, (ed. L. Gratton), (Int. Astron. Union, 1970)
22. Spaced receiver observations of radio pulses. Charman, W.N., Jelley, J.V., Fruin, J.H. (Atomic Energy Research Establishment, Harwell); Hodgson, E.R., Scott, P.F., Shakeshaft, J.R. (Mullard Radio Astronomy Observatory, University of Cambridge); Baird, G.A., Delaney, T., Lawless, B.G. (University College, Dublin); Drever, R.W.P., Meikle, W.P.S. (University of Glasgow); Porter, R.A. and Spencer, R.E. (Nuffield Radio Astronomy Laboratories, Jodrell Bank,

- University of Manchester), *Nature*, 228, 346 (1970)
23. A search for isolated radio pulses from the Galactic Centre at 151.5 MHz. Charman, W.N., Fruin, J.H., Jelley, J.V. (Harwell); Haynes, R.F., Hodgson, E.R., Scott., P.F., Shakeshaft, J.R. (Cambridge); Baird, G.A., Delaney, T., Lawless, B.F. (Dublin and Malta); Drever, R.W.P., and Meikle, W.P.S. (Glasgow) *Nature* 232, 177 (1971)
 24. A precision sidereal telescope drive. Drever, R.W.P., Fruin, J.H., and Jelley, J.V. *Observatory* 91, 203 (1971)
 25. K-electron capture to positron emission ratio in the decays of Oxygen-15 and Neon-19. Leiper, W. and Drever, R.W.P., *Phys. Rev.* C6, 1132 (1972)
 26. A search for isolated radio pulses from the Crab Nebula at 151.5 MHz. Meikle, W.P.S., Drever, R.W.P. (Glasgow); Haynes, R.F., Shakeshaft, J.R. (Cambridge); Charman, W.N., and Jelley, J.V. (Harwell) *Mon. Not. Astro. Soc.* 160, 50 (1972)
 27. Proportional counters for the localisation of ionising radiation. Hough, J. and Drever, R.W.P. *Nucl. Instr. and Meth.* 103, 365 (1972)
 28. Contribution to open discussion on gravitational radiation experiments. Drever, R.W.P. *Proc. Sixth Texas Symp. on Relativistic Astrophysics*, (ed. J.H. Hegyi), *Ann. New York Acad. Sci.* 224, 103 (1973)
 29. Weber's Waves. Drever, R.W.P., *Nature* 243, 553 (1973)
 30. Search for short bursts of gravitational radiation. Drever, R.W.P., Hough, J., Bland, R., and Lessnoff, G.W., *Nature* 246, 340 (1973)
 31. An experiment to search for prompt emissions from supernovae at microwave frequencies. Jelley, J.V. (Harwell); Meikle, W.P.S., Drever, R.W.P. (Glasgow); Palumbo, G.G.C., Bonoli, F. (Bologna); Smith, H. and Delaney, T. (Dublin). *Proc. Int. Conf. on Supernovae and Supernovae Remnants, Lecce, May, 1973*, (ed. C.G. Cosmovici), 61, (D. Reidel Publishing Co., 1974).
 32. Experiments and observations with wide band gravity wave detectors. Drever, R.W.P., Hough, J., Bland, R., and Lessnoff, G.W., *Colloques Internationaux du Centre National de la Recherche Scientifique (Ondes et Radiations Gravitationelles, June, 1973)*: CNRS Report 220, 113 (Paris, 1974), (ed. Y. Choquet-Bruhat)

33. Gravitational wave experiments. Drever, R.W.P. Proc. 1973 School for Young High Energy Physicists, Rutherford Laboratory (ed. H. Muirhead). Rutherford Lab. Report RL-74-038, VIII-1 (1974)
34. Searches for ionospheric effects of X-ray bursts, and for bursts of radio emission, gravitational radiation and microwave emission from astronomical sources. Drever, R.W.P., Meikle, W.P.S., Hough, J., Bland, R., and Lessnoff, G.W. (Glasgow); in association with Jelley, J.V. (Harwell); Delaney, T. (Dublin); and Palumbo, G.G.C. (Bologna). Proc. Conf. on Transient Cosmic Gamma and X-ray Sources, Los Alamos, September, 1978, (ed. I. Strong), LA-5505-C Conference Proceedings UC-34B (1974)
35. A search for isolated microwave pulses from the Perseus Clusters of Galaxies. Delaney, T., Baird, G.A., Smith, H. (Dublin); Jelley, J.V., Fruin, J.H. (Harwell); Meikle, W.P.S., Drever, R.W.P. (Glasgow); Morigi, G., Palumbo, G.G.C. (Bologna); and Partridge, R.G. (Haverford, USA), *Astron. and Astrophys.* 36, 83 (1974)
36. Contribution to panel discussion on gravitational waves. Drever, R.W.P. Proc. Seventh Int. Conf. on Gen. Relativity and Gravitation, Tel-Aviv, June 1974 (ed. G. Shaviv and J. Rosen; Halsted Press- John Wiley), 243-298, (1975)
37. A search for VHF radio pulses in coincidence with celestial gamma-ray bursts. Baird, G.A., Delaney, T., Lawless, B.F. (Dublin); Griffiths, D.J., Shakeshaft, J.R. (Cambridge); Drever, R.W.P., Meikle, W.P.S. (Glasgow); Jelley, J.V. and Charman, W.N. (Harwell), *Astrophys. J. Lett.* 196, L11 (1975)
38. Search for continuous gravitational radiation. Hough, J., Pugh, J.R., Bland, R. and Drever, R.W.P. *Nature* 254, 498 (1975)
39. An upper limit to microwave pulse emission at the onset of a supernova. Meikle, W.P.S., Drever, R.W.P. (Glasgow); Baird, G.A., Delaney, T. (Dublin); Jelley, J.V., Fruin, J.H. (Harwell); Palumbo, G.G.C., Morigi, G. (Bologna); and Partridge, R.B. (Haverford, USA), *Astron. and Astrophys.* 46, 477 (1976)
40. Gravitational-Wave Astronomy. Drever, R.W.P., *Quarterly J. Roy. Astr. Soc.* 18, 9 (1977)
41. Gravitational wave detectors using optical interferometry. Drever, R.W.P., Hough, J., Edelstein, W., and Martin, W. *Gravitazione Sperimentale*, (ed. B. Bertotti), (Accademia Nazionale dei Lincei, Rome, 1977) pp.365.

42. Upper limits for the microwave pulsed emission from supernova explosions in clusters of galaxies. Palumbo, G.G.C., Mandolesi, N., Morigi, G. (Bologna); Baird, G.A., Delaney, T. (Dulin); Meikle, W.P.S., Drever, R.W.P. (Glasgow); Jelley, J.V., Fruin, J.H. (Harwell); and Partridge, B. (Haverford USA), *Astrophys. Space Sci.*, 54, 355 (1978)
43. Gravity wave detection: a tough challenge. Hough, J. and Drever, R.W.P., *New Scientist*, 79, 464 (1978)
44. Quantum nondemolition measurements of harmonic oscillators. Thorne, K.S., Drever, R.W.P., Caves, C.M., Zimmermann, M. and Sandberg, V.D. *Phys. Rev. Lett.*, 40, 667 (1978)
45. The quantum limit for gravitational wave detectors and methods of circumventing it. Thorne, K.W., Caves, C.M., Sandberg, V.D., Zimmermann, M., and Drever, R.W.P. "*Sources of Gravitational Radiation*," (ed. L. Smarr), (Cambridge University Press, 1979) pp.49.
46. On the measurement of a weak classical force coupled to a quantum mechanical oscillator. Caves, C.M., Drever, R.W.P., Sandberg, V.D., Thorne, K. S., and Zimmermann, M. *Rev.Mod. Phys.*, 52, (2), 341, (1980).
47. Optical cavity laser interferometers for gravitational wave detection. Drever, R.W.P., Hough, J., Munley, A.J., Lee, S.-A., Spero, R., Whitcomb, S.E., Ward, H., Ford, G.M., Hereld, M., Robertson, N.A., Kerr, I., Pugh, I., Newton, G.P., Meers, B., Brooks, E.D. Gursel, Y. *Proceedings of the Fifth International Conference on Laser Spectroscopy (VICOLS)*, Jasper, Canada, 33, (Springer-Verlag, 1981).
48. Interferometric detectors for gravitational radiation. Drever, R.W.P., "*Gravitational Radiation*," NATO Advanced Physics Institute, Les Houches, (ed. N. Deruelle and T. Piran), 321-337, (North Holland Publishing, 1983)
49. ~~Laser interferometer gravitational radiation detectors. Drever, R.W.P., "*Science Underground*," American Institute of Physics, Conference Proceedings No. 96, 336-346, (Los Alamos, 1982)~~
50. Passive and active isolation for gravitational radiation detectors and other instruments. Robertson, N.A., Drever, R.W.P., Kerr, I., Hough, J., *Phys. E. Sci. Instr.*, 15, 1101-1105, 1982.

51. The search for gravitational waves. Drever, R.W.P., "*Engineering and Science*," 6-9; 24-26; (Caltech, 1983)
52. Gravitational wave detectors using laser interferometers and optical cavities: 1. Ideas, Principles, and Prospects. Drever, R.W.P., Hough, J., Munley, A.J., Lee, S.-A., Spero, R., Whitcomb, S.E., Pugh, J., Newton, G., Meers, B., Brooks III, E., Gursel, Y. in "*Quantum Optics, Experimental Gravity, and Measurement Theory*" (eds. Pierre Meystere and Marlan O. Scully), 503-514, (Plenum Publishing, 1983)
53. Contribution on the millisecond pulsar. Drever, R.W.P. Proceedings of the Meeting of the Royal Astronomical Society, December, 1982, The Observatory, 103, 118, June, (1983)
54. Laser phase and frequency stabilization using an optical resonator. Drever, R.W.P., Hall, J.L., Kowalski, F.V., Hough, J., Ford, G.M., Munley, A.J., Ward, H., *Applied Physics*, B 31, 97-103, (1983)
55. A gravity wave detector using optical cavity sensing. Drever, R.W.P., Ford, G., Hough, J., Kerr, I., Munley, A., Pugh, J., Robertson, N. and Ward, H., Proceedings of the 9th International Conference on General Relativity and Gravitation, 1981, (ed. E. Schmutzer), 265-267, (Veb Deutscher Verlag der Wissenschaften, DDR-1080, Berlin, 1983)
56. Direct observational upper limit to gravitational radiation from millisecond pulsar PSR 1937 + 214. Hough, J., Drever, R.W.P., Ward, H., Munley, A.J., Newton, G., Meers, B., Hoggan, S., Kerr, G.A., *Nature*, 303, (5941), 216-7, (May, 1983)
57. Laser interferometer experiments at Caltech. Whitcomb, S.E., Anderson, D.Z., Drever, R.W.P., Gursel, Y., Hereld, M., Spero, R., Third Marcel Grossman Conference on General Relativity, Shanghai, China 1982, Ed. Hu Ning (Science Press and North-Holland Publishing Co., 1983) pp. 1399
58. Developments in laser interferometer gravitational wave detectors. Drever R.W.P., Hoggan, S., Hough, J., Meers, B.J., Munley, A.J., Newton, G.P., Ward, H., Anderson, D.Z., Gursel, Y. Hereld, M., Spero, R., Whitcomb, S.E., Third Marcel Grossman Conference on General Relativity, Shanghai, China 1982, Ed. Hu Ning (Science Press and North-Holland Publishing Co., 1983) pp. 739-753

59. The Caltech Gravitational Wave Detector. R. Spero, D.Z. Anderson, R.W.P. Drever, Y. Gursel, G. Gutt, M. Hereld, J. Kaufman, S.E. Whitcomb; in "*General Relativity and Gravitation*", 10th International Conf. on General Relativity and Gravitation, Padua, July 1983. eds. B. Bertotti, F. de Felice, and A. Pascolini; (Reidel Pub. Co. 1984).
60. R.W.P. Drever. "*Laser Interferometer Gravitational Wave Detectors*" in "*General Relativity and Gravitation*", 10th International Conf. on General Relativity and Gravitation, Padua, July 1983. eds. B. Bertotti, F. de Felice, and A. Pascolini; (Reidel Pub. Co. 1984) pp. 397-412.

RAINER WEISS

Date of Birth: September 29, 1932

Title: Professor of Physics

Place of Birth: Berlin, Germany

Citizenship: USA

Education

Massachusetts Institute of Technology B.S. 1955

Massachusetts Institute of Technology Ph.D. 1962

Professional Experience

1973 - Present Professor of Physics, M.I.T.

1967 - 1973 Associate Professor of Physics, M.I.T.

1964 - 1967 Assistant Professor of Physics, M.I.T.

1962 - 1964 Research Associate in Physics, Princeton University

1961 - 1962 Assistant Professor of Physics, Tufts University

1960 - 1961 Instructor of Physics, Tufts University

Public Service

Member, NASA Physical Science Committee, 1970 - 1974

Member, National Academy Summer Study on Outer Planet Exploration, 1972

Member, NASA Shuttle Working Group, 1973 - 1976

Member, NASA Infrared Working Group, 1973 -

Chairman, NASA Panel on Experimental Relativity and Gravitation, 1974 - 1976

Member, NCAR, Scientific Ballooning Advisory Panel, 1971 - 1978

Chairman, NCAR Scientific Ballooning Advisory Panel, 1974 - 1978

Members' Representative to NCAR from M.I.T., 1974 - 1982

Chairman, NSF Subcommittee on Gravitational Physics, 1978

Rainer Weiss
Public Service (continued)

Member, NASA SSSC Committee, 1979 - 1982

Member, NASA Infrared Detector Panel, 1978

Member, NASA Space and Earth Science Advisory Committee, 1982

Member, National Academy Space Science Board, 1983 -

Panel Chairman, National Academy Summer Study on Use of the Space Platform, 1984

Publications by Rainer Weiss

1. "Magnetic Moments and Hyperfine Structure Anomalies of Cs¹³³, Cs¹³⁵, and Cs¹³⁷," Phys. Rev. 105, 590 (1957), with H.H. Stroke, V. Jaccarino, and D.S. Edmonds.
2. "Molecular Beam Electron Bombardment Detector," Rev. Sci. Instr. 32, 397 (1961).
3. "A Search for a Frequency Shift of 14.4 KeV Photons on Traversing Radiation Fields," Physics Letters 1, 342 (1962), with L. Grodzins.
4. "Stark Effect and Hyperfine Structure of Hydrogen Fluoride," Phys. Rev. 131, 659 (1963).
5. "The Cesium Fountain Experiment: The Paucity of Slow Atoms," Festschrift, (1965), for J.R. Zacharias.
6. "A Gravimeter to Monitor the $0S_0$ Dilational Mode of the Earth," J. Geophys. Res. 70, 5615 (1966), with B. Block.
7. "Experimental Test of the Freundlich Red-Shift Hypothesis," Phys. Rev. 155, 1412 (1967), with G. Blum.
8. "Electric and Magnetic Field Probes," A. J. Phys. 35, 1047 (1967).
9. "Laser-Induced Fluorescence in a Molecular Beam of Iodine," Phys. Rev. Lett. 20, 91 (1968), with S. Ezekiel.
10. "A Measurement of the Isotropic Background Radiation in the Far Infrared," Phys. Rev. Lett. 24, 742 (1970), with D. Muehler.
11. "Electromagnetically Coupled Broadband Gravitational Antenna," Quarterly Progress Report, Research Lab. of Electronics, M.I.T., 105, 54 (1972).
12. "Balloon Measurements of the Far Infrared Background Radiation," Phys. Rev. D 7, 326 (1973), with D. Muehler.

Rainer Weiss
Publications (continued)

13. "Further Measurements of the Submillimeter Background at Balloon Altitude," Phys. Rev. Let. 30, 757 (1973), with D. Muehler.
14. "Measurements of the Phase Fluctuations in a He-Ne Zeeman Laser," Rev. Sci. Inst. 45, 1060 (1974), with D.K. Owens.
15. "The Oldest Fossil" Technology Review 78, P 56 (1975).
16. "A Large Beam Sky Survey at Millimeter and Submillimeter Wavelengths made from Balloon Altitudes" Astrophysical Journal 231, 702 (1979) with D.K. Owens and D.J. Muehler.
17. "Gravitational Radiation - The Status of the Experiments and Prospects for the Future" in Sources of Gravitational Radiation, Cambridge University Press, Cambridge, England (1979).
18. "Monolithic Silicon Bolometers" Journal of Infrared and Millimeter Waves 1 (1980), with P.M. Downey, F.J. Bachner, J.P. Donnelly, W.T. Lindley, R.W. Mountain and D.J. Silversmith.
- 18a. "Monolithic Silicon Bolometers" Applied Optics 23, 910 (1983), with P.M. Downey, A.D. Jeffries, S.S. Meyer, F.J. Bachner, J.P. Donnelly, W.T. Lindley, R.W. Mountain, D.J. Silversmith.
19. "Measurements of the Cosmic Background Radiation" Annual Review of Astronomy and Astrophysics 18, 489 (1980).
20. "The COBE Project" Physica Scripta 21, 670 (1980).
21. "A Search for the Sunyaev-Zel'dovich Effect at Millimeter Wavelengths" Ap. J. Let. 271 L1 (1983), with S.S. Meyer, A.D. Jeffries.

Reports

"Study Report for the Cosmic Background Explorer" Goddard Space Flight Center, Feb. 1977. with S. Guzik, M Hauser, J. Mather, G. Smoot, D. Wilkinson.

"Report of the Sub-Panel on Relativity and Gravitation", Management and Operations Working Group for Shuttle Astronomy, NASA Headquarters, Sept., 1976. with P. Bender, C. Misner, R.V. Pound.

"Report of the Detector Study Panel NASA" with P. Richards (Chairman) 1979.

"A Study of a Long Baseline Gravitational Wave Antenna System" with P. Lindsay, P. Saulson 1983.

Articles in Preparation

"A Measurement of the Large Scale Angular Distribution of the Background Radiation at Millimeter and Sub-Millimeter Wavelengths," with D.J. Muehler, S.S. Meyer, M. Halpern, R. Benford.

"Noise Due to Scattered Light in Interferometric Gravitational Antennas and Its Reduction by Random Phase Modulation of the Input Beam," with D. Dewey, J. Livas.

"Analysis of a Multipass Interferometer Using Tagged Light Beams and a Compact Geometry for Gravitational Wave Research."

"Response of a Free Mass Interferometric Antenna to Gravitational Wave Excitation," with Y. Gursel, P. Linsay, R. Spero, P. Saulson and S. Whitcomb.

Resume

PAUL S. LINSAY

August 13, 1947

Principal Research Scientist
Massachusetts Institute of Technology
Department of Physics, 20F-001
Cambridge, Massachusetts 02139
617-253-4824

EMPLOYMENT:

- 79- Research Scientist, M.I.T.
- 76- Research Fellow in Physics, California Institute of
- 379 Technology

EDUCATION:

- 76 Ph.D., Physics, The University of Chicago
- 70 M.S., Physics, The University of Chicago
- 69 B.S., Mathematics, M.I.T.

GRANTS:

- 84- Office of Naval Research: Studies in Nonlinear Dynamics;
\$65,000.
- 82- Alfred P. Sloan Fund for Basic Research: Studies in nonlinear
dynamics; \$15,000.
- 83- National Science Foundation: Broadband Interferometric
984 Laser Gravity Antenna; \$500,000.
Co-investigator. Prof. Rainer Weiss, M.I.T., principal
investigator.

INVITED TALK:

Dynamics Days, January 1982, La Jolla, California

Publications:

NONLINEAR DYNAMICS:

The Self-replicating Attractor of a Driven
Semi-conductor Oscillator, S.D. Brorson, D. Dewey, and
P.S. Linsay, Physical Review A28, 1201(1983)

Period Doubling and Chaotic Behavior in a Driven
Anharmonic Oscillator, P.S. Linsay, Physical Review
Letters 47, 1349(1981)

Approximate Scaling of Period Doubling Windows, P. S.
Linsay, (to be published)

GENERAL RELATIVITY, INTERFEROMETRIC GRAVITY ANTENNA:

A Low Noise RF Capacitance Bridge, P.S. Linsay, and
D.H. Shoemaker Reviews of Scientific Instruments 1014,
53(1982)

HIGH ENERGY PHYSICS:

Observation of Prompt Like-Sign Dimuon Production in
Neutrino Reactions, K. Nishikawa, D. Buchholz, B.C.
Barish, J.F. Bartlett, R. Blair, Y. Chu, J. Lee, P.S.
Linsay, J. Ludwig, R. Messner, P. Mine, F.J. Sciulli,
M. Shaevitz, E. Siskind, D. Edwards, H. Edwards, H.E.
Fisk, Y. Fukushima, G. Krafczyk, D. Nease, A. Bodek, W.
Marsh, and O. Fackler, Physical Review Letters 46,
1555(1981)

Flux Normalized Charged-Current Neutrino Cross
Sections up to Neutrino Energies of 260 Gev, B.C.
Barish, R. Blair, J. Lee, P. Lindsay, J. Ludwig, R.
Messner, F. Sciulli, M. Shaevitz, F. Bartlett, D.
Edwards, H. Edwards, E. Fisk, G. Krafczyk, Y.
Fukushima, Q. Kerns, T. Kondo, D. Nease, S. Segler, D.
Theriot, A. Bodek, W. Marsh, O. Fackler, and K.
Jenkins, Proceedings of the Neutrino '79 International
Conference, Bergen, Norway, June 18-22 1979

Density Dependence of Dimuon Rates in the CFNRR
Experiment B.C. Barish, J.F. Bartlett, Y. K. Chu, K.
Kleinknecht, J. Lee, P.S. Lindsay, J. Ludwig, R.
Messner, P. Mine, F.J. Sciulli, M. Shaevitz, E.
Siskind, D. Edwards, H. Edwards, H.E. Fisk, G.
Krafczyk, D. Nease, D. Buchholz, K. Nishikawa, A.
Bodek, W. Marsh, and O. Fackler; Proceedings of the
International Conference on Neutrino Physics and
Neutrino Astrophysics, Purdue University, April 1978

Very Large Area Scintillation Counters for Hadron
Calorimetry B.C. Barish, A. Bodek, Y.K. Chu, K.
Kleinknecht, J. Lee, P.S. Lindsay J. Ludwig, F. Sciulli,
and M. Shaevitz, IEEE Transactions in Nuclear Science,
NS-25, p. 532, talk presented at the 1977 Nuclear
Science Symposium, San Francisco, California, Oct. 1977

Measurement of the Decay rate for the Rare process

K . Shochet, M.J., P.S. Lindsay, C.
Grosso-Pilcher, H.J. Frisch, R. Devoe, J.W. Cronin, and D.R.
Moffett, Physical Review Letters 39, 59(1977)

Measurement of the Branching Ratio
Devoe, R., J.W. Cronin, H.J. Frisch, C. Grosso-Pilcher, P.
Lindsay, M.J. Shochet, and D.R. Moffett, Physical Review D16,
565(1977)

PETER R. SAULSON

OFFICE

Department of Physics
20F-001
Massachusetts Institute of Technology
Cambridge, Mass. 02139
(617) 253-4824

HOME

81 Park Street
Brookline, Mass. 02146
(617) 232-8997

Born October 30, 1954

PROFESSIONAL EXPERIENCE

October 1981 to present

Postdoctoral Research Associate
Massachusetts Institute of Technology
Department of Physics

EDUCATION

October 1981

Ph.D. in Physics
Princeton University
Thesis: "Optical and Infrared Search
for Massive Halos of Spiral Galaxies"

October 1978

M.A. in Physics
Princeton University

June 1976

A.B. magna cum laude in Physics
Harvard University

RESEARCH EXPERIENCE

Gravitational Wave Detection

Designed and built apparatus and carried out theoretical calculations as part of a project which will make detection of gravitational waves a practical possibility, through construction of interferometric detectors with strain sensitivity of 1 part in 10^{21} .

Contributions included:

* Participation in a two-year design study of a long-baseline gravitational wave antenna. Maintained liaison with Arthur D. Little, Inc. and Stone and Webster Engineering Co., who were consultants for the study. Wrote major sections of the study report (submitted to the National Science Foundation) on vibration isolation and on sources of gravitational radiation, as well as sections on the noise budget and on construction techniques.

* Design and testing of servo-controlled vibration isolation systems for the end masses of an interferometric gravitational wave antenna. Vibration isolation is the critical factor in determining the sensitivity of such antennas at frequencies below 1 kHz.

* Calculation of the strength of stochastic gravitational forces due to disturbances in the environment of a gravitational wave antenna. The spectrum of this noise source had never been properly evaluated before, and the results have important implications for the configuration of interferometric antennas.

RESEARCH EXPERIENCE continued

Infrared Search for Primeval Galaxies

Observed blank regions of sky at 2.2 microns, using the 4-meter telescope at Cerro Tololo Interamerican Observatory in Chile and the 1.3-meter telescope at Kitt Peak National Observatory. Absence of red-shifted light from early generations of stars places strong constraints on the process of galaxy formation and evolution.

Optical and Infrared Search for Massive Halos of Galaxies

Set the strongest upper limits to date on the luminosity of massive halos of galaxies, based on an extensive series of infrared observations at Kitt Peak National Observatory and CCD observations at Princeton. This work demonstrated that the dark matter ("missing mass") can not be made of even the dimmest main sequence stars.

Large Scale Anisotropy of the Microwave Background Radiation

Designed low-sidelobe horn antennas which were used on a series of balloon flights which measured the dipole anisotropy of the cosmic background radiation.

PROFESSIONAL ACTIVITIES

1983-84

Organizer, Workshop on Sources and Detectors of Gravitational Radiation, to be held at Institute for Theoretical Physics, Santa Barbara, Spring 1984

1983

Participant, 10th International Conference on General Relativity and Gravitation, Padua, Italy, July 1983

FELLOWSHIPS AND SCHOLARSHIPS

Sept 1978 to June 1981

Garden State Graduate Fellow

Sept 1976 to June 1977

John B. Putnam, Jr. Graduate Fellow

Sept 1972 to June 1976

Harvard National Scholar

TEACHING EXPERIENCE

Sept 1980 to Jan 1981

Assistant in Instruction, Modern Physics
Princeton University

Feb 1978 to June 1980

Assistant in Instruction, Freshman Lab
Princeton University

PETER R. SAULSON

PUBLICATIONS

- 1980 "Search for Luminous Halos of Spiral Galaxies"
with B.H. Siebers, Jr., E.D. Loh, and D.T. Wilkinson
Bull. Am. Soc. 12, 490
(delivered at 156th AAS meeting, June 1980)
- "Large-Scale Anisotropy in the 2.7 K Radiation"
with E.S. Cheng and D.T. Wilkinson
Astrophysical Journal Letters, 232, L139
- 1981 "A New Limit on the Mass-to-Light Ratio of the Halo
of NGC 4565"
with S.P. Boughn and M. Seldner
Astrophysical Journal Letters, 250, L15
and Bull. Am. Astro. Soc. 13, 506
(delivered at 158th AAS meeting, June 1981)
- 1982 "Infrared Search for Primeval Galaxies"
with S.P. Boughn and J.M. Uson
Bull. Am. Astr. Soc. 14, 630
(delivered at 160th AAS meeting, June 1982)
submitted to Astrophysical Journal
- 1983 "Infrared Photometry of the Halo of M87"
with S.P. Boughn
Astrophysical Journal Letters, 265, L55
and Bull. Am. Astr. Soc. 14, 643
- 1984 "Terrestrial Gravitational Noise on a Gravitational
Wave Antenna"
Physical Review D15 30, 732
- "Vibration Isolation for Broad-Band Gravitational
Wave Detectors"
Review of Scientific Instruments 55, 1315
and Bull. Am. Astr. Soc. 14, 940
- "Infrared Search for Dark Matter"
with S.P. Boughn
paper in preparation
- "Transfer Function of Interferometric Gravitational
Wave Antennas"
with Y. Gursel, P.S. Lindsay, R. Weiss,
and S.E. Whitcomb
paper in preparation

CURRICULUM VITAE

ROBERT SPERO

**Department of Physics 130-33
California Institute of Technology
Pasadena, CA. 91125
(818)358-4437**

EDUCATION:

U.C. at Irvine (Ph.D., Physics)	1979
Dissertation Title: A Laboratory Test of the Inverse Square of Gravity Advisor: Riley Newman	
U.C. at Irvine (M.A., Physics)	1976
U.C.L.A. (B.S., Physics)	1973

AREAS OF EXPERTISE

Precision measurement of small forces and displacements, including use of laser interferometry and torsion balance. Stabilization of lasers and resonant optical cavities. Analog and digital electronics for servocontrol and signal processing. High vacuum technology. Precision metrology. Seismic isolation. Programming and interfacing of computers.

POSITIONS:

M.P.S.* (Caltech, Pasadena)	1983--present
Research Fellow (Caltech, Pasadena)	1980--1983
Research Assistant (U.C. at Irvine)	1976--1979

***MEMBER OF THE PROFESSIONAL STAFF**

ROBERT SPERO

PUBLICATIONS

1. A Method to Limit the Muon Neutrino Mass. H.H. Chen, R. Gutierrez-Lee, S.Y. Nakamura, and R.E. Spero; Phys. Lett. 59B, 274 (1975).
2. Experimental Test of the Gravitational Inverse Square Law at Laboratory Distances. R. Newman, J. Pellam, J. Schultz, and R. Spero; presented at GR8, 8th International Conference on General Relativity and Gravitation, 1977.
3. Test of the Gravitational Inverse Square Force Law at Short Distances. R. Spero, J.K. Hoskins, R. Newman, J. Pellam, and J. Schultz; Bul. APS 24, 579 (1979).
4. Test of the Gravitational Inverse-Square Law at Laboratory Distances. R. Spero, J.K. Hoskins, R. Newman, J. Pellam, and J. Schultz; Phys. Rev. Lett. 44, 1645 (1980).
5. Optical Cavity Laser Interferometers for Gravitational Wave Detection. R.W.P. Drever, J. Hough, A.J. Munley, S.-A. Lee, R. Spero, S.E. Whitcomb, H. Ward, G.M. Ford, M. Hereld, N.A. Robertson, I. Kerr, J.R. Pugh, G.P. Newton, B. Meers, E.D. Brooks III, Y. Gursel; Proceedings of the Fifth International Conference on Laser Spectroscopy; June 29 - July 3, 1981, (Jasper, Alberta, Canada).
6. Gravitational Wave Detectors Using Laser Interferometers and Optical Cavities - 1 & 2. R.W.P. Drever, A.J. Munley, J. Hough, S.-A. Lee, R. Spero, S.E. Whitcomb, H. Ward, G.M. Ford, M. Hereld, N.A. Robertson, I. Kerr, J.R. Pugh, G.P. Newton, B. Meers, E.D. Brooks III, Y. Gursel; Proceedings of the Nato Advanced Study Institute "Quantum Optics and Experimental General Relativity", Bad Windsheim, West Germany, August 17 - 19, 1981.
7. Prospects for Ground Based Detectors of Low Frequency Gravitational Radiation. R. Spero; Science Underground (Los Alamos, 1982), AIP Conference Proceeding Number 96.
8. The Caltech Gravitational Wave Detector. R. Spero, D.Z. Anderson, R.W.P. Drever, Y. Gursel, G. Gutt, M. Hereld, J. Kaufman, S.E. Whitcomb; Proceedings on the 10th International Conference on General Relativity and Gravitation, Padova, Italy, 4-9 July 1983.

CURRICULUM VITAE
STANLEY ERNEST WHITCOMB

Department of Physics 130-33
California Institute of Technology
Pasadena, CA. 91125
(818)356-4219

PERSONAL:

Born in Denver, Colorado, January 23, 1951

United States Citizen

Married

EDUCATION:

California Institute of Technology (B.S., Physics)	1969-73
U. of Cambridge (Cert. of Post-Grad Studies, Physics)	1973-74
U. of Chicago (Ph.D., Physics)	1974-80

HONORS:

Harlan Lee Fisher Jr. Award (Caltech)	1972
Sigma Xi Prize (Caltech)	1973
Winston Churchill Fellowship (U. of Cambridge)	1973-74
Enrico Fermi Predoctoral Fellowship (U. of Chicago)	1974-76
Telegdi Prize (U. of Chicago)	1974
Fannie and John Hertz Fellowship (U. of Chicago)	1976-79

POSITIONS:

Undergraduate Research Assistant (Caltech)	1970-72
Undergraduate Teaching Assistant (Caltech)	1972-73
Demonstrator for 2nd Year Physics Lab (U. of Cambridge)	1973-74
Research Assistant (U. of Chicago)	1979-80

National Needs Postdoctoral Fellowship (U. of Chicago)
Assistant Professor of Physics (Caltech)

1980
1980-present

PROFESSIONAL MEMBERSHIPS

American Astronomical Society

American Physical Society

STANLEY ERNEST WHITCOMB

PUBLICATIONS

1. Far-Infrared and Submillimeter Observations of the Planets; R.F. Loewenstein, D.A. Harper, S.H. Moseley, C.M. Telesco, H.A. Thronson, R.H. Hildebrand, S.E. Whitcomb, R. Winston, and R.F. Stiening, Icarus, 31, 315-324 (1977).
2. Submillimeter Photometry of Extragalactic Objects; R.H. Hildebrand, S.E. Whitcomb, R. Winston, R.F. Stiening, D.A. Harper, and S.H. Moseley, Ap. J., 216, 698-705 (1977).
3. Submillimeter Observations of the Galactic Center; R.H. Hildebrand, S.E. Whitcomb, R. Winston, R.F. Stiening, D.A. Harper, and S.H. Moseley, Ap. J. (Letters), 219, L101-L104 (1978).
4. Compact Infrared Heat Trap Field Optics; J. Keene, R.H. Hildebrand, S.E. Whitcomb, and R. Winston, Appl. Optics, 17, 1107-1109 (1978).
5. Submillimeter Brightness Temperatures of Venus, Jupiter, Uranus and Neptune; S.E. Whitcomb, R.H. Hildebrand, J. Keene, R.F. Stiening, and D.A. Harper, Icarus, 38, 75-80 (1979).
6. Millimeter and Submillimeter Measurements of the Crab Nebula; E.L. Wright, D.A. Harper, R.H. Hildebrand, J. Keene, and S.E. Whitcomb, Nature, 279, 703-705 (1979).
7. Low-pass Interference Filters for Submillimeter Astronomy; S.E. Whitcomb and J. Keene, Appl. Optics, 19, 197-198 (1980).
8. Far-Infrared Observations of the Globule B335; J. Keene, D.A. Harper, R.H. Hildebrand, and S.E. Whitcomb, Ap. J. (Letters), 240, L43-L46 (1980).

9. Brightness Temperatures of Saturn's Disk and Rings at 400 and 800 μm ; S.E. Whitcomb, R.H. Hildebrand, and J. Keene, Science , 210, 788 (1980).
10. Search for Far-Infrared Emission From Young Supernove Remnants; E.L. Wright, D.A. Harper, R.F. Loewenstein, J. Keene, and S.E. Whitcomb, Ap. J. (Letters) , 240, L157-L158 (1980).
11. An $f/35$ Submillimeter Photometer for the NASA Infrared Telescope Facility; S.E. Whitcomb, R.H. Hildebrand, and J. Keene, Pub. Astron. Soc. Pacific , 92, 863-869 (1980).
12. Far-Infrared Observations of the Cepheus OB3 Molecular Cloud; N.J. Evans II, E.E. Becklin, C. Beichman, I. Gatley, R.H. Hildebrand, J. Keene, M.H. Slovak, M.W. Werner, and S.E. Whitcomb, Ap. J. , 244, 115-123 (1981).
13. Far-Infrared Properties of Dust in the Reflection Nebula NGC 7023; S.E. Whitcomb, I. Gatley, R.H. Hildebrand, J. Keene, K. Sellgren, and M.W. Werner, Ap. J. , 246, 416-425 (1981).
14. Solar Limb Brightening at 350 μm ; C. Lindsey, R.H. Hildebrand, J. Keene, and S.E. Whitcomb, Ap. J. , 248, 830-835 (1981).
15. A High-Resolution Submillimeter Map of OMC-1; J. Keene, R.H. Hildebrand, and S.E. Whitcomb, Ap. J. (Letters) , 252, L11-L15 (1982).
16. Optical Cavity Laser Interferometers for Gravitational Wave Detection; R.W.P. Drever, J. Hough, A.J. Munley, S-A. Lee, R. Spero, S.E. Whitcomb, H. Ward, G.M. Ford, M. Hereld, N.A. Robertson, I. Kerr, J.R. Pugh, G.P. Newton, B. Meers, E.D. Brooks III, and Y. Gursel, in Proc. of the Fifth International Conference on Laser Spectroscopy, p. 33, (Springer-Verlag, 1981).
17. New Far Infrared Observations of the Central 30' of the Galaxy; W.A. Dent, M.W. Werner, I. Gatley, E.E. Becklin, R. H. Hildebrand, J. Keene, and S.E. Whitcomb, in *The Galactic Center* , ed. G. Riegler and R. Blandford, pp. 33-41 (American Institute of Physics, 1982).

18. *Prospects for Gravitational Astronomy*; S.E. Whitcomb, Bul. A.P. S. , 27, 42 (1982) (Abstract for invited talk).
19. Gravitational Wave Detectors Using Laser Interferometers and Optical Cavities - 1 - Ideas, Principles and Prospects. R.W.P. Drever, J. Hough, A.J. Munley, S.-A. Lee, R. Spero, S.E. Whitcomb, H. Ward, G.M. Ford, M. Hereld, N.A. Robertson, I. Kerr, J.R. Pugh, G.P. Newton, B. Meers, E.D. Brooks III, and Y. Gursel, in *Quantum Optics, Experimental Gravity and Measurement Theory*, (des. Pierre Meystere and Marlan O. Scully), Plenum Publishing, 1983, 503-514.
20. Gravitational Wave Detectors Using Laser Interferometers and Optical Cavities - 2 - Some Practical Aspects and Results; J. Hough, R.W.P. Drever, A.J. Munley, S.-A. Lee, R. Spero, S.E. Whitcomb, H. Ward, G.M. Ford, M. Hereld, N.A. Robertson, I. Kerr, J. Pugh, G.P. Newton, B. Meers, E.D. Brooks III, and Y. Gursel in *Quantum Optics, Experimental Gravity and Measurement Theory*, eds. Pierre Meystre and Marlan O. Scully, (Plenum Publishing), 1983.
21. Laser Interferometer Experiments at Caltech; S.E. Whitcomb, D.Z. Anderson, R.W.P. Drever, Y. Gursel, M. Hereld, and R. Spero, in Proc. of the Third Marcel Grossmann Meeting on General Relativity, Shanghai (1982, in press).
22. Developments in Laser Interferometer Gravitational Wave Detectors; R.W.P. Drever, S. Hoggan, J. Hough, B.J. Meers, A.J. Munley, G.P. Newton, H. Ward, D.Z. Anderson, Y. Gursel, M. Hereld, R.E. Spero, and S.E. Whitcomb, in Proc. of the Third Marcel Grossmann Meeting on General Relativity, Shanghai (1982, in press).
23. Submillimeter Observations of W3; D.T. Jaffe, R.H. Hildebrand, J. Keene, and S.E. Whitcomb, Ap. J. (Letters) , (in press).

Frank L. Schutz

Mr. Schutz is Manager of the Gravitational Wave Detection Project in residence at the California Institute of Technology. He was formerly Manager of the Jet Propulsion Laboratory (JPL) Office of Engineering and Review Assessment. His responsibilities involved the audit of the review process to insure that specific requirements placed on all formal reviews were met. Additionally, he was responsible for the implementation of the standards program, a process of consolidating all standards used at the Laboratory into a single database and making that database readily accessible. He was also Project Manager of the Interactions Measurements Payload for Shuttle, an Air Force program designed to measure the effects of the polar/ auroral environment on large space structures, such as the Shuttle, which pass through the environment repeatedly.

He recently established and taught a course in the management of tasks (small projects) at the Laboratory. This course was based on the lectures on program and project management that he gives at the Caltech Industrial Relations Center and to a number of local aerospace organizations. This is the core course of a group of lectures relating to project management practices and techniques that are being set up as a part of the Laboratory's continuing education program.

In past positions he has been responsible for project management and program development activities at Ball Aerospace, Beckman Instruments, Analog Technology Corporation, Space General and the Jet Propulsion Laboratory.

Mr. Schutz attended Stanford University on an Honors Cooperative scholarship from General Telephone (Sylvania Electric Products). His technical publications deal with the implementation of aerospace scientific instruments and management activities required to bring them to a successful conclusion.

Frank L. Schutz

Education and Publications

College of San Mateo	1953-1958
Stanford University (BSEE)	1958-1960

1. F.L. Schutz, "*Incorporation of Scientific Instruments Into Deep Space Probes*," Proceedings of 1964 IEEE International Convention, New York, March 1964.
2. F.L. Schutz, "*The Mariner/Mars Mission and Spacecraft*," Proceedings of the 1965 WESCON, San Francisco, August 1965. (Also published in JPL Technical Report TM 32-813).
3. W.G. Fawcett, R.V. Meghreblian, F.L. Schutz, "*Science Payloads from Mariner II to Mariner IV*," Proceedings of the Conference on the Exploration of Venus and Mars, Virginia Polytechnic Institute, August 1965.
4. F.L. Schutz, "*The Intergration of Scientific Instruments Into Mariner IV*," Proceedings of the International Astronautical Federation, Athens, Greece, September 1965.
5. F.L. Schutz, "*Scientific Projects of Mariner IV*," R/D, Research/Development, 16, No. 9, September 1965.
6. W.G. Fawcett, F.L. Schutz, R.K. Sloan, H.G. Trostel, "*Scientific Exploration With Mariner IV*," *Astronautics and Aeronautics*, October 1965.
7. F.L. Schutz, "*The Mariner IV Science Subsystem*," Proceedings of the 1965 International Space Electronics Symposium, Miami, Florida, November 1965.
8. F.L. Schutz, "*Focus '66, Instrumentation Growing Step-by-Step*," *Electronic Design*, 14, No. 1, January 4, 1966.

9. J.S. Bunn, L.D. Bowman, C.S. Josias, O. Maloy, and F.L. Schutz, "*A Study of Instrumentation for a Gas Chromatograph Using Flame Ionization Detection - Final Report*," December 5, 1966.
10. L.D. Bowman, J.A. Collins, C.S. Josias, J.L. Lawrence, F.L. Schutz, and P. Smith, "*An Interim Study Report on Electronics for the Nimbus-D Backscatter Ultraviolet Instrument*," ATC Internal Report No. 7, January 1968.
11. C.S. Josias, J.L. Lawrence, F.L. Schutz, and P. Smith, "*Electronics for the Nimbus-D Backscatter Ultraviolet Instrument*," IEEE Geoscience Symposium, Washington, D.C., September 1971.

Frank L. Schutz

- California Institute of Technology, Pasadena, CA** **1984-Date**
Manager, Gravitational Wave Facilities
Responsible for the Conceptual, Engineering Design
and Implementation of these facilities
- Jet Propulsion Laboratory, Pasadena, CA** **1982-1984**
Manager, Office of Engineering & Review Assessment
Responsible for all formal reviews
Engineering standards program implementation
Manager, Interactions Measurement Payload for Shuttle
Responsible for establishing the project
Formation of the Engineering/Science Working Group
- Jet Propulsion Laboratory, Pasadena, CA** **1982**
Project Manager, Salton Sea Solar Pond Power Plant Project
Responsible for the design, development, and operation
of a 5 megawatt experimental solar power plant
Responsible for a major A&E contractor and a
foreign equipment supplier
Responsible for interfacing with three sponsors
having diverse objectives
- California Institute of Technology Industrial Relations Center** **1981-Date**
Member of Staff
Lectures in Project Management

Jet Propulsion Laboratory, Pasadena, CA. 1980-1982

**Project Manager, Advanced Microwave
Sunder Unit Project**

Responsible for developing a comprehensive technical
and management project plan for a major
new operational
temperature sounder

Jet Propulsion Laboratory, Pasadena, CA. 1979-1982

**Project Manager, Shuttle Atmospheric Trace Molecule
Spectroscopy Project**

Responsible for resolving schedule and cost problems
Management of a major contractor

Jet Propulsion Laboratory, Pasadena, CA. 1979

Manager, HEAD-III Gamma Ray Spectrometer Experiment

Responsible for resolving performance,
schedule and cost problems
Managed interface with Mission Spacecraft contractors,
Instrument subcontractor, and NASA Center

Jet Propulsion Laboratory, Pasadena, CA. 1976-1979

Deputy Manager, Observational Systems Division

Responsible for all flight instruments in the Division
Provide leadership of and direction to the
Flight Experiments, Flight Project Representatives,
and the Division-level Instrument & Experiment Managers
Conduct periodic reviews of all flight programs
Establish review policies & procedures for flight instruments
Propose policies & procedures for flight proposals

Asst. Div. Manager, Earth & Space Sciences Division

Manage all engineering activities in the Earth and
Space Sciences Division

System Manager, Seasat Synthetic Aperture Radar

Responsible for system functional requirements interface
control, test requirements, end-to-end system performance,
and resources control

Ball Brothers Research Corp., Gardena, CA

1974-1976

Advanced Projects Manager

Responsible for project planning and
advanced program development

Beckman Instruments (ATO), Anaheim, CA

1972-1974

Chief Project Engineer

Responsible for project & technical management

Analog Technology Corporation, Pasadena, CA

1966-1972

Manager, Program Development Division

Formulate, develop, & direct corporate marketing activities
Direct supporting activities such as corporate
communications, publication services, and public relations
Investigate new business areas

Manager, Systems Division

Direct instrument system design
Participate in the design, development, test, and
operation of GSE/AGE systems
Serve as Project Manager for various NASA Programs

Space-General Corp., El Monte, CA

1965-1966

Senior Engineering Specialist

Responsible for Ground Support Equipment
for ALSEP Study Program

Jet Propulsion Laboratory, Pasadena, CA.

1960-1965

Staff Engineer

Responsible for engineering aspects of Voyager Science

Served as Project Engineer for Mariner 3 & 4

Science Subsystem

Engineering Group Supervisor

Responsible for design of scientific systems

for Mariner spacecraft

Directed group responsibilities which included

spacecraft instruments and their ancillaries

Research Engineer

Provided system support for early Mariner missions

Sylvania Electric Products (EDL), Mt. View, CA.

1953-1960

Technician/Technical Associate/Sr. Engineer

Responsible for antenna range development & operations

Designed antenna and microwave systems

Dalmo-Victor, Belmont, CA.

1953-1955

Microwave Technician

Antenna performance measurements

Microwave Antenna system test

U.S. Navy

1947-1953

Electronic Technician 1st. Class

APPENDIX VI

**SUMMARY OF ALL CURRENT AND PENDING RESEARCH SUPPORT
[FROM WHATEVER SOURCE]**

The following information should be provided for each investigator and other senior personnel (see p. 6). Failure to provide this information may delay consideration of the proposal.

	A	B	C	D	E ¹	F
	Source of Support ³	Project Title ²	Award Amount (or Annual Rate)	Period Covered By Award	Person-Months Or % of Effort Committed To The Project	Location Where Research Is/Will Be Per- formed
ACAD. SUMM.						
I. (Name of Principal Investigator)	R.W.P. DREVER					
A. Current Support				7-84		
List—If none, Report none	NSF	#1	\$ 649,100.	6-85	75%	100%
B. Proposals Pending				6-85		Caltech
1. List this proposal	NSF	#2	\$6,700,000.	7-86	30%	30%
2. Other pending proposals, including renewal applica- tions. If none, report none.				6-85		Caltech
3. Proposals planned to be submitted in near future. If none, report none.	NSF	#3	\$8015,000.	5-90	45%	70%
	---	---	---	---	---	---
II. (Name of co-principal investigator and/or faculty associate)	---	---	---	---	---	---
A.						
B.						
III. Transfer of Support						
If this project has previously been funded by another agency, please list and furnish information for immediately preceding funding period.	---	---	---	---	---	---
IV. (Other agencies to which this proposal has been/will be submitted)	---					

¹ Non-academic researchers may report percentage of total research effort using the first column only.

² Entry of project title should be by number coding (i.e., 1,2,...) and the full titles should be identified according to number at the bottom of the form (i.e., 1. full title; 2. full title....)

³ Include NSF, other Federal and State Agencies, and private sources.

USE ADDITIONAL SHEETS AS NECESSARY

1. INVESTIGATION IN EXPERIMENTAL GRAVITY & GRAVITATIONAL RADIATION
3. INVESTIGATIONS IN EXPERIMENTAL GRAVITY AND GRAVITATIONAL RADIATION
2. FEASIBILITY AND DESIGN STUDIES FOR A LASER INTERFEROMETEP. GRAVITATIONAL WAVE DETECTION SYSTEM.

APPENDIX VI

**SUMMARY OF ALL CURRENT AND PENDING RESEARCH SUPPORT
[FROM WHATEVER SOURCE]**

The following information should be provided for each investigator and other senior personnel (see p. 6). Failure to provide this information may delay consideration of the proposal.

	A	B	C	D	E ¹	F
	Source of Support ³	Project Title ²	Award Amount (or Annual Rate)	Period Covered By Award	Person-Months Or % of Effort Committed To The Project	Location Where Research Is/Will Be Per- formed
ACAD. SUMM.						
I. (Name of Principal Investigator)	RAINER WEISS:			8-84-		
A. Current Support	CURRENT SUPPORT			1-85	10%	0%
List—if none, Report none	NSF	#1 \$ 206,393.				MIT
B. Proposals Pending				8-83-		
1. List this proposal	NASA	#2 \$1572,552.		10-89	10%-23%	50%
2. Other pending proposals, including renewal applications. If none, report none.	NSF	#3 \$6700,000.		6-85 7-86		MIT
3. Proposals planned to be submitted in near future. If none, report none.	NSF	#4 \$8012,321.		6-85 5-90	23.2%	50%
II. (Name of co-principal investigator and/or faculty associate)	NASA WASHINGTON #5. \$100,000.			11-84 10-85	0-5%	0%
A.						MIT
B.						
III. Transfer of Support						
If this project has previously been funded by another agency, please list and furnish information for immediately preceding funding period.						
IV. (Other agencies to which this proposal has been/will be submitted)						

¹ Non-academic researchers may report percentage of total research effort using the first column only.

² Entry of project title should be by number coding (i.e., 1,2,...) and the full titles should be identified according to number at the bottom of the form (i.e., 1. full title; 2. full title....)

³ Include NSF, other Federal and State Agencies, and private sources.

1. BROAD-BAND GRAVITATIONAL ANTENNA
2. COBE SATELLITE MISSION
3. FEASIBILITY AND DESIGN STUDIES FOR A LASER INTERFEROMETER GRAVITATIONAL WAVE
USE ADDITIONAL SHEETS AS NECESSARY DETECTION SYSTEM
4. INTERFEROMETRIC BROAD-BAND GRAVITATIONAL ANTENNA
5. ASTRONOMY IN THE REGION BETWEEN 1mm AND 0.1mm WAVELENGTHS