



MASSACHUSETTS INSTITUTE OF TECHNOLOGY

77 MASSACHUSETTS AVENUE ROOM E19-702
CAMBRIDGE, MASS. 02139

OFFICE OF SPONSORED PROGRAMS

April 15, 1981

TELEPHONE (617) 253-6975

OSP #87407

National Science Foundation
Central Processing Section
1800 G. Street
Washington, D.C. 20550

Attn: Dr. Richard Isaacson

Re: Renewal Proposal for Grant No. PHY-8109581

To whom it may concern:

Massachusetts Institute of Technology submits herewith ten(10) copies of the above-referenced renewal proposal entitled "Interferometric Broad Band Gravitational Antenna" to be performed under the supervision of Professor Rainer Weiss of M.I.T.'s Department of Physics.

This proposal is submitted for the period June 1, 1981 through May 31, 1984 at a total estimated cost of \$1,282,600, with an annual estimated breakdown as follows:

First Year:	\$337,719
Second Year:	\$467,509
Third Year:	\$477,382

If you have any further questions, please do not hesitate to contact the undersigned at the above-referenced number.

Sincerely,

Maureen Kelleher
Maureen Kelleher
Assistant Director

MK/pav
ENCLOSURES
cc: Prof. R. Weiss
D. Gould

EXHIBIT II-3

PROPOSAL TO THE NATIONAL SCIENCE FOUNDATION
Cover Page

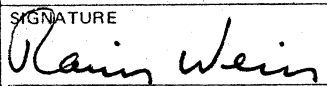
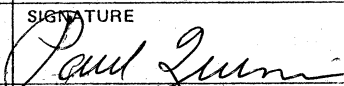
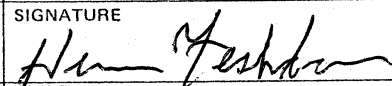
FOR CONSIDERATION BY NSF ORGANIZATIONAL UNIT (please specify):		
Physics ATT: Dr. Richard A. Isaacson		
PROGRAM ANNOUNCEMENT/SOLICITATION NO.:	CLOSING DATE (IF ANY):	
Proposal ID# PHY-8109581		
NAME OF SUBMITTING ORGANIZATION TO WHOM AWARD SHOULD BE MADE (INCLUDE BRANCH/CAMPUS/OTHER COMPONENTS)		
Massachusetts Institute of Technology		Physics Department
ADDRESS OR ORGANIZATION (INCLUDE ZIP CODE)		
77 Massachusetts Avenue Cambridge, MA 02139		
TITLE OF PROPOSED PROJECT		
Interferometric Broad Band Gravitational Antenna		
REQUESTED AMOUNT	PROPOSED DURATION	DESIRED STARTING DATE
\$1,282,600	3 Years	June 1, 1981
PI/PD NAME AND SOCIAL SECURITY NO. (SSN)*		PI/PD PHONE NO.
Rainer Weiss 128-26-6401		617-253-4824
PI/PD DEPARTMENT		PI/PD ORGANIZATION
Physics		
ADDITIONAL PI/PD AND SSN*		ADDITIONAL PI/PD AND SSN*
Paul Linsay		
ADDITIONAL PI/PD AND SSN*		ADDITIONAL PI/PD AND SSN*
FOR RENEWAL OR CONTINUING AWARD REQUEST, LIST PREVIOUS AWARD NO.:		
REMARKS: *Submission of social security numbers is voluntary and will not affect the organization's eligibility for an award. However, they are an integral part of the NSF information system and assist in processing the proposal.		
Revision to Proposal # PHY-8109581		
PRINCIPAL INVESTIGATOR/ PROJECT DIRECTOR	AUTHORIZED ORGANIZATIONAL REP.	OTHER ENDORSEMENT (optional)
NAME	NAME	NAME
Rainer Weiss	Paul Quinn	Herman Feshbach
SIGNATURE	SIGNATURE	SIGNATURE
		
TITLE	TITLE	TITLE
Professor Physics	Associate Director of Sponsored Programs	Department Head
DATE	DATE	DATE
4/14/81	4/15/81	

Renewal Proposal Submitted to the National Science Foundation

Proposed Amount \$1,282,600

Proposed Effective Date June 1, 1981

Proposed Duration 36 months

Title: "Interferometric Broad Band Gravitational Antenna"

Principal Investigator: Rainer Weiss

Social Security No.: 128-26-6401

Room Number: 20F-001

Make Grant to: Massachusetts Institute of Technology

Submitted by

Massachusetts Institute of Technology
Department of Physics
77 Massachusetts Avenue
Cambridge, Massachusetts 02139

Endorsements

Principal Investigator

Rainer Weiss

Rainer Weiss
Professor
Department of Physics
Tel: (617) 253-3527

Date: 4/14/81

Co-Investigator

Paul S. Linsay

Paul S. Linsay
Principal Scientist
Department of Physics
Tel: (617) 253-4824

Date: April 14, 1981

Department Chairman

Herman Feshbach

Herman Feshbach
Chairman
Department of Physics
Tel: (617) 253-4801

Date: _____

Institution Admin. Official

Paul Quinn

Paul Quinn
Associate Director
Office of Sponsored Programs
Tel: (617) 253-3906

Date: 4/10/81

ORGANIZATION MIT, Physics Department, Cambridge, MA 02139		PROPOSAL NO.		DURATION (MONTHS)	
PRINCIPAL INVESTIGATOR/PROJECT DIRECTOR Rainer Weiss		AWARD NO.		Proposed	Granted
A. SENIOR PERSONNEL: PI/PD, Co-PI's, Faculty and Other Senior Associates (List each separately with title; A.6. show number in brackets)		NSF FUNDED PERSON-MOS.		FUNDS REQUESTED BY PROPOSER	
		CAL.	ACAD	SUMR	(IF DIFFERENT)
1. Rainer Weiss - P.I.			1	1	\$ 8,600
2. Paul S. Linsay - Co-P.I.		12			24,000
3. Shaoul Ezekiel - Faculty Associate			1/2	1	6,270
4. Edward L. Wright - Faculty Associate			1/2		1,130
5. () OTHERS (LIST INDIVIDUALLY ON BUDGET EXPLANATION PAGE)					
6. (4) TOTAL SENIOR PERSONNEL (1-5)					
B. OTHER PERSONNEL (SHOW NUMBERS IN BRACKETS)					
1. () POST DOCTORAL ASSOCIATES					
2. (3) OTHER PROFESSIONALS (TECHNICIAN, PROGRAMMER, ETC.)		30			55,050
3. (2) GRADUATE STUDENTS					30,400
4. () UNDERGRADUATE STUDENTS					
5. (1) SECRETARIAL-CLERICAL					1,000
6. () OTHER					
TOTAL SALARIES AND WAGES (A+B)					126,450
C. FRINGE BENEFITS (IF CHARGED AS DIRECT COSTS)					25,664
TOTAL SALARIES, WAGES AND FRINGE BENEFITS (A+B+C)					151,114
D. PERMANENT EQUIPMENT (LIST ITEM AND DOLLAR AMOUNT FOR EACH ITEM EXCEEDING \$1,000; ITEMS OVER \$10,000 REQUIRE CERTIFICATION)					
(see additional page)					
TOTAL PERMANENT EQUIPMENT					34,920
E. TRAVEL 1. DOMESTIC (INCL. CANADA AND U.S. POSSESSIONS)					500
2. FOREIGN					
F. PARTICIPANT SUPPORT COSTS					
1. STIPENDS \$ _____					
2. TRAVEL _____					
3. SUBSISTENCE _____					
4. OTHER _____					
TOTAL PARTICIPANT COSTS					
G. OTHER DIRECT COSTS					
1. MATERIALS AND SUPPLIES (see additional page)					23,000
2. PUBLICATION COSTS/PAGE CHARGES					500
3. CONSULTANT SERVICES					30,000
4. COMPUTER (ADPE) SERVICES					
5. SUBCONTRACTS					
6. OTHER					
TOTAL OTHER DIRECT COSTS					
H. TOTAL DIRECT COSTS (A THROUGH G)					241,034
I. INDIRECT COSTS (SPECIFY) (Overhead)					
TOTAL INDIRECT COSTS					96,685
J. TOTAL DIRECT AND INDIRECT COSTS (H + I)					337,719
K. RESIDUAL FUNDS (IF FOR FURTHER SUPPORT OF CURRENT PROJECTS GPM 252 AND 253)					
L. AMOUNT OF THIS REQUEST (J) OR (J MINUS K)					\$ 337,719

PI/PD TYPED NAME & SIGNATURE* Rainer Weiss <i>Rainer Weiss</i>		DATE 4/15/81	FOR NSF USE ONLY		
INST. REP. TYPED NAME & SIGNATURE* Paul H. Quinn <i>Paul H. Quinn</i>		DATE 4/15/81	Date Checked	Date of Rate Sheet	Initials - DGC

1981/1982 EQUIPMENT AND SUPPLIES

EQUIPMENT

Digital Storage Scope		
Textronix #463	\$5,600	
Signal Averaging	200	
Cart: #200 C	235	
2 Probes: P6063B	<u>320</u>	
	\$6,355	\$ 6,355
6 NIMBINS and Power Supplies		
Ortec 401A/402D		7,050
6 High Voltage Supplies		
Power Designs #1570		3,450
LSI-11 Microprocessor		
Floating Point Processor		
11/23 Microprocessor		
Twin Floppy Discs		
IEEE-488 Interface		
Graphics Terminal	15,600	
11% Discount	<u>- 1,716</u>	
	13,884	
Fortran (Fully Supported)	<u>2,900</u>	
	\$16,784	16,784
Oscilloscope Amplifier		
Textronix 7A18	1,080	
Option 06 DC Offset	<u>200</u>	
	\$1,280	<u>1,280</u>
TOTAL		\$34,920

EXPENDABLE SUPPLIES AND SERVICES

Replacement Discharge Tube for Spectra Physics #165-03 Laser	\$ 5,990
Miscellaneous Optical Components	2,000
Shop Time and Materials	5,000
Electronic Components	<u>10,000</u>
TOTAL	\$23,000

PROPOSAL BUDGET

FOR NSF USE ONLY		
PROPOSAL NO.	DURATION (MONTHS)	
	Proposed	Granted
AWARD NO.		

ORGANIZATION
MIT, Physics Department, Cambridge, MA 02139

PRINCIPAL INVESTIGATOR/PROJECT DIRECTOR
Rainer Weiss

A. SENIOR PERSONNEL: PI/PD, Co-PI's, Faculty and Other Senior Associates (List each separately with title; A.6. show number in brackets)	NSF FUNDED PERSON-MOS.		FUNDS REQUESTED BY PROPOSER	FUNDS GRANTED BY NSF (IF DIFFERENT)
	CAL.	ACADSUMR		
1. Rainer Weiss - P.I.		1 1	\$ 9,500	\$
2. Paul S. Linsay - Co-P.I.	12		26,400	
3. Shaoul Ezekiel - Faculty Associate		1/2 1	6,900	
4. Edward L. Wright - Faculty Associate		1/2	1,240	
5. () OTHERS (LIST INDIVIDUALLY ON BUDGET EXPLANATION PAGE)				
6. (4) TOTAL SENIOR PERSONNEL (1-5)				
B. OTHER PERSONNEL (SHOW NUMBERS IN BRACKETS)				
1. () POST DOCTORAL ASSOCIATES				
2. (3) OTHER PROFESSIONALS (TECHNICIAN, PROGRAMMER, ETC.)	30		65,200	
3. (2) GRADUATE STUDENTS			33,400	
4. () UNDERGRADUATE STUDENTS				
5. (1) SECRETARIAL-CLERICAL			1,000	
6. () OTHER				
TOTAL SALARIES AND WAGES (A+B)			142,640	
C. FRINGE BENEFITS (IF CHARGED AS DIRECT COSTS)			30,041	
TOTAL SALARIES, WAGES AND FRINGE BENEFITS (A+B+C)			172,681	
D. PERMANENT EQUIPMENT (LIST ITEM AND DOLLAR AMOUNT FOR EACH ITEM EXCEEDING \$1,000; ITEMS OVER \$10,000 REQUIRE CERTIFICATION)				
(see additional page)				
TOTAL PERMANENT EQUIPMENT			68,256	
E. TRAVEL 1. DOMESTIC (INCL. CANADA AND U.S. POSSESSIONS)				
2. FOREIGN			500	
F. PARTICIPANT SUPPORT COSTS				
1. STIPENDS \$ _____				
2. TRAVEL _____				
3. SUBSISTENCE _____				
4. OTHER _____				
TOTAL PARTICIPANT COSTS				
G. OTHER DIRECT COSTS				
1. MATERIALS AND SUPPLIES (see additional page)			21,000	
2. PUBLICATION COSTS/PAGE CHARGES			1,000	
3. CONSULTANT SERVICES			100,000	
4. COMPUTER (ADPE) SERVICES				
5. SUBCONTRACTS				
6. OTHER				
TOTAL OTHER DIRECT COSTS				
H. TOTAL DIRECT COSTS (A THROUGH G)			364,437	
I. INDIRECT COSTS (SPECIFY)				
(overhead)				
TOTAL INDIRECT COSTS			103,072	
TOTAL DIRECT AND INDIRECT COSTS (H + I)			467,509	
RESIDUAL FUNDS (IF FOR FURTHER SUPPORT OF CURRENT PROJECTS GPM 252 AND 253)				
AMOUNT OF THIS REQUEST (J) OR (J MINUS K)			\$ 467,509	\$

PI/PD TYPED NAME & SIGNATURE*	DATE	FOR NSF USE ONLY		
Rainer Weiss <i>Rainer Weiss</i>	4/15/81	INDIRECT COST RATE VERIFICATION		
PI/REP. TYPED NAME & SIGNATURE*	DATE	Date Checked	Date of Rate Sheet	Initials - DGC
Paul H. Quinn <i>Paul H. Quinn</i>	4/17/81			

1982/1983 EQUIPMENT AND SUPPLIES

VAX-11/750 Computer		
VAX-11/750 CPU		
1 Mbyte Memory		
4 Kbyte Cache Memory		
RM 03 Disc Drive		
TS11 CA Tape Drive		
LA 38 Hardcopy Unit		
VAX Operating System		
5 Weeks of Training	\$ 125,000	
Educational Discount	- <u>14,300</u>	
	\$ 110,700	\$ 110,700
Fortran (Fully Supported)		
QD 100 AG		8,000
VS11 Graphics Terminal		10,000
Maintenance Contract		
Basic Service Agreement		7,812
	TOTAL	<u>136,512</u>
NASA contribution COBE Project		<u>68,256</u>
TOTAL FOR COMPUTER		\$ 68,256

EXPENDABLE SUPPLIES AND SERVICES

Miscellaneous Optical Components	\$ 4,000
Shop Time and Materials	5,000
Electronic Components	10,000
Vacuum Plumbing	<u>2,000</u>
TOTAL	\$ 21,000

MIT, Physics Department, Cambridge, MA 02139
 PRINCIPAL INVESTIGATOR/PROJECT DIRECTOR

PROPOSAL NO.	DURATION (MONTHS)	
	Proposed	Granted
AWARD NO.		

Rainer Weiss

A. SENIOR PERSONNEL: PI/PD, Co-PI's, Faculty and Other Senior Associates (List each separately with title; A.6. show number in brackets)	NSF FUNDED PERSON-MOS.			FUNDS REQUESTED BY PROPOSER	FUNDS GRANTED BY NSF (IF DIFFERENT)
	CAL.	ACAD.	SUMR.		
1. Rainer Weiss - P.I.		1	1	\$ 10,450	\$
2. Paul S. Linsay - Co-P.I.	12			29,040	
3. Shaoul Ezekiel - Faculty Associate		1/2	1	7,590	
4. Edward L. Wright - Faculty Associate		1/2	1	1,364	
5. () OTHERS (LIST INDIVIDUALLY ON BUDGET EXPLANATION PAGE)					
6. (4) TOTAL SENIOR PERSONNEL (1-5)					
B. OTHER PERSONNEL (SHOW NUMBERS IN BRACKETS)					
1. () POST DOCTORAL ASSOCIATES					
2. (3) OTHER PROFESSIONALS (TECHNICIAN, PROGRAMMER, ETC.)	30			71,720	
3. (2) GRADUATE STUDENTS				36,740	
4. () UNDERGRADUATE STUDENTS					
5. (1) SECRETARIAL-CLERICAL				2,000	
6. () OTHER					
TOTAL SALARIES AND WAGES (A+B)				156,904	
C. FRINGE BENEFITS (IF CHARGED AS DIRECT COSTS)				33,045	
TOTAL SALARIES, WAGES AND FRINGE BENEFITS (A+B+C)				189,949	
D. PERMANENT EQUIPMENT (LIST ITEM AND DOLLAR AMOUNT FOR EACH ITEM EXCEEDING \$1,000; ITEMS OVER \$10,000 REQUIRE CERTIFICATION)					
(see additional page)					
TOTAL PERMANENT EQUIPMENT				47,000	
E. TRAVEL 1. DOMESTIC (INCL. CANADA AND U.S. POSSESSIONS)				800	
2. FOREIGN					
F. PARTICIPANT SUPPORT COSTS					
1. STIPENDS	\$				
2. TRAVEL					
3. SUBSISTENCE					
4. OTHER					
TOTAL PARTICIPANT COSTS					
G. OTHER DIRECT COSTS					
1. MATERIALS AND SUPPLIES	(see additional page)			22,000	
2. PUBLICATION COSTS/PAGE CHARGES				3,000	
3. CONSULTANT SERVICES				100,000	
4. COMPUTER (ADPE) SERVICES					
5. SUBCONTRACTS					
6. OTHER					
TOTAL OTHER DIRECT COSTS					
H. TOTAL DIRECT COSTS (A THROUGH G)				364,749	
I. INDIRECT COSTS (SPECIFY)					
(overhead)					
TOTAL INDIRECT COSTS				112,633	
J. TOTAL DIRECT AND INDIRECT COSTS (H + I)				477,382	
K. RESIDUAL FUNDS (IF FOR FURTHER SUPPORT OF CURRENT PROJECTS GPM 252 AND 253)					
L. AMOUNT OF THIS REQUEST (J) OR (J MINUS K)				\$477,382	\$

PI/PD TYPED NAME & SIGNATURE Rainer Weiss <i>Rainer Weiss</i>	DATE 4/15/81	FOR NSF USE ONLY		
INST. REP. TYPED NAME & SIGNATURE Paul H. Quinn <i>Paul H. Quinn</i>	DATE 4/15/81	INDIRECT COST RATE VERIFICATION		
	Date Checked	Date of Rate Sheet	Initials - DGC	

1983/1984 EQUIPMENT AND SUPPLIES

Argon Ion Laser		
Spectra Physics #171-05 (or equivalent)	\$	36,900
Tektronix Oscilloscope		
7704A Mainframe		4,220
2: 7A26 Amplifier	\$1,745	3,490
7B80 Time Base	1,190	
Option 02, X-7	<u>100</u>	
	\$1,290	1,290
7B85 Delaying Time Base		1,425
Tek Lab Cart Model 3		<u>425</u>
	\$	10,850

MATERIALS AND SERVICES

Optical Components	\$	4,000
Shop Time and Materials		6,000
Electronic Components		10,000
Vacuum Supplies		2,000

NOTICE OF RESEARCH PROJECT
SCIENCE INFORMATION EXCHANGE
SMITHSONIAN INSTITUTION
NATIONAL SCIENCE FOUNDATION
PROJECT SUMMARY

SIE PROJECT NO.

NSF AWARD NO.

FOR NSF USE ONLY

DIRECTORATE/DIVISION	PROGRAM OR SECTION	PROPOSAL NO.	F.Y.
----------------------	--------------------	--------------	------

NAME OF INSTITUTION (INCLUDE BRANCH/CAMPUS AND SCHOOL OR DIVISION)

Massachusetts Institute of Technology

ADDRESS (INCLUDE DEPARTMENT)

Department of Physics
77 Massachusetts Avenue
Cambridge, MA 02139

PRINCIPAL INVESTIGATOR(S)

Rainer Weiss, Principal Investigator; Paul S. Linsay, Co-Investigator

TITLE OF PROJECT

"Interferometric Broad Band Gravitational Antenna"

TECHNICAL ABSTRACT (LIMIT TO 22 PICA OR 18 ELITE TYPEWRITTEN LINES)

We are continuing the development of a prototype laser interferometric gravitational antenna, and will begin a study of the design of a large antenna (10 km arms) that will be capable of measuring astrophysically interesting sources. Antennas of this type are based on ranging between virtually free masses that follow the time-dependent gravitational strains in a gravitational wave. This type of antenna is broadband, sensitive to differential excitation of tensor gravitational wave polarization, and can be extended to baselines comparable to the gravitational wavelength. Being broadband, antennas of this style can detect periodic and transient sources and can be used as gravitational radiation radiometers to measure the spectral density of incoherent gravitational wave noise.

1. Proposal Folder
2. Program Suspense
3. Division of Grants & Contracts
4. Science Information Exchange
5. Principal Investigator
6. Off. of Govt. & Pub. Progs.

TABLE OF CONTENTS

ABSTRACT ii

PROPOSAL OF RESEARCH 1

RESEARCH PLAN AND BUDGET NARRATIVE 22

COMPUTER 26

PROGRESS DURING 1980 28

BUDGET - 1981/1982 38

BUDGET - 1982/1983 41

BUDGET - 1983/1984 43

APPENDIX I - ACTIVE SEISMIC ISOLATION 45

APPENDIX II - DESCRIPTION OF PROTOTYPE ANTENNA 54

OTHER SOURCES OF SUPPORT 58

BIOGRAPHICAL SKETCHES

 R. Weiss 59

 P. Lindsay 62

 S. Ezekiel 64

 E. Wright 70

LETTERS OF INTENT AND RESUMES

 Stone and Webster Engineering Corporation Boston, MA

 Arthur D. Little, Inc. Cambridge, MA

ABSTRACT

We propose to continue the development of a prototype laser interferometric gravitational antenna, and to begin a study for the design of a large antenna (10 km arms) that will be capable of measuring astrophysically interesting sources. Antennas of this type are based on ranging between virtually free masses that follow the time-dependent gravitational strains in gravitational wave. This type of antenna is broadband, sensitive to differential excitation of tensor gravitational wave polarization, and can be extended to baselines comparable to the gravitational wavelength. Being broadband, antennas of this style can detect periodic and transient sources, and be used as gravitational radiation radiometers to measure the spectral density of incoherent gravitational wave noise. In addition, we will continue research into active isolation stages.

The purpose of the prototype antenna is to understand the noise sources in the system, and to understand the validity of the noise models. The active isolation stage currently works in one dimension, and will be extended to two, and possibly three, dimensions, in order to understand the problems that arise from cross-coupling between modes. This type of stage will be important in the construction of a large antenna.

Parallel to this work, we would like to begin studying the design and construction of a large scale (10 km) interferometric gravity antenna. The study will address the engineering, construction problems, and costs of a large system. We expect that this study will take roughly three years to complete.

PROPOSAL OF RESEARCH

The scientific rationale for the research we propose has not changed in the past year. It is to ultimately detect or set astrophysically interesting limits to the gravitational radiation flux incident on the Earth. No discoveries in the recent past have made the aim of this research less compelling. Indeed, the continued advance in both theoretical understanding of ultradense relativistic matter in the universe, as well as the accumulating evidence that there are strange things afoot in galactic nuclei (including ours), objects moving near limiting speed, and relativistic mechanisms in double radio sources, all are making the concept of gravitational astronomy as a probe to these processes a more urgent and timely research field. We will even go so far as to say that at MIT there is an awakening and more optimism for the success of such an effort.

A good place to begin is with the now familiar Figs. 1 and 2, which show the best estimates and upper limits (in 1978) of the astrophysical gravitational radiation spectrum for three classes of gravitational radiation sources -- impulsive, periodic, and a stochastic background. The estimates, poor as they may be, have not changed substantially since this compilation. Associated with these estimates are the anticipated performance (again made in 1978) for different types of antenna systems. There is no new information which changes the estimates materially. Cooled acoustic antennas-- the Stanford experiment in particular -- have come to perform as expected. Electromagnetically coupled antennas have also progressed, not quite to the limit allowed for by their length. The Munich group has managed to make an interferometer perform to within a factor of 3 of the shot noise limit in a multi-pass system using Herriott delay lines. There

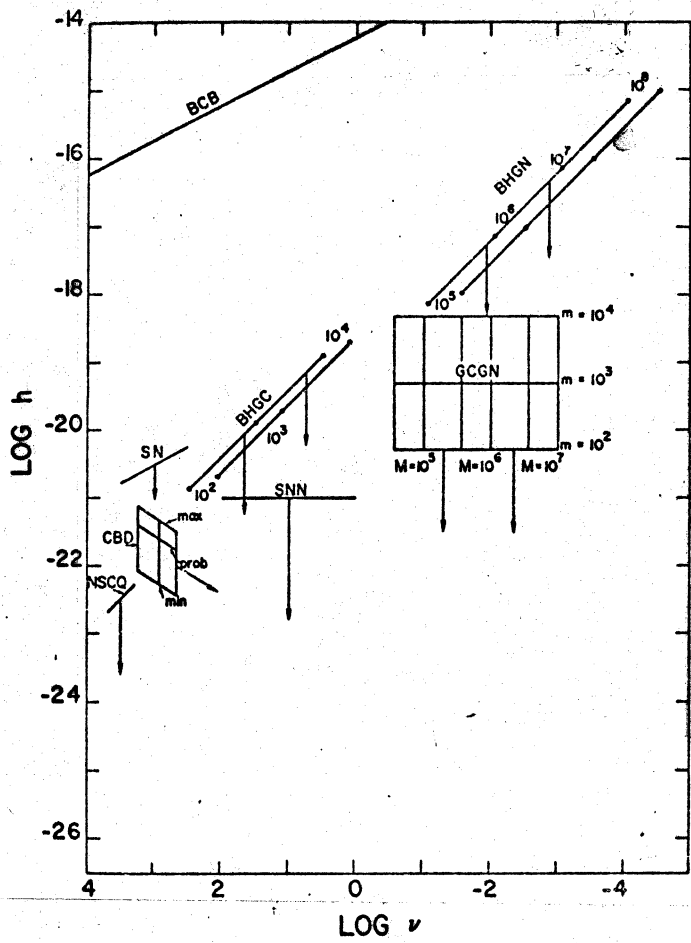

(a)

1a

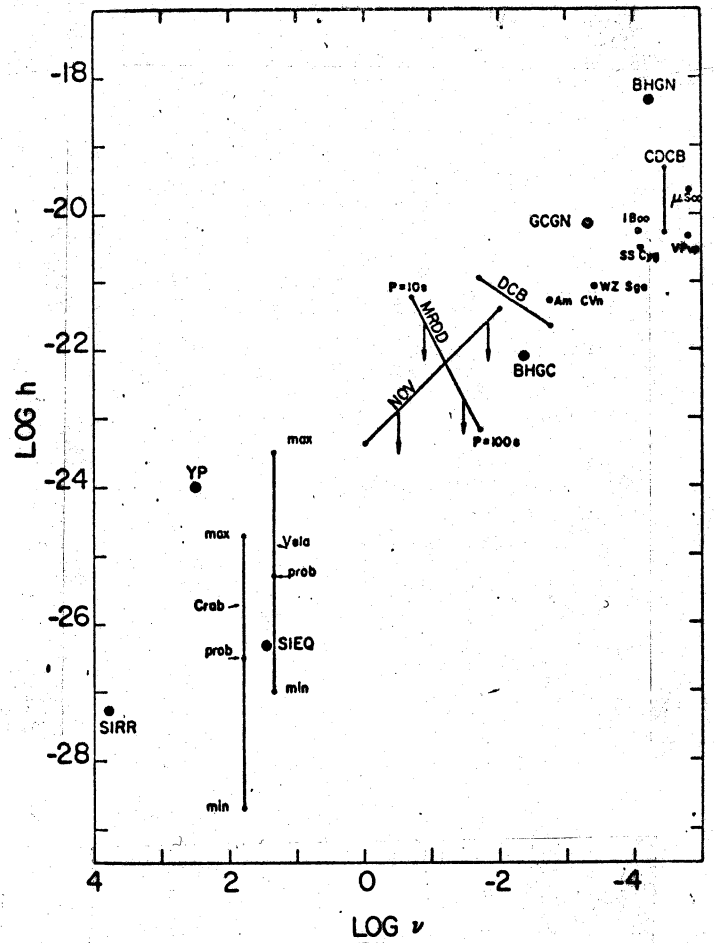

(b)

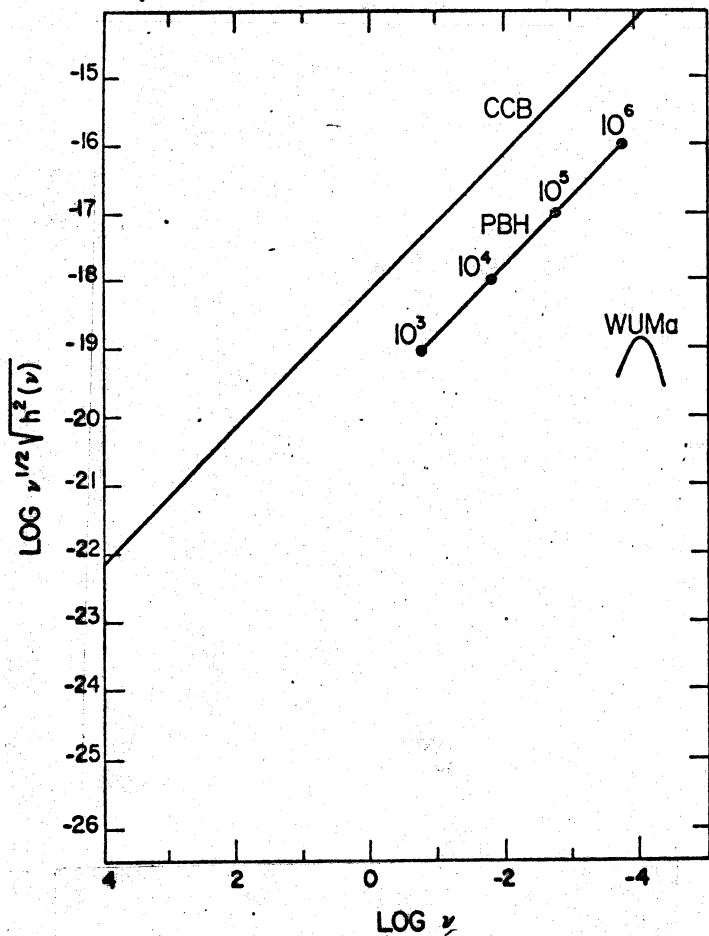

(c)

Figure 1. Amplitude, h , versus frequency, ν , for various astrophysical sources: a) impulsive sources; b) periodic sources, and c) stochastic sources. Some sources of interest are supernova explosions in the Virgo cluster of galaxies, SN, and creation of black holes at the galactic center, BHGC.

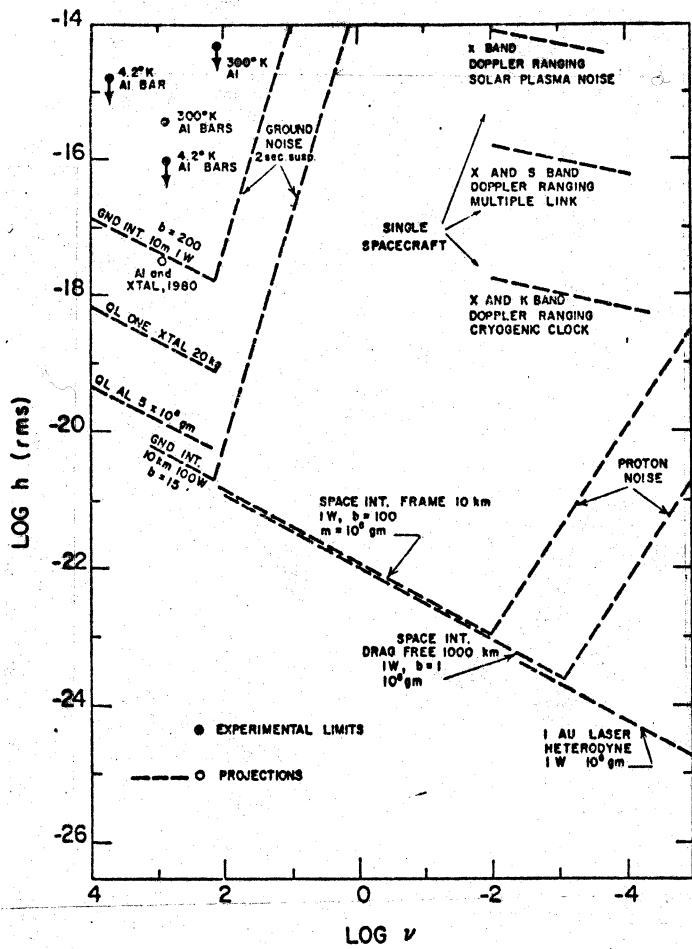

(a)

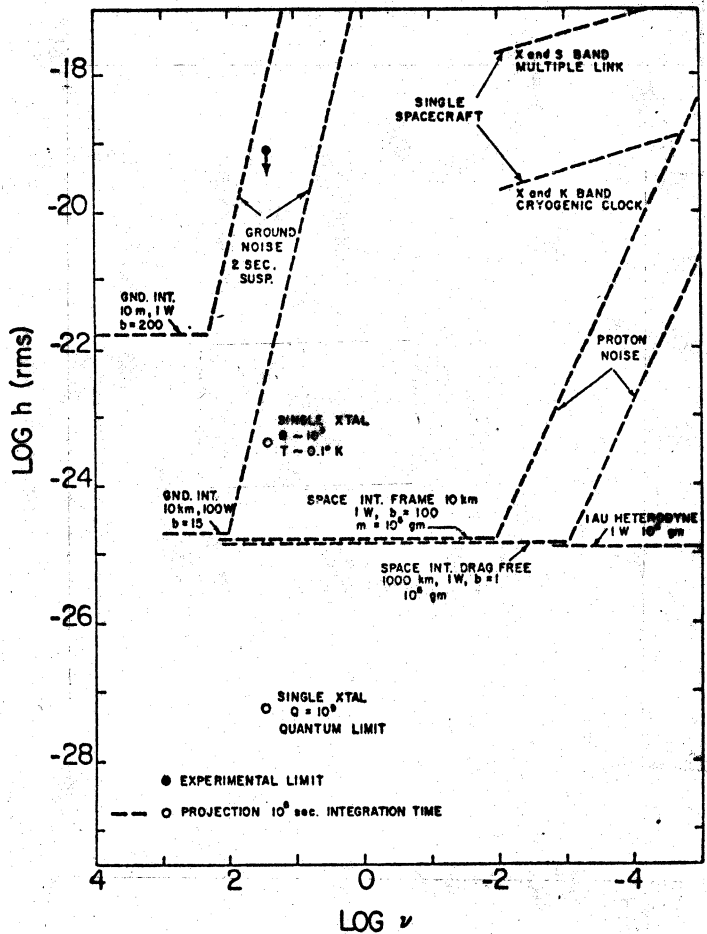

(b)

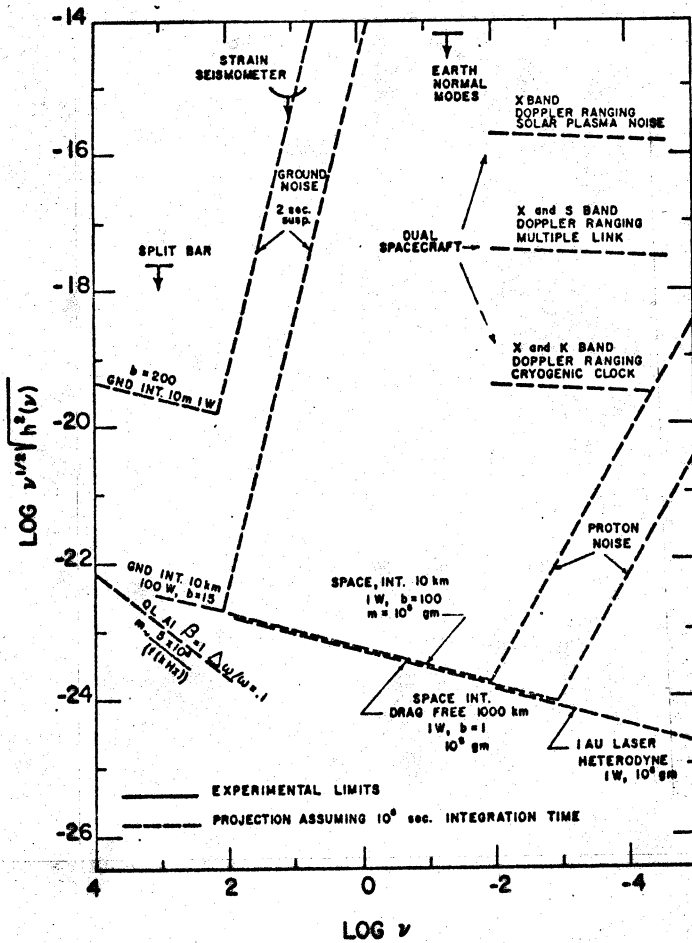

(c)

Figure 2. Projected antenna sensitivity for a) impulsive sources, b) periodic sources, and c) stochastic sources of gravitational radiation.

From: Sources of Gravitational Radiation, L. Smarr, Ed.

have been advances in the understanding of the ultimate limits of these electromagnetically coupled systems through the work of Carlton Caves at Cal Tech. The quantum limit is not a sharp barrier for these antennas at high frequencies. Caves' rigorous calculations support the more heuristic ones carried out beforehand. The optimal optical system, whether it be the multi-pass delay lines (MIT and Munich) or the differential Fabry-Perot (Glasgow and Cal Tech) is not yet determined and, as we will try to show, may not be the important concern in the development of such an antenna designed to measure interesting astrophysical limits. One thing that has changed is the estimate of the ground noise limit, assumed in Fig. 2. This estimate may be too pessimistic, as inertial stabilization schemes can be made and demonstrated that are better than the 1978 projections. Furthermore, the fluctuating terrestrial gravitational gradient also may not impose as hard a limit as previously supposed, if one is clever with the antenna configuration.

The major change at MIT is in the conception of how the project is to proceed. We have come to the realization that it is now time to begin studying the design and construction of a large scale (10 km) interferometric gravity antenna. This study will run parallel to the work on the prototype antenna, and address the engineering and construction problems and costs of a large system. We expect that this study will take roughly three years to complete. If the results of the study are favorable, we would like to begin construction of the large antenna.

The impetus for developing electromagnetically coupled

antennas has always been that they offer the ability to make broadband measurements of the gravitational radiation spectrum, and would be able to measure all three classes of gravitational radiation sources. More important, although not as much work has been done on their demonstration in small prototypes as on the acoustic antennas, the problems that must be solved to achieve interesting sensitivities are primarily ones of scaling rather than of developing fundamentally new and difficult technologies. One can say this in a very bold way. It is now, and has been for several years, entirely in our capability to construct a gravitational wave antenna with an interesting sensitivity, $\Delta l/l \sim 10^{-21}$ at one kHz, if only one was willing to spend the large amount of money involved. There would be no subtlety in such a system, and precious little application of the new technologies that we are working on in the laboratory prototypes at MIT and elsewhere.

We are not proposing the following, but imagine such a system: a square 100 km on a side, constructed of thick wall stainless steel tubing 42" in diameter, including the diagonals. The system is buried 200 meters at its midpoint to accommodate the curvature of the Earth. There are 400 miles of tubing in such a configuration. The tubing is supported every ten meters on servo mounted cradles. The system is evacuated to 10^{-7} mm using 10^5 ion pumps. The system includes 6 interferometers encompassing all pairs of adjacent differences. The optics are single beam interferometers using retroreflectors. All interferometers are servoed to the white light fringe by electrooptic and electrical and mechanical controllers. The light sources

are 60 ion lasers each delivering 20 watts multi-mode. Each interferometer is modulating 100 watts. The tubing is blackened with Martin Marietta black and baffling. Each end station, six in all, has a volume of three cubic meters held at 10^{-8} mm. Each vacuum system is itself supported on a 100 ton 3-dimensional active isolation system. Each end station is internally magnetically shielded to one milligauss by active and passive shields. The data rate is close to 1 megabit/sec to sample to several kHz. In order to correlate the data from the different interferometer arms to make the gravity gradient regression analysis, several multiplications per microsecond are required.

Such a system would have the required sensitivity at 100-1000 Hz; more subtlety, especially in the antenna supports, would be required to stretch the response to lower frequencies. The point made by the above presentation is the following: Look at the requirements individually. They are all within our present technical capability, even in a commercial setting. However, the cost of such an installation ranges between 150 and 200 million dollars, a major U.S. investment in science rivalling medium size space missions and probably too large, considering the limited applicability of such an installation to one branch of science, even though the rationale for such an installation could embrace earth science and other relativity experiments, in fact might even have a military application.

The realization that such a system is possible, but outside the range of economic reality, does color and affect in a deep

way the best strategy for pressing the present effort. If one follows the natural desire to see the field come to fruition in a timely manner, it would drive a commitment to the idea, and suggest a strategy to analyze the individual cost factors and optimize the antenna as a system. This may sound like administrative-ese, but it is in fact the core of this proposal. In plain English, what are the areas to work on to bring the cost of such an installation down by a factor of 10 to 20? This last statement has to be interpreted in a broad sense. There are elements on all levels, some of which will be described shortly. There are strictly handbook-type engineering problems -- optimization of tube wall thickness versus the number of supports, for example. Other classes of problems which one may classify as engineering - experimental problems -- for example, can one get away with standard schedule tubing with the vacuum required, or how does one optimize the number of pumps or the style of pumps. There are subtle engineering problems, with difficult trade-offs -- the complexity of the optical system, for example, whether to use multi-pass or single-pass, versus the tubing diameter and antenna length. And finally, some demonstration experiments of items that could really produce major cost savings, but which have novel and risky engineering solutions.

If one takes a broader view, and looks at the antenna project as an entire system (which we have not done up to now), it will inevitably turn out that the order of priorities of the important demonstration experiments will change. The approach

we have all been taking, of beginning small and demonstrating the performance of small prototype systems to their theoretical limits, may not be sensible. The small systems, of course, have some of the ingredients of the larger system, but their problems may not be the problems of the larger system. A good example is the backscattering problem on the mirrors, which could be a decisive problem in a small interferometer, and of far less consequence in a larger one, whereas the optimization of the optical beam size may very well be the overriding concern in the large system. Another example is the work of superb ground noise isolation systems, which are interesting in their own right, but may be inappropriate if the cost of the isolation system is more than the cost of extending the antenna to achieve the same strain signal to noise.

Our proposal is multi-faceted. Clearly, we will continue with the development and analysis of our 1.5 meter prototype system in the laboratory. Too much time has been invested in it not to see it to completion. There is still much to be learned from it, particularly to show where the noise modeling works and where it fails. Furthermore, it is also extremely satisfying to have a piece of equipment to try ideas on. We will continue to expand our research into active isolation stages, which are both showing promise and will be important in any larger installation. We will not strive to build an intermediate antenna. This is being carried out at Glasgow and Cal Tech, and possibly in Munich. On the other hand, we do propose to begin, in a concerted way, the engineering study of a larger system, with the in-

tent to build such a system. We are interested in getting a real understanding of the cost trade-offs, and where necessary, as driven by the study, to carry out side and pilot experiments on technically relevant cost-savings items. A systems study cannot be carried out by our group alone, nor would it be appropriate. We therefore propose to subcontract some of the work to industry, even at this early phase.

In preparation for this, we have begun informal negotiations with the scientific and engineering consulting firm of Arthur D. Little in Cambridge, MA, and with the engineering firm of Stone & Webster in Boston. We presented both companies with an outline of the experiment, using a 10 km version of the antenna as an example for discussion. The preliminary mechanism of the interaction is that we propose, for heuristic purposes, a specific set of problems which we have identified within the framework of an example design described by us. Such a study must focus on a strawman design based on our initial instincts of what is needed. These preconceptions are bound to change in the course of the study. We hope to maintain flexibility by establishing cost scaling laws at each technical branchpoint. However, to get anything meaningful from such a study, we must begin with a specific example.

We have categorized the study in the following manner:

Configuration Study - Within the constraint that the longest path be 10 km, what is the optimal geometry to permit regression of local time varying gravity gradients, as well as to be sensitive to both polarizations of the gravitational radiation field? This study encompasses estimates of the gravity gradient noise

spectral density due to atmospheric density fluctuations, water table fluctuations, gravity gradient noise from longitudinal seismic disturbances, incidental noise from birds, airplanes, and other anthropogenic sources, the gravity gradient signals of low flying satellites, and possibly the military application of detecting these. This study is best done by MIT directly; however, a member of the A.D. Little group has shown interest in this as well.

Site Selection - Considerations are the seismicity of the site, in particular the existence of local shear, the availability of the land, environmental impact, corrosion caused by the specific location, and most important, the ease of working with the terrain for trenching or framing, and the proximity to sources of supply for developing the site. Again, to prevent the study from being too open-ended, specific suggestions of available sites are to be studied first. Land around the Sandia Corporation of Albuquerque, New Mexico, both in Albuquerque, as well as a plot in Nevada, now abandoned, but developed by Sandia for the Nuclear Weapons Testing Program, will be considered. The connection to Sandia is worth cultivating, as there is an active geophysical research group there who, in the early 1970's, assembled a 1.6 km long laser strain seismometer patterned after the design of Jon Berger of the University of California at San Diego. Incidentally, this installation cost \$100,000. The other site to explore is in the Plain of St. Augustin, at the location of the Very Large Array (VLA). Both A.D. Little and Stone & Webster would be interested in pressing such a study.

Professor Nafi Toksoz, of the Earth and Planetary Sciences Department at MIT, will join us in the study of site selection and configuration. His interest in the study lies in its potential application as a means of measuring two-dimensional earth strain over large enough base lines to sample non-local structural deformations, especially as they relate to tectonic activity. Large laser interferometers are probably not competitive with the promise of VLBI in measuring tectonic plate movement on the scale of thousands of kilometers. However, VLBI most likely will not measure on the 10-100 km scale, and furthermore, a large laser system can go part of the way to act as groundproof for the VLBI measurements.

The remaining categories are not orthogonal, but indeed, highly interactive, in both an engineering sense and in their effect on cost optimization.

Optics - The optical design is one of the most difficult aspects of the engineering problem, and consequently the one most likely to benefit from ingenuity. It is clear there are many trade-offs in the optics; ingredients in the formulation of the problem are: available light power, the degree of multipass, pointing precision, beam diameter, light storage time, and the gravitational frequency response of the antenna, to mention a few. There is, however, an overriding principle. The optics plays the role of the differential displacement transducer in these antennas. When the transducer noise matches the other noise sources in the system -- the stochastic noise forces on

the antenna end points -- there is clearly no point in making the transducer better until the local noise sources can be reduced further. The major attribute of the electromagnetically coupled antenna lies in the fact that they can be extended to lengths close to the gravitational wavelength. Many of the stochastic forces are due to local phenomena -- the ground noise, thermal noise, electric and magnetic forces -- which do not grow with length. If these were the only noise terms, one would achieve a linear increase in amplitude signal to noise for gravity detection with length. There are noise terms that grow with the length. The two we have identified are: (1) Propagation noise, index fluctuation in the vacuum, which should scale as $\ell^{1/2}$, but could be made negligible with a sufficiently good vacuum, 10^{-6} mm Hg in a 10 km length. (2) Time dependent gravity gradient noise, which in a naive calculation grows linearly with the length. However, depending on its power spectrum and origin, the local gravity gradient noise could be discriminated from the gravitational radiation from distant sources by using the local time varying gravitational potential's third derivatives. This aspect of the antenna design (already mentioned under Configuration) is one of the more interesting scientific-technical studies proposed, and may have more impact on the design and configuration of a large antenna system than any other, as it affects the low frequency performance of the system.

The rationale for having written the above paragraph, much of which is already known by all who have been working in this area, highlights the fact that the optical design cannot be viewed

in isolation from the rest of the system. The fact that we, or any other group, may demonstrate shot noise limited performance in a specific configuration certainly adds credibility to the antenna concept, but may not be the overriding concern in the practical antenna. As a hypothetical example, suppose it turns out that the only way to beat the stochastic noise forces is to make large structures. Then much of the effort now expended by all of us to make multi-pass systems, with their very special problems, work, may be misdirected. What we should be working on are refined beam steering techniques, feedback techniques to keep the tubes straight, and beam diameter minimization.

As the basis of the optical study, we are considering the following options: Multi-pass reentrant delay lines, non-reentrant delay lines (corners and beam translation) to the limit of a single beam, and Fabry-Perot cavities. We will not study fiber optics, or adaptive optics, which some have suggested to us as a technique to eliminate the need for the evacuated light paths.

At the outset, one already knows some of the advantages and limitations of these designs. The multi-pass delay lines may experience difficulty with multiple backscattering of the beam, first analyzed by Ron Drever. The temporal separation of the beams grows with antenna length, and this problem, if it exists, becomes more easily soluble by light beam frequency and phase modulation at some expense in duty cycle. Another more serious difficulty with multi-pass delay lines of both reentrant and non-reentrant type is that the tube diameter is not minimized. A Gaussian beam is the minimum width beam possible.

It scales in maximum diameter at $1/e$ as $(8\lambda L/\pi)^{1/2}$, for example, 4.5" in a 10 km length, for a wavelength $\lambda = 5145\text{\AA}$. Since the delay line multi-pass systems rely on spatial separation of the beams, the total envelope dimension must scale at least as the square root of the number of beams. For a 10 km system, with ten beams, the tubing diameter must then be larger, by a factor of 3-4, than for a single beam. The delay lines do have the significant attribute that their properties are independent of wavelength, which permits their use with frequency unstabilized high power laser sources, when operated in an interferometer near the white light fringe.

The Fabry-Perot cavity has the advantage of having the minimum beam diameter, and probably less difficulty with mirror scattering, important in small length, high finesse systems. It imposes a constraint on the frequency width of the light source, and therefore on the maximum useable power.

Problems associated with precision beam steering, laser angular jitter, and the effects of beam apodization by the tubes are common to all the optical schemes. In thinking about these problems, several side experiments are suggested. An experimental study of the phase shift of a Gaussian beam on axis, when apodized by absorbing and baffled tubes at the beam edge, must be undertaken. Another feasibility experiment would be the engineering implementation of an active deformable mirror to steer and mode-match a light beam into a long light path. The mirrors used in the large structures would be virtually flat. Their

slight curvature and the directions of their normals would have to be under servo control by beam monitors stationed along the path, or at the ends.

An unattractive option, due to its complexity, but one that must be considered, as it may lead to a substantial cost saving if tubing diameter is the real cost driver, is the use of internal relay optics. The tube diameter would scale inversely as the square root of the number of internal elements for a fixed beam length. It is important to evaluate the headaches associated with alignment and the new sources of acoustic and seismic coupling, as well as losses in the optics, which may yet prove to outweigh the cost savings in tubing.

Another problem closely related to the optical configuration is the present availability of commercial high power visible lasers. At present, the most powerful optical lasers are the rare gas ion lasers manufactured by **Spectra Physics and Coherent Radiation**. They develop on the order of 20 watts multi-line and several watts in a single line (Argon 5145Å, approximately 3 watts). Several years ago, the possibility of isotope separation using visible lasers drove a development in the industry toward more powerful lasers. At this time, due to technology shifts in the isotope separation program, this development program has ended.

There is no fundamental scientific challenge in constructing more powerful argon lasers. Rumor has it that the Russians at Novo Sibirsk have assembled a 500 watt laser. But there are substantial manufacturing and engineering problems. Spectra Physics

marketed a 40 watt laser by using the expedient of putting two of their 20 watt lasers in series. It did not turn out to be a very successful product. To get more powerful lasers will require redesign of the plasma tubes to achieve both higher total current as well as a larger current density. There are designs for such tubes, but no commercial applications to drive the development. At present, if one wants to have 100 watts of visible cw laser power, the only way is to use lasers in parallel (PL has suggested this), or to develop the technology of a high power laser in a university or government laboratory. We are not privy to military developments. The choice of moving to longer wavelengths, in particular $10\ \mu\text{m}$, the operating wavelength of the CO_2 laser, could be considered, but we will not do this in the initial study.

Arthur D. Little has shown interest in carrying out engineering studies of some of the optical problems. At MIT, a great deal of the time in the next year will be devoted to these. We will be joined by Professor Shaoul Ezekiel of the Electrical Engineering Department and the Aeronautical Engineering Department at MIT in this aspect of the project. He has a scientific interest of his own in the large structures as a means of developing a Sagnac interferometer system (passive laser gyro) for studies of torsional earth motion, and the preferred frame tests that could be performed with meaningful sensitivities in structures of the size envisaged.

Seismic and Acoustic Isolation - The design and testing of seismic and acoustic isolation systems fall squarely in the category of subtle engineering problems. At present, there exist no commercially available isolation systems that match the requirements of a broadband electromagnetically coupled gravitational antenna operating at astrophysically interesting sensitivities. It is possible, as has been demonstrated in the research on acoustic antennas, to isolate ground and acoustic noise to acceptable limits at frequencies above several hundred Hertz in a narrow band. This has been done with passive mechanical filters in a completely analogous way to the design of electrical filters using lumped circuit elements guided by well known filter synthesis theory. The same techniques could be applied to the supports of an electromagnetically coupled antenna if all that were desired were gravity wave detection in a narrow frequency band. The promise of these antennas, however, lies in their broadbandwidth and potential in detecting low frequency ($f < 100$ Hz) gravitational radiation. To make good on this promise poses a challenge in the design of isolation systems.

The approach we have taken is to use active isolation by incorporating a seismic reference element in a closed servo loop. The technique, described in Appendix 1, is quite successful, as demonstrated in a one-dimensional system. Work on these systems will continue at MIT in the next year to extend the concept to three dimensions, as well as to improve the isolation to its theoretical limits determined by the seismic reference element noise.

Construction Strategy - The optical and vibration isolation systems are decisive in the design; however, they must be considered in context with other elements which fit broadly in the category of construction strategy. Among these are the choice of tubing, tubing installation and support, alignment, thermal control, and vacuum. These elements are highly interactive in a cost trade-off analysis.

Although no system has ever been constructed that is exactly like a large electromagnetically coupled antenna, there is experience with some of the aspects of this construction in other projects. ~~The following are examples.~~ Construction techniques and maintenance procedures for long lines of tubing have been developed by the gas utilities. Some of the problems in thermal control and alignment of long tubes have been studied and solved in the construction of the microwave waveguide linking antennas of the VLA. Alignment and vacuum specifications comparable to or better than those needed in a large electromagnetically coupled antenna are encountered in linear particle accelerators. It would serve the study well to begin by using these examples, where appropriate, as a baseline for establishing and scaling costs.

The experiences of the gas utility companies is both interesting and useful, as it uncovers cost factors we might not have thought of. The gas companies use standard schedule carbon tubing ranging in diameter from 42" in major lines to 10" in branch lines. The tubing has to sustain a gas pressure of 1000 psi. The tubing is coated to prevent corrosion, joined by arc

welding, and buried in trenches so as to allow 30" of back-fill. The tubing is supported by sand, and occasionally by gravel, if drainage is needed. The design lifetime of the gaslines is 30 years. A typical total cost of laying 24" diameter pipe is \$450,000 per mile. The tubing cost is approximately one-third of the total, the trenching, welding and back-filling costs are approximately one-half. The remaining costs are in surveying, coating, testing, and inspection. A typical overall construction rate is a mile per day.

Gas lines are not high vacuum systems, nor do they need to be aligned to a one-tenth of a second of arc over 10 km, as would be required in an antenna, but many of the procedures used in their construction might be needed. For example, burying tubing may be the most economical method of maintaining thermal control, although framing above the ground should be considered if it offers a substantial cost saving, despite the fact that the daily and seasonal temperature variations on thermally unshielded tubes are large, and one runs the risk of more buckling, and especially time dependent outgassing of the tubes. A virtue of framing is accessibility to the tubes.

The experience at the VLA has bearing on alignment and stability of alignment. The spinal column of the VLA is a 6 cm cylindrical pressurized waveguide operated at carrier frequencies ranging from 20 to 50 GHz. The waveguide, oversize to reduce transmission loss, has an internal structure of wires to suppress waveguide modes other than those desired. The guide, enclosed in a mild steel tube, is buried at an average depth of 1.5 meters.

along the three 20 km legs of the VLA. The waveguide is used both to transmit information from any of the antennas to a central location, as well as to send timing information to the antennas to synchronize the local oscillators. The entire system is therefore "surveying" continuously by this timing information to an accuracy of $\frac{1}{2}$ cm over 20 km, with direct validation of the "survey" by observation of point sources.

The present experience at the VLA is that they measure phase shifts in the system with a daily period equivalent to 10 cm over 20 km, the major part of these being due to thermal fluctuations of the transmission lines and couplings that lie above the ground. The fluctuating phase shifts due to the buried waveguide alone are thought to be less than 4 cm. One of the interesting results is that no large secular changes have been detected, indicating little if any earth shear and settling. The construction of the waveguide lines cost \$160,000 per mile, the bulk of the cost being in the waveguide itself.

The vacuum system associated with both the MIT (Bates) Linac and the Stanford linear accelerator (SLAC) are clearly prototypes of those needed for the gravity antenna, albeit that they may be too costly. The MIT Bates Linac maintains pressures less than 1×10^{-6} mm of mercury in a 700' long 8" diameter stainless steel tube. The system employs titanium evapor ion pumps which operate without maintenance (no cryogenics, in particular) for years, providing there is no large gas load on the system. In order to bring the ion pumps into their operating region, prepumping of the system to 10^{-3} mm by other means is required. The SLAC installation though different in scale and

required.

The SLAC installation uses 4" diameter OFHC copper tubing in a central high vacuum chamber maintained by ion pumps. The copper tube, which serves as the waveguide and beam tube, is surrounded by a second chamber with higher pressure. SLAC is 2 miles long; nevertheless, it is regularly aligned to 1 mil in 2 miles, an angle of 1/1000 of a second of arc.

Stainless steel tubing and ion pumping have become the standard methods of obtaining high vacuum in gas stationary systems. Stainless steel tubing has many advantages -- its resistance to corrosion, relative ease and reliability of inert gas welding, and good outgassing properties -- but it is expensive. It is incumbent on a study of a large antenna to investigate the problems associated with using less expensive tubing -- aluminum tubing of all types, drawn, extruded, port-hold died, and also standard schedule steel tubing, especially as regards its vacuum properties, which are bound to be worse than stainless steel, but which could be compensated for by an increased pumping speed of the vacuum system.

Both A.D. Little and Stone & Webster are interested in working on parts of these construction strategy problems.

Data Handling and Analysis - Experience in planning NASA space missions (RW) and carrying out high energy physics experiments (PL) has taught that considerable installation and recurrent costs are involved with data analysis and handling in a large project. Clearly, these costs should be included in a study of the style proposed. It is also important to begin

evolving the data analysis and handling strategy in the early planning, as it can strongly influence the design of the experiment, especially in the configuration study.

In the gravity antenna project, there are three levels of data analysis and manipulation, broadly classified as control, regression, and signal analysis. The control function embraces processes as primitive as monitoring of antenna house-keeping information and putting it into a formatted data stream for storage, to processes as subtle as computer (microprocessor) control of the interferometer alignment. The regression function relates to the correlation of the many parameters that are measured simultaneously in the antenna. Their analysis poses a significant computing effort. The output signal of an individual interferometer will contain noise of three sorts: that which is not correlated with any other measured variable, for example, thermal noise at the antenna endpoints; noise terms that are correlated with independently measured variables -- ground noise, laser intensity fluctuations, for example; and finally, noise terms that are correlated between separate interferometer outputs, such as the local gravity gradient noise, as well as the gravity radiation signal. Algorithms have to be invented to perform the regression function, which then produces a "cleaned" signal for the final signal analysis. Efficient digital techniques have to be developed for this last stage of the analysis, to establish criteria for pulse detection in the broadband outputs, as well as to search for periodicities.

Up to now, we have neglected this aspect of the experiment, even in our development of the prototype antenna. We hope to redress this, as discussed under the heading Computer. Furthermore, the project has the good fortune of having attracted Professor E. Wright of the MIT Physics Department, who is both interested in the astrophysics that could ultimately be uncovered by gravitational astronomy, but more to the immediate point, is proficient in data analysis and the application of digital techniques to experiments. He has expressed interest in the data analysis part of the study.

RESEARCH PLAN AND BUDGET NARRATIVE

We are proposing an ambitious research program but one we believe to be necessary if the search for gravitational radiation from astrophysical sources is to come to fruition. We are committed to finishing the development of the prototype antenna, as there is much to learn from it, but it is now also time to see where we are headed. Our intuition is that it is possible to construct an antenna which will yield astrophysically interesting information. The increased optimism for the success and scientific value of a large gravitational wave antenna, as well as its possible applications to other scientific disciplines, has drawn new people into the project at MIT.

Approximately 2/3 of the proposed first year budget (and effort) is involved with: completing the prototype antenna, measuring its noise performance, the development of an active isolation system, and side experiments on the optics. This effort involves Weiss, Linsay, Shoemaker, Benford, an electronics technician, and two graduate students -- one student on the prototype antenna project, another on the development of isolation stages. This effort also includes all the equipment and materials and services budget.

The study of a large antenna system uses the remaining 1/3 of the first year budget. A possible plan for the study is schematized on the accompanying figure (p. 25a). In the first year the bulk of the effort, leading to the first conceptual design of a large antenna, will be carried out at MIT. Linsay will spend 1/2 time organizing and administering the study. To help in the study, we intend to fill a post-doctoral position with a physicist interested in the large antenna system. (Several qualified

candidates have expressed a desire to work on this project.) Although the MIT group will work in concert, we will divide initial responsibilities in the following way. The post-doctoral scientist and Weiss will work on the optimal antenna configuration and the suppression of gravity gradient and seismic noise. Linsay and Wright will work on experiment design and the data analysis strategy. Ezekiel will study the optical design.

We will need help in the engineering, construction and cost aspects of the study in all of the three years. It is not realistic to look for this in the academic engineering departments of MIT as the engineering faculty carry out research of their own interest which does not necessarily intersect with our needs. Therefore we are going to outside commercial engineering firms to buy this help. We have chosen to consult with the engineering and consulting firm of Arthur D. Little Corporation, Cambridge, Mass and the engineering firm of Stone and Webster, Boston, Mass. Letters of intent from both of these companies as well as resumes of the staff they intend to make available to the study are attached at the end of this proposal.

Arthur D. Little has considerable engineering experience in optical, vacuum and thermal design. RW has had good experience with this company in thermal design studies of the COBE satellite project.

Stone and Webster is an engineering company primarily involved with large scale construction in the power industry; fossil as well as nuclear fuelled installations. Stone and Webster has close associations with MIT and views the gravity antenna project as means of maintaining these connections as well as enhancing corporate prestige. The antenna study, indeed even the construction of a large antenna were it to come about,

would be of little financial consequence to this company. Stone and Webster would be involved in making trade off and parametric optimization studies of the conceptual design evolved by MIT and Arthur D. Little. They would also make the cost estimate of the final iteration of the conceptual design. Stone and Webster and MIT would produce the study report.

During the first year the focus of the study, is at MIT, nevertheless we would like to have use of the resources of both of these companies in a truly consulting mode, even though they will not have been assigned specific tasks. Furthermore, it is wise to get their advice as the initial conceptual design becomes formulated.

In the second year of the proposal, the emphasis and the larger fraction of the budget shift toward the study. The laboratory effort will become involved with specific engineering experiments suggested by the optical and mechanical design of the first phase of the study of the large antenna. We intend in this year to enhance our computing capability to develop modelling and data analysis algorithms for a large antenna (see section on computers).

In the second year of the study Arthur D. Little will be given specific tasks to analyze the optical, mechanical, and vacuum design while all three groups, Stone and Webster, Arthur D. Little, and MIT will carry out trade off and parametric optimization studies together.

In the third year of the proposal we anticipate that the laboratory work started in the second year will continue. We would like to augment it by studies of the noise properties of high power lasers. During this

year the final iteration of the conceptual design of the large antenna and its cost estimate will be made.

The study results will be public information; however, they are most likely not publishable in the standard journals. The study could be an incidental publication of the MIT Press, or an NSF disseminated document. We hope the study will be the basis for the formation of an NSF sponsored Science Steering Group for Gravitational Astronomy, composed of all interested parties, as, if such a large project becomes a reality, it will require the support and wisdom of the entire community.

DURATION IN MONTHS

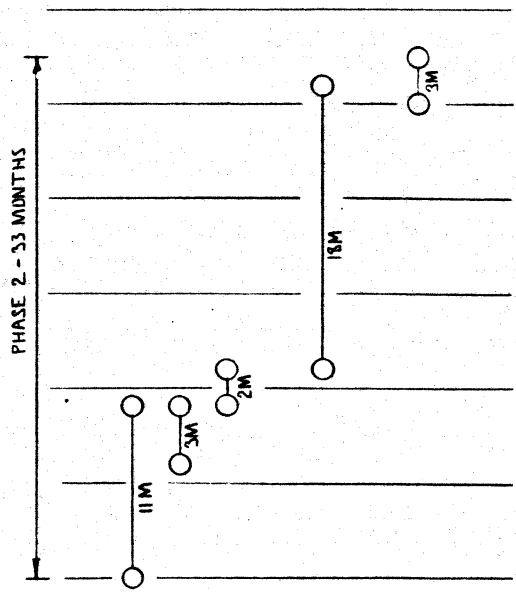
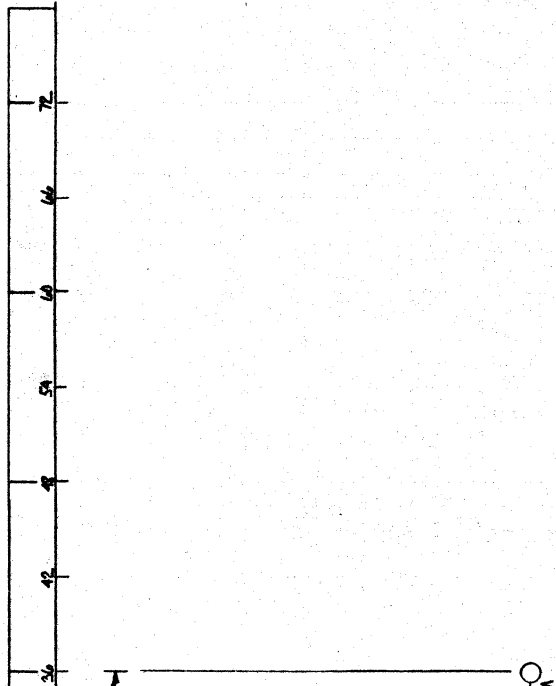

TASK	DESCRIPTION	RESPONSIBILITY
PHASE 1		
TASK 1	REQUIREMENTS DEFINITION	MIT
1A	DESIGN REQS	MIT
1B	OPERATIONAL REQS	MIT
TASK 2	CONCEPTUAL DESIGN	
2A	TRADE-OFF STUDIES	MIT/ADL/S/W
2B	PARAMETRIC OPTIMIZATION STUDIES	MIT/ADL/S/W
2C	CONCEPTUAL DESIGN DRAWINGS	S/W
2D	CONCEPTUAL ESTIMATE	S/W
TASK 3	PHASE 1 STUDY REPORT	MIT/S/W
PHASE 2		
TASK 4	FINAL DESIGN	
4A	DETAIL DESIGN	MIT/ADL/S/W
4B	DETAIL DESIGN ESTIMATE	S/W
4C	DETAIL DESIGN REPORT	MIT/ADL/S/W
TASK 5	CONSTRUCTION	S/W
TASK 6	START UP & TESTING	MIT/S/W

LEGEND:
 MIT - MASS. INSTITUTE OF TECH.
 ADL - ARTHUR D. LITTLE
 S/W - STONE & WEBSTER

GRAVITY WAVE ANTENNA MILESTONE SCHEDULE			
ISSUE	1	2	3
PREP			
REVIEW			
APP			
DATE	3-26-81		

STONE & WEBSTER ENGINEERING CORPORATION
 W.O. NO. 528.382.1

A B C D E F G H I J K L M N O P Q R S T U V

COMPUTER

At present our laboratory owns a PDP-11/20 computer bought in 1972. This computer has served in performing data analysis, on line experiment control and the small scale calculations involved in experiment design and modelling. The computer, now outdated, has become troublesome and is no longer serviced by the manufacturer so that we spend an increasing amount of our own time in repairing it. More important, the computer is inadequate to handle the data rate of the prototype antenna as well as the design modelling and development of data analysis algorithms we anticipate in planning the large antenna. It is clear to us that we have to upgrade our computer capability in the very near future.

The problem posed by the rapid development of computer hardware is how best to anticipate obsolescence? An approach which seems to be sensible is to rely on several small computers such as an LSI-11 to service and control sub systems as well as to format and prepare data for a central control computer. The control computer, having sufficient storage and speed, is then used in total experiment control and to perform the final data manipulations such as regression, correlation and spectral analysis. A strategy like this will certainly be needed in a large antenna system.

We would like to purchase an LSI-11 this year to gain experience with it as a sub system control computer on the prototype antenna. In the following year we intend to buy a larger computer, a VAX-11/750, which will be jointly funded by NASA for use on the COBE (Cosmic Background Explorer) Project and this NSF Proposal. We believe that a VAX-11/750 would be a better choice of computer for large processor than a PDP-11/60, despite its extra cost of roughly \$30,000. The principle reason is that the VAX series will probably

replace the large PDP-11 computers over the next ten years. In addition, the 750 is two to three times faster in execution than an 11/60, and is capable of expanding memory to two million bytes of core, ten times what is available on an 11/60.

PROGRESS DURING 1980

During the past year we have concentrated on finishing the construction of the interferometer. The two main tasks, now nearly complete, have been modification of the vacuum system and low noise damping of the free masses.

In order to permit changes in the alignment of the interferometer while it is under vacuum, we have added an XYZ θ manipulator to the pendulum support of each mass. Each manipulator is made up of three orthogonally mounted micrometer driven translation stages and a screw controlled rotation stage. A pair of vacuum bellows provide the coupling from each XYZ θ stage to the pendulum support in vacuum. Additional changes to the vacuum system were also made in order to simplify the electrical connections and the final assembly of the apparatus. These components are all complete and the vacuum system is now being leak tested and reassembled.

The main effort of the past year has been to build an electronic servo-system to provide low noise damping of the free masses. Without this feedback system to damp the motion induced by the ground noise, the mirror motion would be so large that it would be impossible to hold the interferometer locked on a single interference fringe. A block diagram of the servo loop is shown in Fig. 3. Seismic noise enters the system through the pendulum point of support. The motion is sensed by a capacitive bridge, which generates a signal that is fed back to the free mass through a damping capacitor. The low pass filter generates the correct transfer function to critically damp the motion of

the mass. The overall effect of the servo loop is to electronically lock the mass to the table at low frequencies while allowing the mass to be free at high frequencies.

A block diagram of the bridge circuit and low pass filter is shown in Fig. 4. The bridge was designed to operate at RF because of the availability of very quiet electronics at these frequencies. The bridge amplifiers have an equivalent input noise at the bridge of 1.5nV/Hz. The circuits are assembled on printed circuit boards like that shown in Fig. 5. The sensing and damping capacitors (Fig. 6) are made of copper evaporated onto glass plates. Two sets of capacitors are mounted on each plate, in order to damp rotation about one axis, as well as damping the corresponding translational motion. If needed, we will be able to damp all six degrees of freedom of each mass.

The calculated spectral noise density of a mass (Fig. 7) indicates that we will be able to achieve the laser shot noise limit at frequencies above roughly 600 Hz. This limit is due to the electronic noise in the amplifiers driving the masses. The ultimate performance of the system is determined by the local seismic noise, which in the present set-up would not allow us to reach the shot noise limit below 300 Hz. The inertial response of a mass ($X_m(t)$, Fig. 8) to an impulsive force is heavily damped and is essentially gone after two seconds. The output of the bridge ($V_o(t)$, Fig. 8), which is approximately proportional to the acceleration of the mass, also decays with the same time constants. The time constants in the feedback loop were chosen to minimize the rms inertial motion of the mass rather than to

achieve the fastest damping.

A third effort we have carried out this year has been to build an amplitude stabilizer for the laser light. The current scheme is a simple dc feedback loop, using a Pockels cell to modulate the beam (Fig. 9). If better performance is needed, we will build an RF loop, using the low noise circuits we have developed for the damping servo system.

A fourth effort during the past year has been the development of active seismic isolation systems. This is described in Appendix I. ←

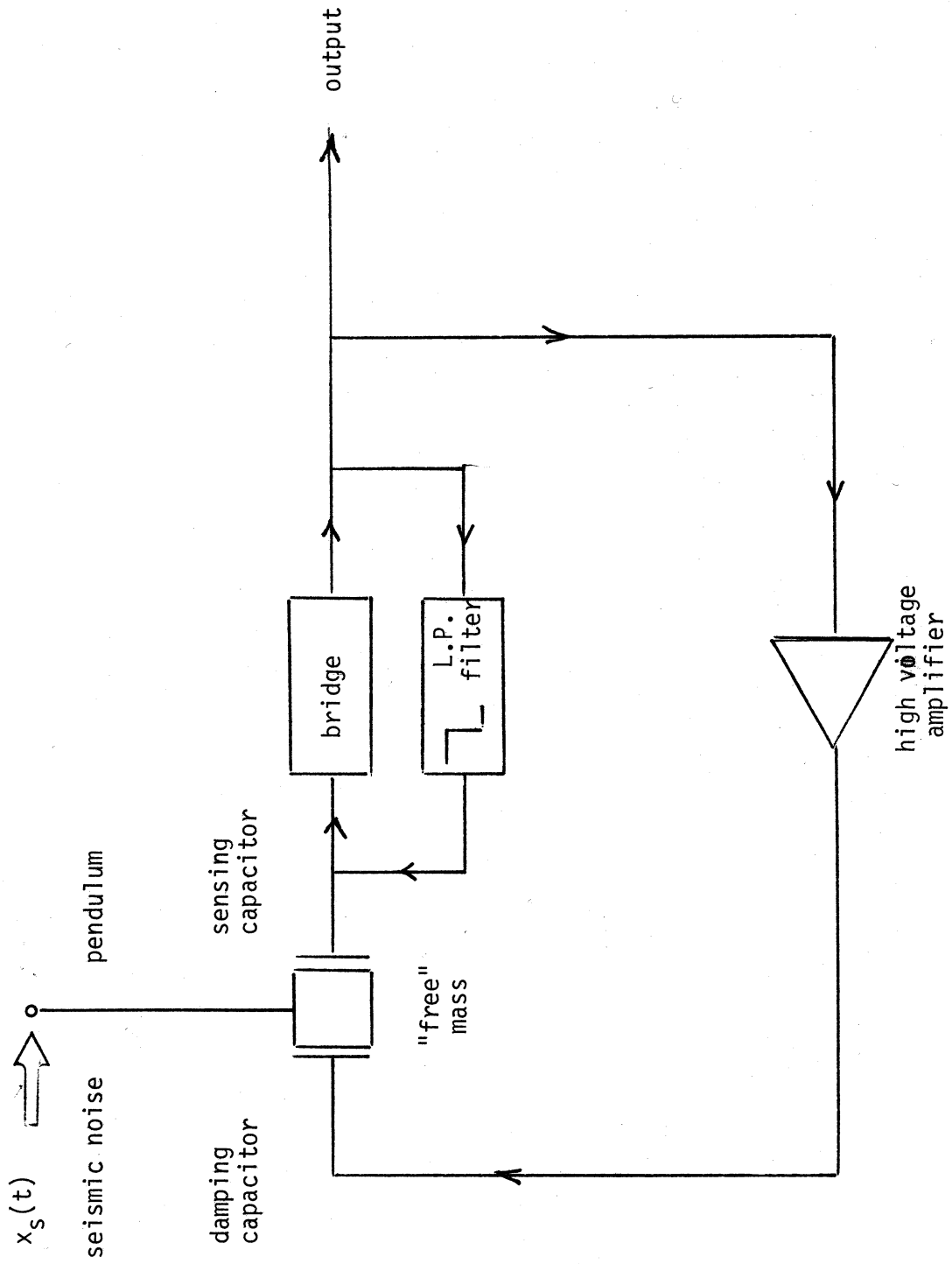

FIG. 3

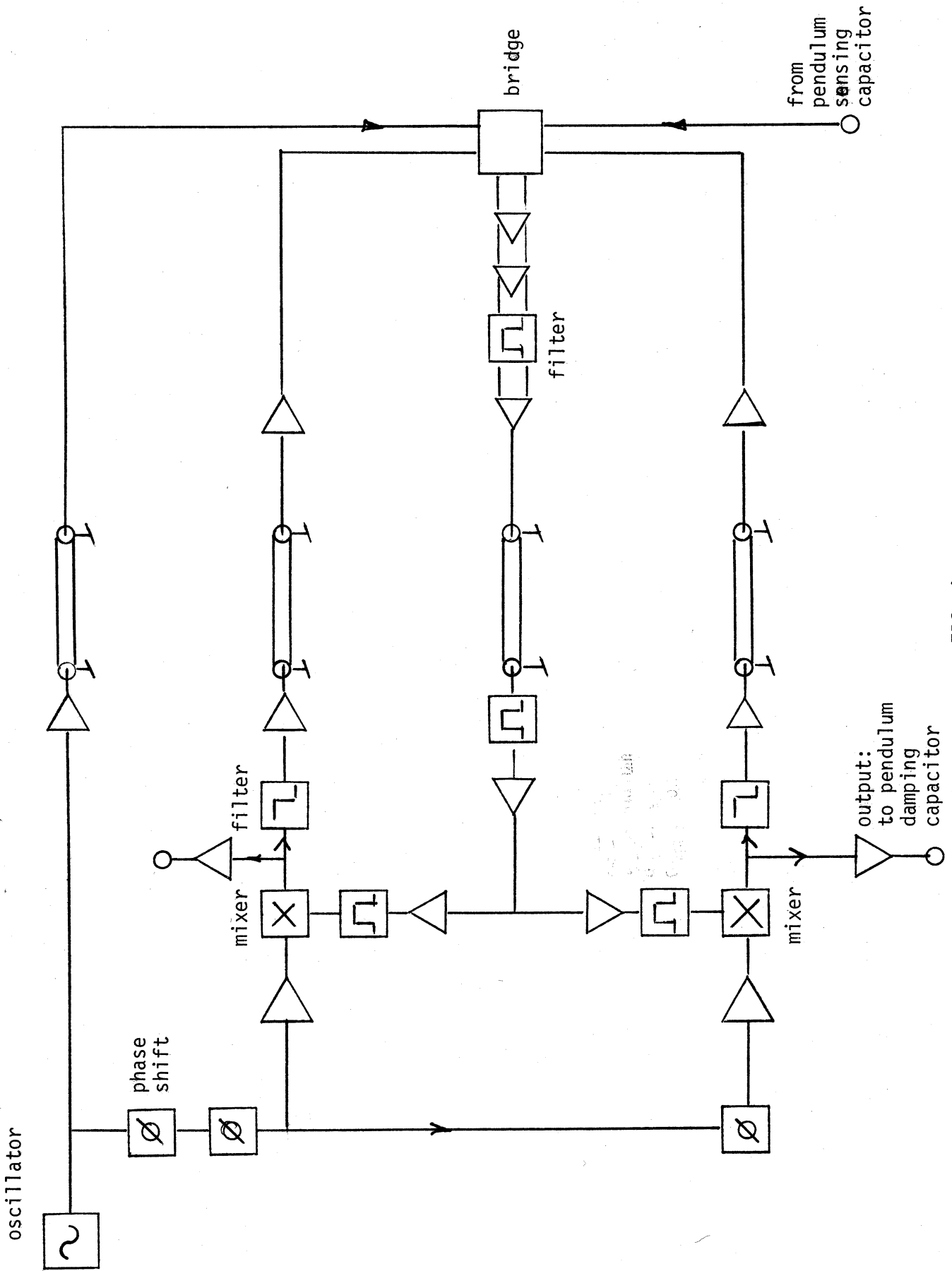

FIG. 4

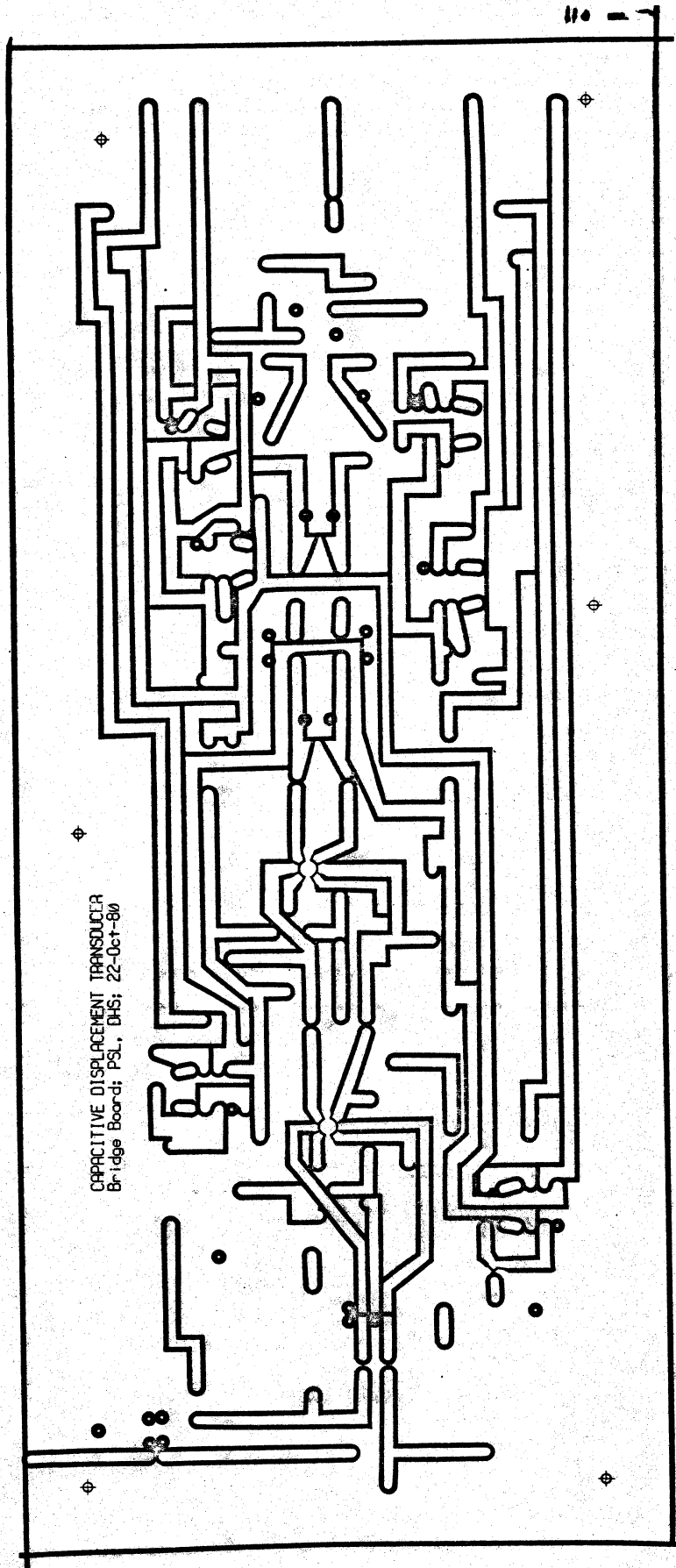

FIG. 5

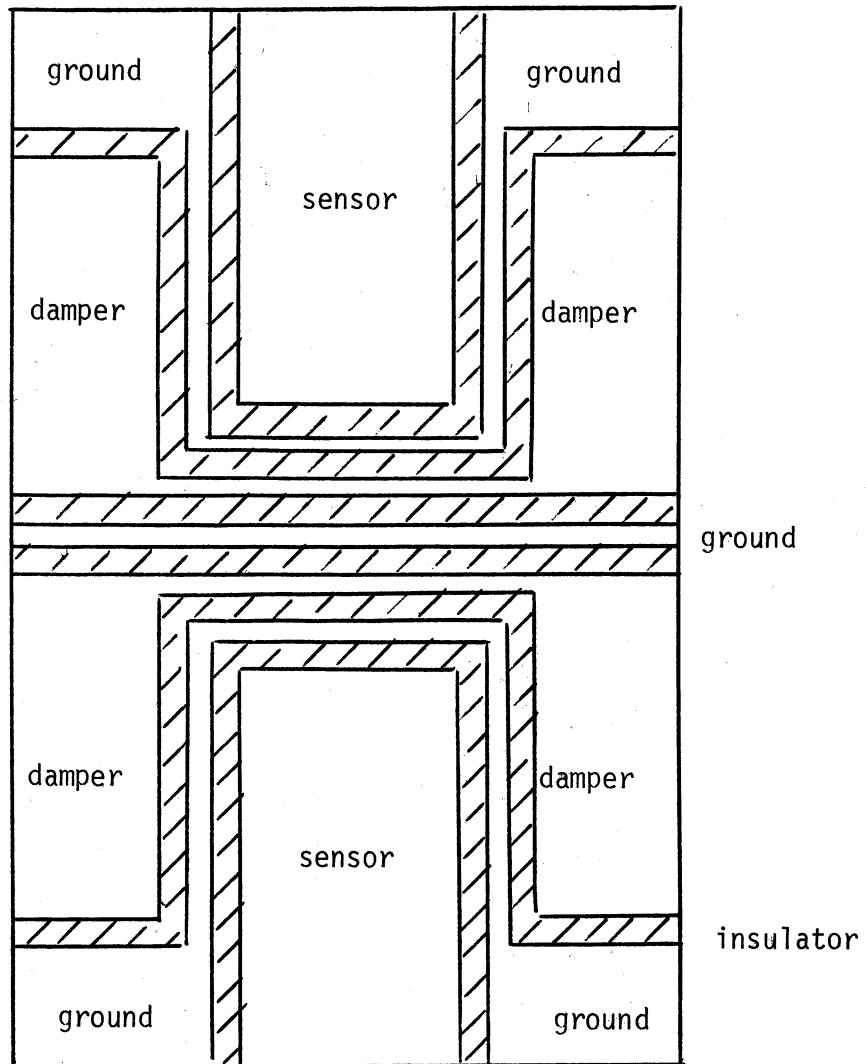

FIG. 6

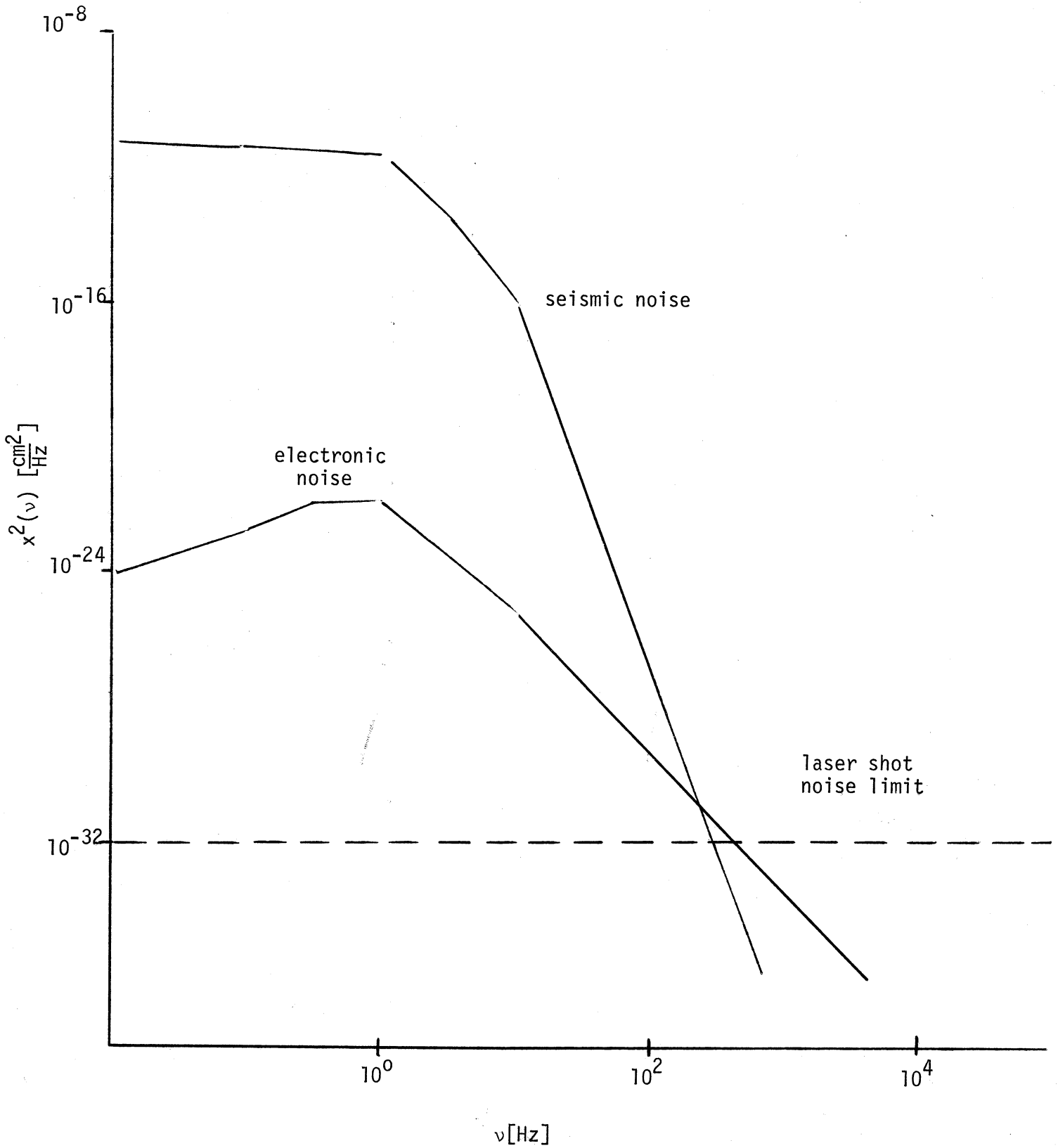

FIG. 7

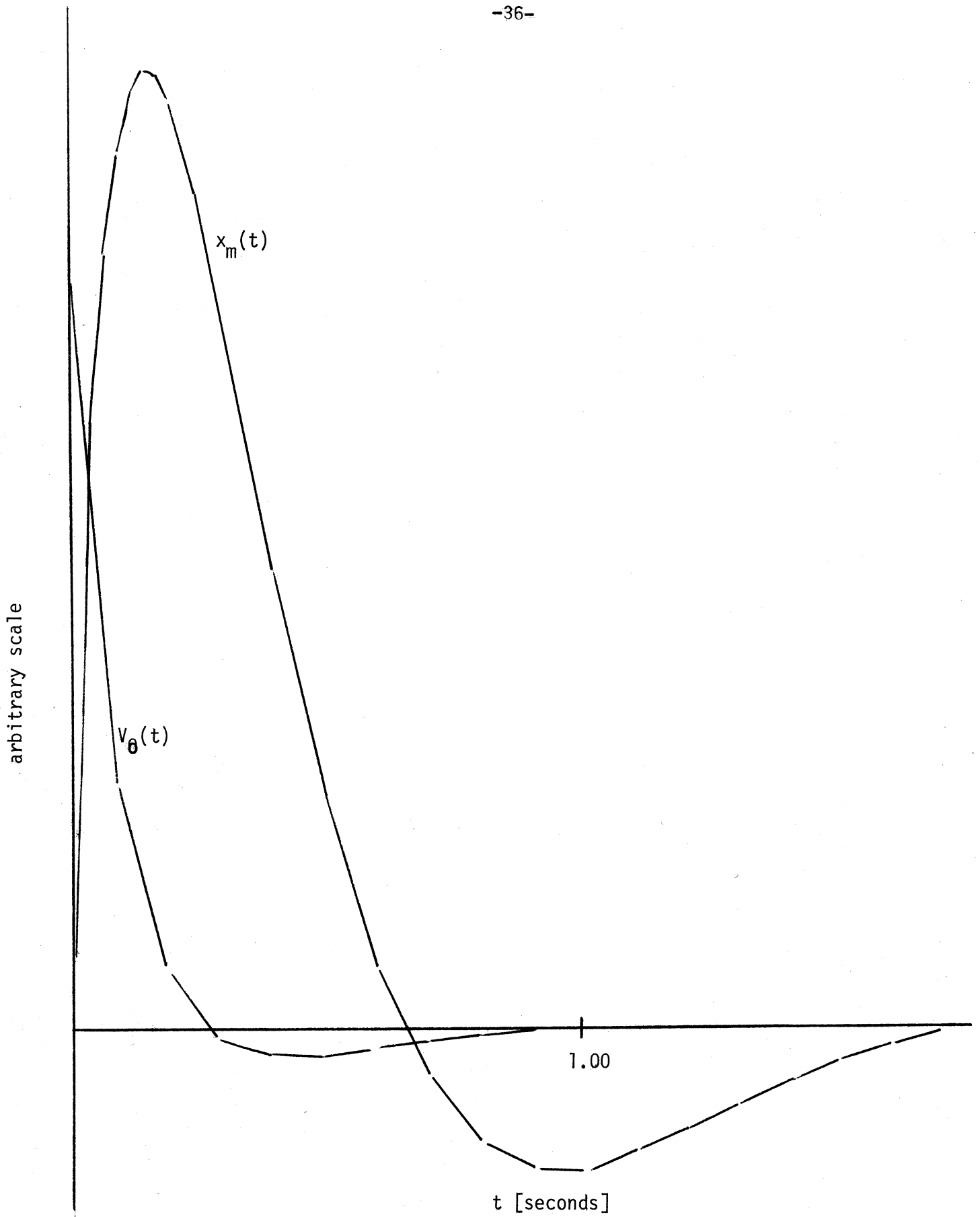

FIG. 8

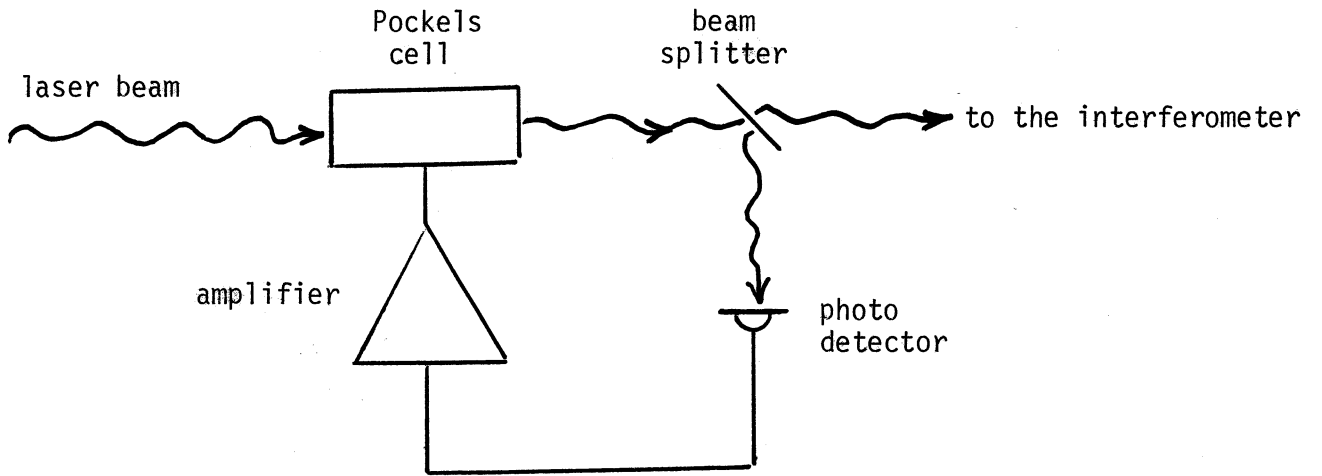

FIG. 9

BUDGET - RESEARCH GRANT RENEWAL

6/1/81 - 5/31/82

A. Salaries and Wages	
1. Senior Personnel	
a) Principal Investigator R. Weiss (11% - 9 mos., 100% - 1 mo.)	\$ 8,600
b) Co-investigator P. Lindsay (100% - 12 mos.)	24,000
2. Other Personnel	
a) Post Doctoral Scientist (100% - 9 mos.)	12,750
b) Technical Assistants	
1) D. Shoemaker (100% - 12 mos.)	15,000
2) R. Benford (50% - 12 mos.)	12,300
c) Electronics Technician (100% - 12 mos.)	15,000
3. Graduate Students - (Salary includes tuition)	
a) Antenna (100% - 12 mos.)	15,200
b) Isolation Stage (100% - 12 mos.)	15,200
4. Faculty Associates	
a) S. Ezekiel (5% - 9 mos., 100% - 1mo.)	6,270
b) E. Wright (5% - 9 mos.)	<u>1,130</u>
TOTAL SALARIES AND WAGES	\$ 125,450
B. Fringe Benefits (27% of S & W except students)	<u>25,664</u>
C. Total Salaries and Wages and F. B.	\$ 151,114
D. Industrial Consultants	
1. Arthur D. Little	20,000
2. Stone and Webster	10,000
E. Equipment	34,920
F. Expendable Supplies and Services	23,000
G. Travel	500
H. Publishing Costs	500
I. Secretarial Help (Agency)	1,000
J. Overhead	<u>96,685</u>
K. Total Costs	\$ 337,719

Note: Overhead = 1 month @ 70.5% of SW + FB - 50% Students SW
11 months @ 72% of SW + FB - 55% Students SW

1981/1982 EQUIPMENT AND SUPPLIES

EQUIPMENT

Digital Storage Scope		
Textronix #463	\$5,600	
Signal Averaging	200	
Cart: #200 C	235	
2 Probes: P6063B	<u>320</u>	
	\$6,355	\$ 6,355
6 NIMBINS and Power Supplies		
Ortec 401A/402D		7,050
6 High Voltage Supplies		
Power Designs #1570		3,450
LSI-11 Microprocessor		
Floating Point Processor		
11/23 Microprocessor		
Twin Floppy Discs		
IEEE-488 Interface		
Graphics Terminal	15,600	
11% Discount	<u>- 1,716</u>	
	13,884	
Fortran (Fully Supported)	<u>2,900</u>	
	\$16,784	16,784
Oscilloscope Amplifier		
Textronix 7A18	1,080	
Option 06 DC Offset	<u>200</u>	
	\$1,280	<u>1,280</u>
TOTAL		\$34,920

EXPENDABLE SUPPLIES AND SERVICES

Replacement Discharge Tube for Spectra Physics #165-03 Laser	\$ 5,990
Miscellaneous Optical Components	2,000
Shop Time and Materials	5,000
Electronic Components	<u>10,000</u>
TOTAL	\$23,000

1982/1983 EQUIPMENT AND SUPPLIES

VAX-11/750 Computer		
VAX-11/750 CPU		
1 Mbyte Memory		
4 Kbyte Cache Memory		
RM 03 Disc Drive		
TS11 CA Tape Drive		
LA 38 Hardcopy Unit		
VAX Operating System		
5 Weeks of Training	\$ 125,000	
Educational Discount	- <u>14,300</u>	
	\$ 110,700	\$ 110,700
Fortran (Fully Supported)		
QD 100 AG		8,000
VS11 Graphics Terminal		10,000
Maintenance Contract		
Basic Service Agreement		<u>7,812</u>
	TOTAL	<u>136,512</u>
NASA contribution COBE Project		<u>68,256</u>
TOTAL FOR COMPUTER		\$ 68,256

EXPENDABLE SUPPLIES AND SERVICES

Miscellaneous Optical Components	\$ 4,000
Shop Time and Materials	5,000
Electronic Components	10,000
Vacuum Plumbing	<u>2,000</u>
TOTAL	\$ 21,000

BUDGET - RESEARCH GRANT RENEWAL

6/1/83 - 5/31/84

A.	Salaries and Wages	
1.	Senior Personnel	
a)	Principal Investigator R. Weiss (11% - 9 mos., 100% - 1 mo.)	\$ 10,450
b)	Co-investigator P. Lindsay (100% - 12 mos.)	29,040
2.	Other Personnel	
a)	Post Doctoral Scientist (100% - 9 mos.)	20,570
b)	Technical Assistants	
1)	D. Shoemaker (100% - 12 mos.)	18,150
2)	R. Benford (50% - 12 mos.)	14,850
c)	Electronics Technician (100% - 12 mos.)	18,150
3.	Graduate Students - (Salary includes tuition)	
a)	Antenna (100% - 12 mos.)	18,370
b)	Isolation Stage (100% - 12 mos.)	18,370
4.	Faculty Associates	
a)	S. Ezekiel (5% - 9 mos., 100% - 1 mo.)	7,590
b)	E. Wright (5% - 9 mos.)	<u>1,364</u>
	TOTAL SALARIES AND WAGES	\$ 156,904
B.	Fringe Benefits (27.5% of S & W except students)	<u>33,045</u>
C.	Total Salaries and Wages and F.B.	\$ 189,949
D.	Industrial Consultants	
1.	Arthur D. Little	30,000
2.	Stone and Webster	70,000
E.	Equipment (Digital Scope and Laser)	47,000
F.	Expendable Supplies and Services	22,000
G.	Travel	800
H.	Publishing Costs	3,000
I.	Secretarial Help (Agency)	2,000
J.	Overhead (51.5%)	<u>112,633</u>
K.	Total Costs	\$ 477,382

1983/1984 EQUIPMENT AND SUPPLIES

Argon Ion Laser		
Spectra Physics #171-05 (or equivalent)	\$	36,900
Tektronix Oscilloscope		
7704A Mainframe		4,220
2: 7A26 Amplifier	\$1,745	3,490
7B80 Time Base	1,190	
Option 02, X-7	<u>100</u>	
	\$1,290	1,290
7B85 Delaying Time Base		1,425
Tek Lab Cart Model 3		<u>425</u>
	\$	10,850

MATERIALS AND SERVICES

Optical Components	\$	4,000
Shop Time and Materials		6,000
Electronic Components		10,000
Vacuum Supplies		2,000

APPENDIX I - ACTIVE SEISMIC ISOLATION

An ideally seismically isolated body is unaccelerated relative to inertial space - the reference frame determined by distant matter. Such a body experiences no net forces and, if furthermore it is an extended body, no torques about its center of mass - in other words it is a truly free mass. Terrestrially, it is necessary to support masses against earth gravity but this is no impediment to approximating a free mass as the support forces can be arranged to have an arbitrarily small gradient. It is, however, an enormous nuisance to work with free masses as anyone who has experimented with an almost astatic system knows (try it - an inverted pendulum supported by a cantilever spring is a good beginning). There is no stability.

The strategy we have adopted for seismic isolation is to shape the seismic transmission, by active means, to render the isolated mass effectively free in the frequency band of interest for gravitational wave detection. For broad band electromagnetically coupled antennas this is a more difficult enterprise than for single frequency acoustic antennas especially at low frequencies, $f < 20\text{HZ}$, where the promise for electromagnetically coupled antennas most probably lies. At still lower frequencies the limit due to local gravity gradient noise intrudes.

The time honored method of providing seismic isolation is to suspend with spring (electric, magnetic, mechanical, fluid) and a damper. For simplicity, let us consider only a one dimensional system (in the real world the other dimensions are extremely important, in fact are a source of a major problem through oscillator mode cross coupling) Refer to Figure 1; the ground motion relative to inertial space is $x_e(\omega)$ while the suspended mass motion driven through the spring and damper is $x_p(\omega)$. The magnitude of the suspended mass motion is

$$|x_p(\omega)| = \frac{|T_e(\omega)|}{|T_p(\omega)|} |x_e(\omega)| = \left| \frac{\omega_o^2 + \left(\frac{\omega}{\omega_o}\right)^2}{(\omega_o^2 - \omega^2) + \frac{\omega^2}{Q}} \right|^{1/2} |x_e(\omega)|$$

the terms, which at this juncture appear like a cumbersome notation, are the following:

$$T_p(\omega) = K_p - m\omega^2 + j \frac{\omega\omega_0 m}{Q}$$

is the transfer function relating suspended mass motion to applied force.

$$T_e(\omega) = K_p + j \frac{\omega\omega_0 m}{Q}$$

is the transfer function that relates ground motion to force. Q , K , ω_0 ; and m have the usual meaning; quality factor, spring constant, driven resonance frequency, and mass. The seismic transmission is defined by the ratio

$$\frac{|x_p(\omega)|}{|x_e(\omega)|} = \begin{cases} 1 & ; \omega/\omega_0 \ll 1 \\ Q & ; \omega = \omega_0 \\ (\frac{\omega_0}{\omega})^2 & ; \frac{\omega}{\omega_0} \gg 1 \end{cases}$$

There is no isolation at frequencies below the resonance; the resonance is the price paid for isolation at higher frequencies which varies only as fast as the inverse square of the frequency. Commercial vibration isolation systems are based on the above principle - Bendix, Barry Controls.....with lowest resonant frequency in the region of several Hertz, and critically damped - $Q \approx 1/2$ - to suppress the resonance. The isolation varies more nearly as $1/\omega$ in this situation. These systems work moderately well, as any passenger of a car knows first hand, but are inadequate to isolate the ground noise at the levels required for gravitational wave research; especially at low frequencies where the ground noise amplitude excitation spectrum varies $\sim 1/f^4$. The naive directions in which to go are 1) reduce the resonant frequencies - and/or 2) compound isolation systems. Both of these are troublesome: reducing the resonant frequencies enough would lead to astatic and, therefore virtually unstable systems, while compounding isolation stages - clearly a part of any viable isolation scheme - has to be carried out judiciously otherwise the multiple coupled oscillators become unmanageable. In this as all other mechanical design the axiom for success is "free one mode at a time making all efforts to keep the resonant frequencies in the remaining modes as high as possible."

One solution we have mocked up in the laboratory in one dimension only, but with a plan to extending it to all three degrees of translation and rotation, is to use an accelerometer or seismometer mounted on the body to be isolated as a reference element in a null servo system. A controller, mounted on the ground exerts forces on the body to be isolated so as to drive the reference element to a null output. This implies that the body though still quite firmly attached to the ground is nevertheless vibration free relative to inertial space in a frequency band determined by the servo system filters. The resonance within the reference element as well as those of the isolated object (a platform) are damped electronically. The mechanical Q can be high so that the equivalent noise temperature of the reference is a few degrees Kelvin with moderate care in amplifier and transducer design. In a properly designed system of this sort the residual noise motion of the isolated object is limited by the Nyquist noise forces in the reference element, the displacement detector amplifier ~~input noise~~ and, to a lesser extent in a practical system, by the backreaction of the amplifier noise through the displacement transducer on the reference. The noise analysis is quite similar to the process of optimizing the signal to noise in acoustic gravitational antenna.

Ultimately such a system could be applied directly to the antenna masses or in a compound arrangement to the platform from which the antenna masses are themselves suspended.

The idea is quite old - in my life it stems from conversation with Bob Dicke in the early 1960's when he and I attempted an actively isolated system of this type but in which we tried to isolate all degrees of freedom on a single platform simultaneously. In short, the device did not work as not enough thought was put into the suppression of cross coupling of the

multiple modes of this single system. Our present plan is to follow the axiom stated above.

The analysis of such a system in one dimension follows. The inertial reference (seismic) element mounted on the platform is itself used in a null servo configuration. Refer to figure 2. m_s is the seismic mass coupled to the platform through spring K_s and damper α_s . The displacement detector is a differential capacitor system with the outer plates tied to the platform. $T_1(\omega)$ is the voltage to voltage transfer function of the phase sensitive demodulator and amplifier while $T_2(\omega)$ includes the servo filters and the conversion of output voltage to applied force F_c . F_c in the present system is provided by a loudspeaker movement linear motor. The noise in the system is characterized by current and voltage noise sources at the amplifier input as well as by the thermal Nyquist force, F_{th} , acting on the seismic reference mass directly. The equation of motion of the seismic mass is:

$$T_s(\omega) x_s(\omega) = F_{th}(\omega) + F_{Br}(\omega) + T_{sp}(\omega) x_p(\omega) + F_c(\omega)$$

where

$$T_s(\omega) = \frac{-m_s \omega^2 + K_s + j\omega \alpha_s m_s}{Q_s} \qquad \alpha_s = \frac{\omega_{os} m_s}{Q_s}$$

$$T_{sp}(\omega) = K_s + j\omega \alpha_s m_s$$

The output voltage is

$$V_{out}(\omega) = T_1(\omega) [(X_s(\omega) - X_p(\omega)) \frac{V_0}{d} + e_n^x(\omega)]$$

where $e_n^x(\omega) = (e_n^2(\omega) + i_n(\omega)Z^2)^{1/2}$

Z is the source impedance of the capacitive transducer, it is equal to $1/j \omega c$ where ω is the capacitor bridge drive frequency.

The control force is given by

$$F_c(\omega) = T_2(\omega) V_{out}(\omega)$$

The two direct noise forces are the Nyquist force spectral density

$$F_{th}^2(\omega) = \frac{4KTm_s \omega^2 \alpha^2}{Q_s}$$

and the amplifier-transducer back reaction force density

$$F_{BR}^2(\omega) = \left(\frac{1}{2\pi} \frac{A}{d^2} \alpha^2 V_0 \right)^2 i_n^2(\omega) Z^2 \quad \alpha = \frac{1}{300} \quad \text{cgs to MKS conversion}$$

A is the plate area.

Combining the equation, noting that the noise terms combine in squares, gives

$$V_{out}(\omega) = \frac{T(\omega) \frac{V_0}{d} \left[F_{th}^2(\omega) + F_{BR}^2(\omega) + (T_s(\omega) \frac{d}{V_0})^2 e_n^2(\omega) \right]^{1/2} + m_s \omega^2 x_p(\omega)}{(T_s(\omega) - T_1(\omega) T_2(\omega) \frac{V_0}{d})}$$

It is interesting to note that if the amplifier noise sources are matched to the transducer impedance the optimum capacitor drive voltage, assuming that the thermal noise can be made negligible, is given by

$$V_{0 \text{ optimum}} = \frac{2^{1/4}}{\alpha} \frac{(2\pi |T_s(\omega)| d^3)^{1/2}}{A}$$

Next the equation of motion of the platform driven by the ground motion and the seismic-reference output are considered. Refer to figure 3. m_p is the platform mass coupled to the ground by spring K_p and damper α_p . The reference output signal is filtered by $T_3(\omega)$ and applied to controller F_c , again a linear motor (part of a computer disc drive - a glorified loud-speaker movement able to provide kilograms of force). A general noise force, F_n ,

on the platform is included in the analysis to accommodate acoustic and other disturbances not coupled from the ground. The equation of motion for this system is

$$T_p(\omega)X_p(\omega) \cong F_N(\omega) + F_C(\omega) + T_e(\omega)X_e(\omega)$$

The approximate equality is used to indicate that the direct force due to the reaction of the seismic reference on the platform have been neglected in this simple presentation. They complicate the analysis and are furthermore not important terms if the reference element is itself incorporated in a null servo system. The control force is

$$F_C(\omega) = T_3(\omega) V_{out}(\omega)$$

The closed feedback loop response of the platform determined by combining the above equations is given by

$$X_p(\omega) = \frac{T(\omega) [(F_{th}^2(\omega) + F_{BR}^2(\omega) + (T_S(\omega) \frac{d}{V_0})^2 e_n^2(\omega) + \frac{F_n^2(\omega)}{T^2(\omega)})]^{1/2} + T_e X_e(\omega)}{T_p(\omega) - T(\omega)m_s \omega^2}$$

where $T(\omega) = \frac{T_3(\omega) T_1(\omega) \frac{V_0}{d}}{T_S(\omega) - T_1(\omega)T_2(\omega)\frac{V_0}{d}}$ is the forward transfer

function of the system.

In the limit of large forward gains,

$$|T(\omega) m_s \omega^2| \gg |T_p(\omega)|, \quad \text{the motion of the platform}$$

is determined by the reference element intrinsic noise.

$$X_p(\omega) \rightarrow \frac{[F_{th}^2(\omega) + F_{BR}^2(\omega) + (T_S(\omega) \frac{d}{V_0})^2 e_n^2(\omega)]^{1/2}}{m_s \omega^2}$$

We have constructed and tested a demonstration of this type of isolation system. The system used a commercially available (Kinematics) ~~feedback accelerometer as reference element~~. The limitation in the present system stems from this unmodified accelerometer due to its large amplifier noise and limited bandwidth. The results are sufficiently encouraging to pursue this concept: first, by modifying the accelerometer with our quiet and broadband RF displacement sensor electronics and secondly by extending the system to all three dimensions. The parameters of the demonstration system are

Reference element

$$m_s = 3 \text{ grams} \qquad f_{os} = 14\text{Hz} \qquad Q_{os} = 10$$

$$T_2(\omega) = 1.2 \times 10^3 \text{ dynes/volt} \qquad \text{flat to } 50 \text{ Hz}$$

$$e_n(\omega) \sim 4 \times 10^{-8} \text{ v/Hz}^{1/2}, \quad i_n(\omega) \sim 1 \times 10^{-13} \text{ amp/Hz}^{1/2} \quad Z_t \sim 1.5 \times 10^6 \Omega$$

Platform

$$m_p = 9.5 \times 10^3 \text{ grams} \qquad f_{op} = 3.081 \text{ Hz} \qquad Q_{op} = 20$$

$$T_3(\omega) = 3.6 \times 10^9 \text{ (dynes/volt)} \frac{j \omega \tau_d}{(1 + j\omega\tau_d)(1 + j\omega\tau_{int})}$$

$$\tau_d = 33 \text{ sec}, \quad \tau_{int} = 4.7 \text{ sec}$$

The performance of the system is shown in figure 4 which shows the platform acceleration spectrum as observed with both the servo on and off. The ground noise attenuation at low frequency is limited by the finite forward loop bandwidth determined by the commercial accelerometer electronics while at higher frequencies the spectra are dominated by amplifier current noise. The electronics can be improved by a factor of 10 before the thermal noise in this accelerometer becomes dominant.

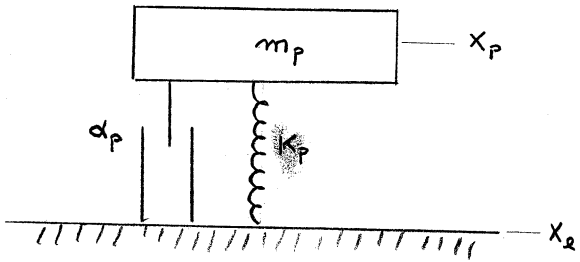

Fig.1 A simple isolation stage

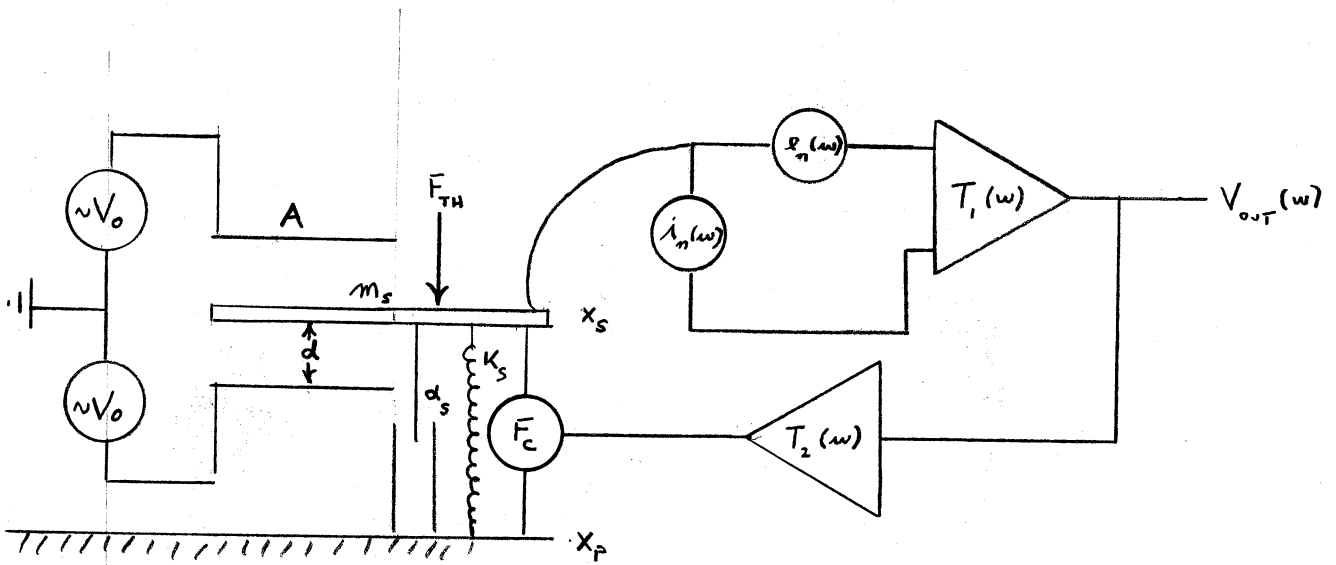

Fig.2 Inertial reference incorporated in a null servo loop

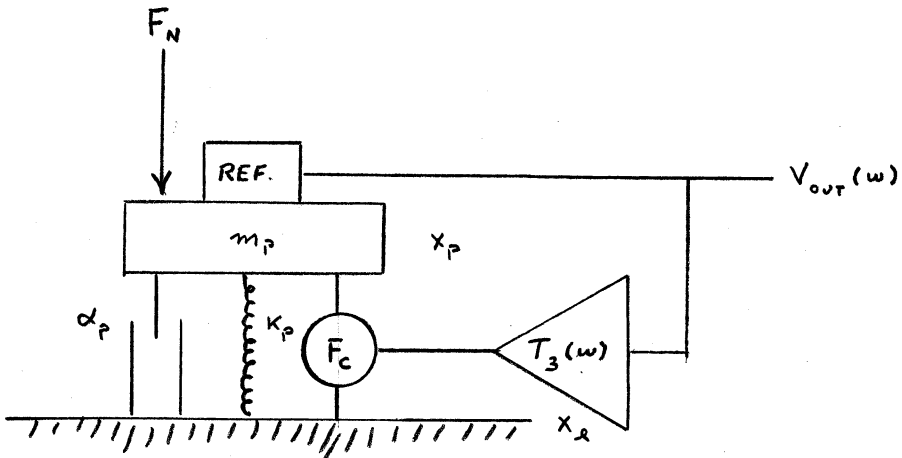

Fig.3 Active isolation stage incorporating reference in a null servo loop

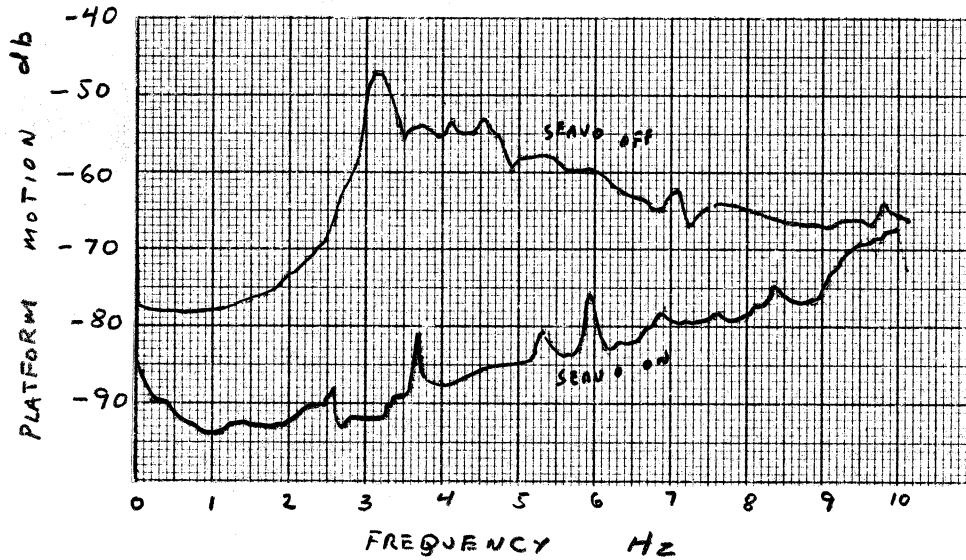

Fig.4 Sample acceleration spectra of the demonstration active isolation system. 0 db corresponds to $13.8 \text{ cm/sec}^2/\text{Hz}^{1/2}$

APPENDIX II - DESCRIPTION OF THE PROTOTYPE ANTENNA (from 1978 Proposal)

A schematic drawing of the antenna now partially constructed at MIT is shown in Figure 1. Three masses are suspended on horizontal seismometer mounts in high vacuum ($P < 10^{-7}$ torr). The three masses are the mirror mounts of an equal arm Michelson interferometer illuminated by a commercial 1-watt Argon ion laser. Each interferometer arm is a 1.3 meter long reentrant optical delay line comprised of dielectric coated spherical mirrors in a near confocal configuration. The laser beam is split by a 50-50 beam splitter and enters the delay lines through a hole in the spherical mirrors. The beam makes approximately 200 passes in each cavity before reemerging through the same hole by which it entered. The emerging beam passes through Pockel's cell phase shifters and is recombined by the beam splitter after which it is detected by a water cooled PIN Silicon photo diode.

The interferometer is held on a fixed point of a single fringe by a servo system using electro-optic (Pockel's cell) phase shifters as controllers and modulators. The servo error signal is derived by modulating the optical phase in oppositely polarized Pockel's cells in the two interferometer arms by $\pm \pi/4$ at a 3 MHz rate. The fringe phase modulation is synchronously demodulated yielding an error signal which is applied to the controllers to maintain the fringe modulation symmetry. This signal is proportional to the differential displacement of the antenna masses and is the antenna output. The error signal is applied to the Pockel's cell phase modulators to control small amplitude high frequency fringe excursions and after low pass filtering to electrostatic controllers that apply forces directly on the antenna masses to control large amplitude low frequency excitations. The antenna operated as a null servo system is insensitive

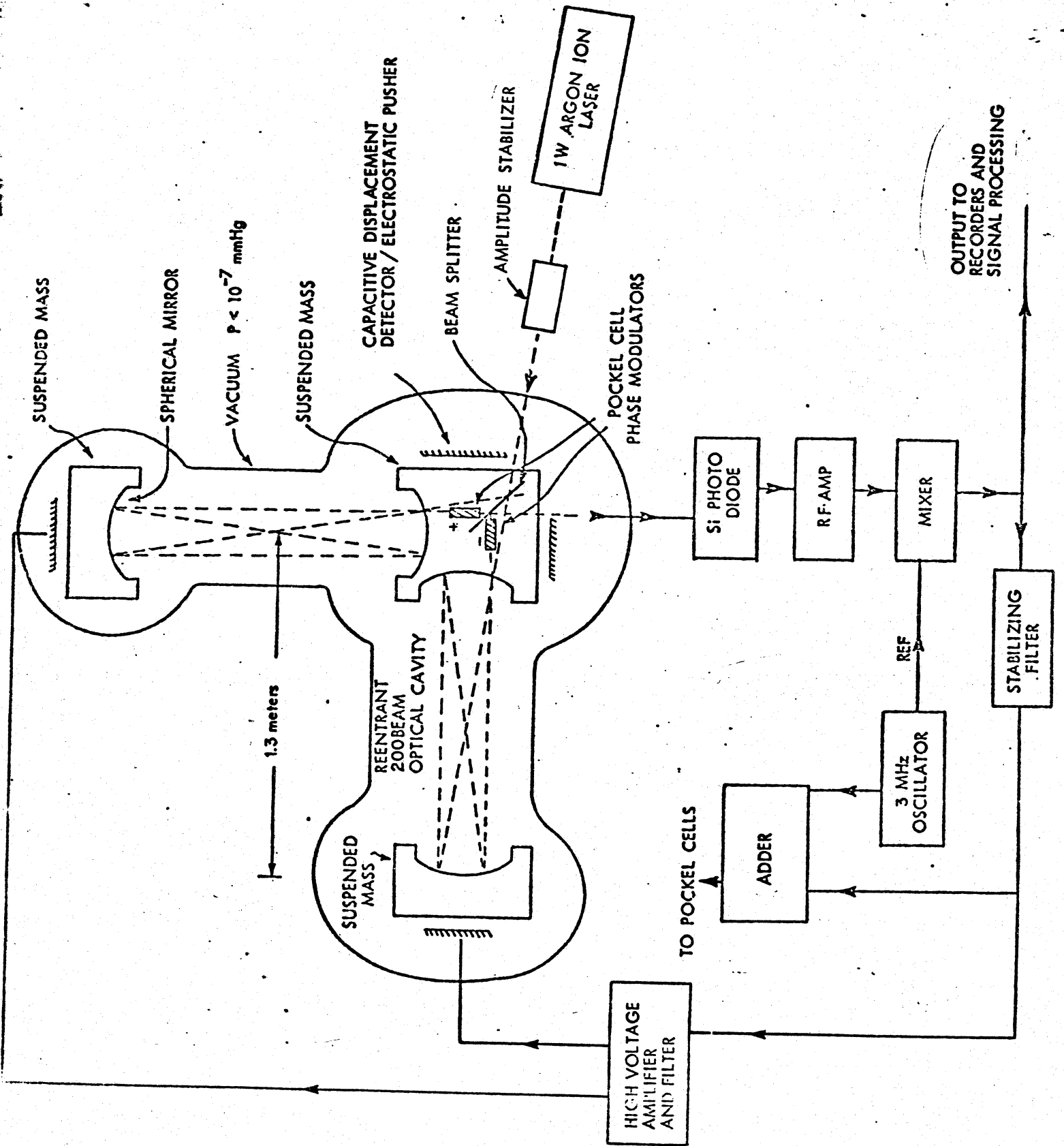

FIG. 1. Schematic drawing of the antenna being constructed at MIT.

to gain variations and has reduced sensitivity to laser amplitude noise at frequencies other than the modulation frequency. The open loop gain of the servo is, however, not sufficient to accommodate the full extent of the low frequency amplitude noise of the commercial argon laser. An external amplitude stabilizing servo system employing an electro-optic amplitude modulator is used between the laser and the interferometer to reduce the amplitude noise due to plasma oscillations and acoustic noise to acceptable limits.

The frequency stability of the laser is not critical provided that the difference in optical delay in the two interferometer arms is much less than the reciprocal of the oscillating laser line width.

The multipass delay lines that comprise the interferometer arms are useful components in an interferometric antenna as long as the Poisson amplitude noise dominates the antenna noise budget and the delay line storage times remain less than $1/2$ the period of the gravitational wave. For fixed laser power, the multipass arms increase the fringe phase sensitivity of the interferometer by the number of passes per arm. The number of passes is limited by the reflectivity and optical quality of the mirror surfaces.

As long as the Poisson amplitude noise is dominant, the optical delay line is equivalent to increasing the length of the antenna; however, at those frequencies where noise sources, such as thermal and ground noise, that physically move the end mass dominate, the only way to increase the signal-to-noise ratio is to actually increase the antenna baseline.

Optical delay lines using spherical mirrors have been described by Herriott. D. K. Owens at MIT has studied and constructed delay lines using spherical mirrors. He has discovered several interesting and useful

properties of these delay lines. The most encouraging one is that the delay lines are easy to align. If the reentrant condition is satisfied, namely that the input and output beams pass through the same hole, the delay line behaves as though the beam is reflected by the back of the front surface of the mirror which has the coupling hole in it. The position of the output beam is independent of the transverse position and angle of the far mirror as long as the beam pattern does not spill off of the mirrors. If the reentrant condition is satisfied, the time delay of the beam in the cavity is insensitive in first order to transverse motions and rotations of the far mirror.

The mirrors in the prototype antenna are 4 inches in diameter, have a radius of 1.3 meters, a reflectivity of 99.5% at 5145A and are good to 1/10 of a wavelength over their entire surface. The coupling hole has a diameter of 2.5 mm.

The design of the suspensions for the antenna masses has defied a simple, elegant and economical solution. The suspensions have to satisfy several conditions. First, they must have a high Q to reduce the coupling to thermal fluctuations. Second, they must provide isolation from ground and acoustic noise. What makes the problem difficult is the inevitable collection of normal modes of motion of a mechanical system which cross-couple and by parametric conversion transfer energy between each other. In other words, the isolation calculated for a long period suspension is never realized in practice because the suspension structure has its own resonances that couple into the principle mode of the suspension. This is a problem that has long been recognized in the design of seismometers and gravimeters. A rule of thumb to minimize this problem in suspensions is to keep them simple and to force the resonances of the structural members toward high frequencies.

OTHER SOURCES OF SUPPORT OF FACULTY ON THIS PROPOSAL

R. Weiss

NASA	"Astronomy in the Region Between 1 mm and 0.1 mm Wavelengths"			
		FY 1981	\$70,470	5% Salary
NASA	Phase B Study of COBE (Cosmic Background Explorer Satellite)			
		FY 1981	\$57,040	17% Salary

E. Wright

NASA	Phase B Study of COBE			
		FY 1981	\$57,040	33% Salary

S. Ezekiel

NSF	"Atom-Field Interactions"			
		FY 1981	\$90,000	10% Salary
Air Force/Rome Development Ct.	"Micro-wave Frequency Standards Using Lasers"			
		FY 1981	\$90,000	10% Salary
Air Force/Geophysical Lab	"Optical Inertial Rotation Sensors"			
		FY 1981	\$75,000	15% Salary
Joint Services Electronics Program (RLE-MIT)				
		FY 1981	\$80,000	15% Salary

Biographical Sketch

Rainer Weiss

Date of Birth: September 29, 1932 Title: Professor of Physics
Place of Birth: Berlin, Germany
Citizenship: U.S.A.

Education

Massachusetts Institute of Technology B.S. 1955
Massachusetts Institute of Technology Ph.D. 1962

Professional Experience

1973 - Present Professor of Physics, M.I.T.
1967 - 1973 Associate Professor of Physics, M.I.T.
1964 - 1967 Assistant Professor of Physics, M.I.T.
1962 - 1964 Research Associate in Physics, Princeton University
1961 - 1962 Assistant Professor of Physics, Tufts University
1960 - 1961 Instructor of Physics, Tufts University

Public Service

Member, NASA Physical Science Committee, 1970 - 1974
Member, National Academy Summer Study on Outer Planet Exploration, 1972
Member, NASA Shuttle Working Group, 1973 -
Member, NASA Infrared Working Group, 1973 -
Chairman, NASA Panel on Experimental Relativity and Gravitation, 1974 - 1976
Member, NCAR Scientific Ballooning Advisory Panel, 1971 - 1976
Chairman, NCAR Scientific Ballooning Advisory Panel, 1974 - 1976
Members Representative to NCAR from M.I.T., 1974 -
Chairman, NSF Subcommittee on Gravitational Physics, 1978
Member, NASA SSSC Committee, 1979 -
Member NASA Infrared Detector Panel, 1978

Publications by Rainer Weiss

1. "Magnetic Moments and Hyperfine Structure Anomalies of Cs^{133} , Cs^{135} , and Cs^{137} ," Phys. Rev. 105, 590 (1957), with H. H. Stroke, V. Jaccarino, and D. S. Edmonds.
2. "Molecular Beam Electron Bombardment Detector," Rev. Sci. Instr. 32, 397 (1961).
3. "A Search for a Frequency Shift of 14.4 KeV Photons on Traversing Radiation Fields," Physics Letters 1, 342 (1962), with L. Grodzins.
4. "Stark Effect and Hyperfine Structure of Hydrogen Fluoride," Phys. Rev. 131, 659 (1963).
5. "A Gravimeter to Monitor the $O_S O$ Dilational Mode of the Earth," J. Geophys. Res. 70, 5615 (1966), with B. Block.
6. "Experimental Test of the Freundlich Red-Shift Hypothesis," Phys. Rev. 155, 1412 (1967), with G. Blum.
7. "Electric and Magnetic Field Probes," Am. J. Phys. 35, 1047 (1967).
8. "Laser-Induced Fluorescence in a Molecular Beam of Iodine," Phys. Rev. Let. 20, 91 (1968), with S. Ezekiel.
9. "A Measurement of the Isotropic Background Radiation in the Far Infrared," Phys. Rev. Let. 24, 742 (1970), with D. Muehlner.
10. "Electromagnetically Coupled Broadband Gravitational Antenna," Quarterly Progress Report, Research Lab. of Electronics, M.I.T., 105, 54 (1972).
11. "Balloon Measurements of the Far Infrared Background Radiation," Phys. Rev. D 7, 326 (1973), with D. Muehlner.
12. "Further Measurements of the Submillimeter Background at Balloon Altitude," Phys. Rev. Let. 30, 757 (1973), with D. Muehlner.
13. "Measurements of the Phase Fluctuations in a He-Ne Zeeman Laser," Rev. Sci. Inst. 45, 1060 (1974), with D. K. Owens.
14. "The Oldest Fossil" Technology Review 78, P 56 1975

Publications by Rainer Weiss cont'd

15. "A Large Beam Sky Survey at Millimeter and Submillimeter Wavelengths made from Balloon Altitudes" *Astrophysical Journal* 231, 702 (1979) with D.K.Owens and D.J.Muehlner
16. "Gravitational Radiation - The Status of the Experiments and Prospects for the Future" in Sources of Gravitational Radiation, Cambridge University Press, Cambridge, England (1979)
17. "Monolithic Silicon Bolometers" *Journal of Infrared and Millimeter Waves* 1 (1980) in press. with P.M.Downey, F.J.Bachner, J.P.Donnely, W.T.Lindley R.W.Mountain and D.J.Silversmith
18. "Measurements of the Cosmic Background Radiation" *Annual Review of Astronomy and Astrophysics* 18, 489 (1980)
19. "The COBE project" *Physica Scripta* 21, 670 (1980)

Reports

- "Study Report for the Cosmic Background Explorer" Goddard Space Flight Center, Feb. 1977. with S. Gulkis, M. Hauser, J. Mather, G. Smoot, D. Wilkinson
- "Report of the Sub - Panel on Relativity and Gravitation", Management and Operations Working Group for Shuttle Astronomy, NASA Headquarters, Sept. 1976. with P. Bender, C. Misner, R. V. Pound
- "Report of the Detector Study Panel NASA" with P. Richards (Chairman) 1979

Biographical Sketch

Name: Paul S. Linsay

Date of Birth: August 13, 1947

Address: Massachusetts Institute of Technology
Department of Physics
Cambridge, Massachusetts 02139

Phone: 617-253-4824

Education: Ph.D., University of Chicago, (Physics) 1976
Chicago, Illinois

S.M., University of Chicago, (Physics) 1970
Chicago, Illinois

S.B., Massachusetts Institute of Technology,
(Mathematics/Physics) 1969
Cambridge, Massachusetts

Awards: Laboratory Graduate Participant Fellowship
Argonne National Laboratory
Argonne, Illinois
1972-1976

Scholarship for International School of Subnuclear
Physics, "Ettore Majorana" Center for Scientific
Culture, Erice, Sicily
July 1974

Research Experience: Postdoctoral Research Associate - 1979 - Present
Massachusetts Institute of Technology
Cambridge, Massachusetts 02139

Research Fellow in Physics - 1976 - 1979
California Institute of Technology
Pasadena, California 91125

Research Assistant - 1971 - 1976
Prof. James W. Cronin
University of Chicago
Chicago, Illinois 60637

Research Assistant - 1970 - 1971
Prof. Roland Winston
University of Chicago
Chicago, Illinois 60637

Teaching Experience: Teaching Assistant - 1976 - 1977
California Institute of Technology
Mechanics, Waves, and Oscillations

Teaching Assistant - 1969 - 1970
University of Chicago
Mechanics

Publications List

PAUL LINSAY

1. Measurement of the Decay Rate for the Rare Process $K_L^0 \rightarrow \mu^+ \mu^-$.
M.J. Shochet, P. Linsay, C. Grosso-Pilcher, H. J. Frisch, R. DeVoe, J. W. Cronin, and D. R. Moffett,
Phys. Rev. Lett. 39, 59 (1977).
Physical Review D19, 1965 (1979).
2. Measurement of the Branching Ratio $\Gamma(K_L^0 \rightarrow \pi^+ \pi^-) / \Gamma(K_L^0 \rightarrow \text{all})$.
R. DeVoe, J. W. Cronin, H. J. Frisch, C. Grosso-Pilcher, P. Linsay, M. J. Shochet, and D. R. Moffett,
Physical Review D16, 565 (1977).
3. Very Large Area Scintillation Counters for Hadron Calorimetry.
B. Barish, A. Bodek, Y. K. Chu, K. Kleinknecht, J. Lee, P. S. Linsay, J. Ludwig, F. Sciulli, and M. Shaevitz,
Published in IEEE Transactions in Nuclear Science, NS-25, p.532, Feb. 1978, talk presented at the 1977 Nuclear Science Symposium, San Francisco, Calif., Oct. 1977.
4. Density Dependence of 2μ Rates in the CFNRR Experiment.
B. C. Barish, J. F. Bartlett, Y. K. Chu, K. Kleinknecht, J. Lee, P. S. Linsay, J. Ludwig, R. Messner, P. Mine, F. J. Sciulli, M. Shaevitz, E. Siskind, D. Edwards, H. Edwards, H. E. Fisk, G. Krafczyk, D. Nease, D. Buchholz, K. Nishikawa, A. Bodek, W. Marsh, and O. Fackler.
Published in Proceedings of the International Conference on Neutrino Physics and Neutrino Astrophysics, Purdue University, April 1978.
5. Flux Normalized Charged-Current Neutrino Cross Sections up to Neutrino Energies of 260 GeV.
B. C. Barish, R. Blair, J. Lee, P. Linsay, J. Ludwig, R. Messner, F. Sciulli, M. Shaevitz, F. Bartlett, D. Edwards, H. Edwards, E. Fisk, G. Krafczyk, Y. Fukushima, Q. Kerns, T. Kondo, D. Nease, S. Segler, D. Theriot, A. Bodek, W. Marsh, O. Fackler, and K. Jenkins.
Published in Proceedings of the Neutrino '79 International Conference in Bergen, Norway June 18-22, 1979.

BIOGRAPHICAL SKETCH

Shaoul Ezekiel

Date of Birth: July 20, 1935

Title: Professor

Citizenship: U.S.A.

Education

Imperial College of Science, London, England, Electrical Engineering - B.Sc., June, 1957.

Massachusetts Institute of Technology, Aeronautics and Astronautics - S.M., June, 1964.

Massachusetts Institute of Technology, Instrumentation - Sc.D. June, 1968.

Research and/or Professional Experience

Development Engineer - Carrier Communication & Data Handling
General Electric Company, Coventry, England, 1957-1959.

Research & Development Engineer - Flight Simulators, Canadian Aviation Electronics, Montreal, Canada, 1959-1962.

Research Assistant - M.I.T., 1962-1968.

Instructor - Dept. of Physics, M.I.T., January 1968 - July 1968.

Assistant Professor, Department of Aeronautics and Astronautics, M.I.T. July 1968 - June 1972.

Associate Professor, Department of Aeronautics and Astronautics, M.I.T. July 1972-June 1976.

Associate Professor, Department of Aeronautics and Astronautics, and Electrical Engineering & Computer Science, M.I.T. July 1976 - June 1978.

Professor, Department of Aeronautics and Astronautics, and Electrical Engineering and Computer Science, July 1978 - present.

Membership in Professional Societies

Fellow of the American Optical Society, Member of the American Physical Society and the Institute of Electrical and Electronic Engineering

Publications

1. "Sensitive Cryogenic Accelerometer," (with P.K. Chapman), Proceedings of Symposium on Unconventional Inertial Sensors, Polytechnique Institute of Brooklyn, Farmingdale, New York, October 1964.
2. "An Unconventional Inertial Measurement Technique," (with P.K. Chapman), Les Gyroscopes Avances, Memorial de L'Artillerie Francaises, 2⁶ fasc. 1965.
3. "A Superconducting Suspension for a Sensitive Accelerometer," (with P.K. Chapman), Review of Scientific Instruments, Januaru 1965.
4. "Determination of Auxiliary Mirror Curvature in a Michelson-Type Single Longitudinal Mode Resonator," IEEE J. of Quantum Electronics, October 1967.
5. "Laser-Induced Fluorescence in a Molecular Beam of Iodine," (with R. Weiss), Physical Review Letters, 15 January 1968.
6. "Investigations of Coherent Oscillations in an Argon-Ion Laser Plasma Tube," (with D.C. Galehouse, U. Ingard, and T.J. Ryan), Applied Physics Letters, January 1, 1971.
7. "Molecular Beam Stabilized Argon Laser," (with T.J. Ryan, D.G. Youmans, and L.A. Hackel), Applied Physics Letter, 1 October 1972.
8. "High-Resolution Spectroscopy of I₂ Using Laser-Molecular Beam Techniques," (with D.G. Youmans and L.A. Hackel), J. of Applied Physics, May 1973.
9. "Lasers," Optical Engineering, 12, G141, 1973.
10. "Coherence of Laser Light," Optical Engineering, 12, G183, 1973.
11. "Closed Loop, Real Time Holographic Interferometry," (with M.A. Dobbels and E.M. Stolle), Proceedings of Conference on Laser Engineering and Applications, May 1973.
12. "Micro-Angstrom Spectroscopy," (with L.A. Hackel and D.G. Youmans), J. Optical Society of America, 63, 907, 1973.
13. "Molecular Beam Stabilized Laser," (with L.A. Hackel and D.G. Youmans), Proceedings, 27th Annual Symposium on Frequency Control, U.S. Army Electronics Command, Fort Monmouth, New Jersey, 1973.
14. "Laser Molecular Beam Techniques for High-Resolution Spectroscopy," (with L.A. Hackel and D.G. Youmans), Proceedings of Fourth International Symposium on Molecular Beams, Cannes, France, July 9-12, 1973.

Publications (cont'd)

15. "Long-Term Laser-Frequency Stabilization Using a Molecular Beam Reference," (with D.G. Youmans and L.A. Hackel), Proceedings of Fourth International Symposium on Molecular Beams, Cannes, France, July 9-12, 1973.
16. "A Study of Vortex Rings Using a Laser Doppler Velocimeter," (with J.P. Sullivan and S.E. Widnall), AIAA Journal, October 1973.
17. "Laser Molecular Beam Measurement of Hyperfine Structure in the I₂ Spectrum," (with D.J. Ruben, S.G. Kukulich, L.A. Hackel and D.G. Youmans), Chemical Physics Letters, 1 October 1973.
18. "Jet Stream CW Dye Laser for High-Resolution Spectroscopy," (with R.E. Grove, F.Y. Wu, L.A. Hackel and D.G. Youmans), App. Phys. Letters, 15 October 1973.
19. "High-Resolution Holographic Contour Generation Using a Pulsed Multicolor Ion Laser," (with P. Henshaw), Applied Optics, November 1973.
20. "A Two-Component Laser Doppler Velocimeter for Periodic Flow Fields," (with J.P. Sullivan), J. Phys. E: Scientific Instruments, April 1974.
21. "Molecular Beam Spectroscopy with Argon and Dye Lasers," in Laser Spectroscopy, Eds. Brewer and Mooradian, (Plenum Press), April 1974.
22. "Laser-Frequency Stabilization," Optical Engineering, 13, G5, 1974.
23. "Lasers—Who Needs Them!" Optical Engineering, 13, G53, 1974.
24. "High-Resolution Molecular Beam Spectroscopy," (with L.A. Hackel and D.G. Youmans), J. Optical Society of America, 64, 529, 1974.
25. "Precision Molecular Beam Spectroscopy with Argon and Dye Lasers," (with R.E. Grove, L.A. Hackel, F.Y. Wu and D.G. Youmans), Proceedings of International Quantum Electronics Conference, June 1974.
26. "Dye Lasers," Optical Engineering, 13, G121, 1974.
27. "Frequency-Stable Jet Stream Dye Laser," (with F.Y. Wu and R.E. Grove), J. Optical Society of America, 64, 553, 1974.
28. "Laser Applications—The Laser Doppler Velocimeter," Optical Engineering, 13, G154, 1974.
29. "Measurement of Natural Lineshape of I₂ Hyperfine Transitions," (with L.A. Hackel and D.G. Youmans), J. Optical Society of America, 64, 1387, 1974.
30. "CW Dye Laser for Ultra-High Resolution Spectroscopy," (with F.Y. Wu and R.E. Grove), App. Phys. Lett., July 1, 1974.

Publications (cont'd)

31. "High-Resolution Holographic Contour Generation with White Light Reconstruction," (with P.D. Henshaw), Optics Communications, September 1974.
32. "Ultra-High Resolution Laser Spectroscopy," Proceedings of the Society of Photo-Optical Instrumentation Engineers, Vol. 49, "Impact of Lasers in Spectroscopy," August 1974.
33. "Precision Measurement of Hyperfine Structure in I_2 ," (with L.A. Hackel and D.G. Youmans), Proc. of the Society of Photo-Optical Instrumentation Engineers, Vol. 69, "Impact of Lasers in Spectroscopy," August 1974.
34. "Molecular Beam Spectroscopy with Lasers," (Invited Paper), Bull. American Physical Society, Vol. 19, No. 10, p. 1182, November 1974.
35. "The Ring Laser," Optical Engineering 13, G217, 1974.
36. "Frequency Stabilization of a CW Dye Laser," (with R.E. Grove and F.Y. Wu), Optical Engineering 13, 531, 1974.
37. "A New High-Resolution Holographic Contouring Method," (with P.D. Henshaw), Proceedings of the Society of Photo-Optical Instrumentation Engineers, Vol. 51, Coherent Optical Processing, August 1974.
38. "Molecular Beam Stabilized Argon Laser," (with L.A. Hackel and D.G. Youmans), Proceedings of Fifth International Conference on Atomic Masses and Fundamental Constants, Paris, France, June 2-6, 1975.
39. "Observation of Magnetic Octupole and Scalar Spin-Spin Interactions in I_2 Using Laser Spectroscopy," (with R.A. Hackel, K.H. Casleton and S.G. Kukolich), Physical Review Letters, 35, 568, 1975.
40. "Magnetic Octupole Interactions in I_2 ," (with K.H. Casleton and L.A. Hackel), Proceedings of Second Laser Spectroscopy Conference, Marseilles, France, June 23-28, 1975 (Springer-Verlag Press).
41. "Sensitivity of Multiloop Sagnac Interferometer and Laser Gyroscope," (with S. Balsamo), Laser Focus, October 1975.
42. "Investigation of the Spectrum of Resonance Fluorescence Induced by a Monochromatic Field," (with F.Y. Wu and R.E. Grove), Phys. Rev. Letters 35, 1426, 1975.
43. "The Stress-Strain Behavior of the Corneal Envelope of the Eye. I. Development of a System for Making in vivo Measurements Using Optical Interferometry," (with R.F. Brubaker, L. Chin, L. Young, S.A. Johnson and G.W. Beeler), Experimental Eye Research 21, 37, 1975.

Publications (cont'd)

44. "Reply to Comment by B.M. Landsberg: Nuclear Hyperfine Splittings in the V-X Electronic Band System of $^{127}\text{I}_2$," (with L.A. Hackel, K.H. Caselton and S.G. Kukolich), Chem. Phys. Letters 43, 104, 1976.
45. "Molecular Beam Stabilized Multiwatt Argon Lasers," (with L.A. Hackel and R.P. Hackel), Proc. of 2nd Symposium of Frequency Standards and Metrology, Copper Mountain, Colorado, July 1976.
46. "Frequency Distribution of Resonance Fluorescence in an Intense Monochromatic Field," (with F.Y. Wu and R.E. Grove), Proc. of 2nd Symposium on Frequency Standards and Metrology, Copper Mountain, Colorado, July 1976.
47. "High Resolution Tunable Laser Spectroscopy," Proc. SPIE Meeting on Unconventional Spectroscopy, San Diego, California, August 1976.
48. "Measurement of the Spectrum of Resonance Fluorescence from a 2-level Atom in an Intense Monochromatic Field," (with R.E. Grove and F.Y. Wu), Phys. Rev. (A) 15, 227, 1977.
49. "Laser Streak Velocimetry for Two-Dimensional Flows in Gases," (with G.W. Sparks Jr.), AIAA Journal 15, 110, 1977.
50. "Wide-bandwidth Feedback Loop Cuts Jitter in Output of Commercial cw Dye Laser," (with F.Y. Wu), Laser Focus, March 1977.
51. "Passive Ring Resonator Laser Gyroscope," (with S.R. Balsamo), Applied Physics Letters, 1 May 1977.
52. "New Approach to Laser Gyroscopes," (with S.R. Balsamo), Proceedings of National Aerospace & Electronics Conference (NAECON), Dayton, Ohio, May 1977.
53. "Molecular Beam Stabilized Multiwatt Argon Lasers," (with L.A. Hackel and R.P. Hackel), Metrologia, 13, 141, 1977.
54. "Measurement of the Emission and Absorption Spectrum of Strongly Driven Two-Level Atoms," (with F.Y. Wu), Proceedings of Vavilov Conference on Nonlinear Optics, Novosibirsk, USSR, June 1977.
55. "New Techniques for High-Sensitivity, High-Resolution Spectroscopy," Proceedings of Vavilov Conference on Nonlinear Optics, Vovosibirsk, USSR, June 1977.
56. Book Review for Physics Today: "Nonlinear Laser Spectroscopy" by Letokhov & Chebotayev, Springer-Verlag, March 1978.
57. "Two-Level Atoms in an Intense Monochromatic Field: A Review of Recent Experimental Investigations," (with F.Y. Wu), in Multiphoton Processes, Editors: J.H. Eberly and P. Lampronponlos, Wiley, 1978.

Publications (cont'd)

58. "Doppler-Free Stimulated-Emission Spectroscopy and Secondary Frequency Standards Using an Optically Pumped Laser," (with J.B. Koffend, S. Goldstein, R. Bacis and R.W. Field), Phys. Rev. Lett., 9 October 1978.
59. "Passive Cavity Optical Rotation Sensor," (with J.A. Cole, J. Harrison and G. Sanders), in "Laser Inertial Rotation Sensors," Editors S. Ezekiel and G.E. Knausberger, Society of Photo-Optical Instrumentation Engineering, Vol. 157, 1978.
60. "Techniques for Shot-Noise-Limited Inertial Rotation Measurement Using a Multiturn Fiber Sagnac Interferometer," (with J.L. Davis) in "Laser Inertial Rotation Sensors," Editors: S. Ezekiel and G.E. Knausberger, Society of Photo-Optical Instrumentation Engineering, Vol. 157, 1978.
61. "Observation of Amplification in a Strongly Driven Two-Level Atomic System at Optical Frequencies," (with F.Y. Wu, M. Ducloy and B.R. Mollow), Phys. Rev. Lett. 38, 1077, 1978.
62. "Observation of Subnatural Linewidths by Two-Step Resonant Scattering in I₂ Vapor," (with R.P. Hackel), Phys. Rev. Lett. 42, 1736, 1979.
63. "Interaction of Two Resonant Laser Fields with a Folded Doppler Broadened System of I₂," (with R.P. Hackel), in Laser Spectroscopy IV, Editors: H. Walther and K.W. Rothe, Springer-Verlag, 1979.
64. "Re-evaluation of the Hyperfine Coupling Constants for B-X Transitions in I₂," (with R.P. Hackel and L.A. Hackel), Phys. Rev. A, 21, 1342, 1980.
65. "Optical Gyroscopes," Proceedings of International Conference on Lasers, Beijing, China, May 1980 (to be published).
66. "High Resolution Spectroscopy of Atoms and Molecules in Monochromatic Optical Fields," Proceedings of International Conference on Lasers, Beijing, China May 1980 (to be published).
67. "Laser Gyroscopes," Proceedings of Sergio Porto Memorial Symposium on Lasers and Applications, Rio de Janeiro, Brazil, June 1980 (to be published by Springer-Verlag).

Biographical Sketch

Edward L. Wright

Address: Room 26-345
Massachusetts Institute of Technology
77 Massachusetts Avenue
Cambridge, MA 02139

Telephone: (617) 253-2571

Birth: August 25, 1947
Washington, D. C.

Citizenship: United States

Education: 1969 Harvard AB, summa cum laude, Physics
1971 Harvard AM, Astronomy
1976 Harvard PhD, Astronomy

Honors and Fellowships:

1968 Phi Beta Kappa Senior Sixteen
1970-1971 G. R. Agassiz Fellowship
1971-1973 National Science Foundation Fellowship
1973-1976 Junior Fellow, Harvard University

Employment: 1966-1969 Programming Assistant at the Harvard
Computer Center (25%)
1969-1970 Physicist at the Naval Research Laboratory,
Acoustics Division
1971-1973 Teaching Fellow in Astronomy (20%)
1976-1980 Assistant Professor of Physics at MIT
1980- Associate Professor of Physics at MIT
1981 Visiting Associate Professor of Astronomy at UCLA

Outside Professional Activities:

1977-1979 Member of the Focal plane Instrument Requirements
and Science Team (FIRST) for the Shuttle InfraRed
Telescope Facility (SIRTF).
1978- Participating Scientist for the COsmic Background
Explorer (COBE) Science Working Group.
1980- Member of the Management Operations Working Group
for Airborne Astronomy at NASA.

- "The 8-13 Micron Spectrum of NGC 1068," F. C. Gillett, D. E. Kleinmann, and E. L. Wright, Bull. AAS, 2, 436.
- "Flight Performance of the 102-cm Balloon-Borne Far-Infrared Telescope," G. G. Fazio, E. L. Wright, and F. J. Low, Bull. AAS, 2, 408.
- "G45.5+0.1 and G45.1+0.1: Compact Infrared Sources," M. Zeilik II, D. E. Kleinmann, and E. L. Wright, Ap.J., 199, 401.
- "High Resolution Map of the W3 Region at Far-Infrared Wavelengths," G. G. Fazio, D. E. Kleinmann, R. W. Noyes, E. L. Wright, M. Zeilik II, and F. J. Low, Ap.J.(Letters), 199, L177.
- "Optical Studies of UHURU Sources. XII: The Light Curve of Sco X-1 = V818 Sco, 1889-1974," E. L. Wright, E. W. Gottlieb, and W. Liller, Ap.J., 200, 171.
- "Observations of M82 and NGC 253 at 8-13 Microns," F. C. Gillett, D. E. Kleinmann, E. L. Wright, and R. W. Capps, Ap.J.(Letters), 198, L65.
- 1974 "Optical Studies of UHURU Sources. XI: A Probable Period for Scorpio X-1 = V818 Sco," E. W. Gottlieb, E. L. Wright, and W. Liller, Ap.J.(Letters), 195, L33.
- "High Resolution Maps of H II Regions at Far-Infrared Wavelengths," G. G. Fazio, D. E. Kleinmann, R. W. Noyes, E. L. Wright, M. Zeilik II, and F. J. Low, Proceedings of the Eighth ESLAB Symposium, pp 79-85.
- "A Balloon-Borne 1-Meter Telescope for Far-Infrared Astronomy," G. G. Fazio, D. E. Kleinmann, R. W. Noyes, E. L. Wright, and F. J. Low, Proceedings of the Symposium on Telescope Systems for Balloon-Borne Research, NASA Ames Research Center, NASA TM X-62, 397, pp. 38-50.
- "Search for Optical Emission from Cosmic Gamma-Ray Bursts," J. E. Grindlay, E. L. Wright, and R. E. McCrosky, Ap.J.(Letters), 192, L113.
- "Infrared Photometry of Comet Kohoutek," M. Zeilik II, and E. L. Wright, Icarus, 23, 577.
- "10-Micron Observations of Southern Hemisphere Galaxies," D. E. Kleinmann and E. L. Wright, Ap.J.(Letters), 191, L19.
- "A High Resolution Map of the Orion Nebular Region at Far-Infrared Wavelengths," G. G. Fazio, D. E. Kleinmann, R. W. Noyes, E. L. Wright, M. Zeilik II, and F. J. Low, Ap.J.(Letters), 192, L23.
- "High-Resolution Maps of the Orion Nebula Region and W3 at Far-Infrared Wavelengths," G. G. Fazio, D. E. Kleinmann, R. W. Noyes, E. L. Wright, M. Zeilik II, and F. J. Low, Bull. AAS, 6, 329.
- "Helium Abundance at the Galactic Center," M. Jura and E. L. Wright, Ap.J., 188, 473.
- 1973 "A New Infrared Source in M17," D. E. Kleinmann and E. L. Wright, Ap.J.(Letters), 185, L31.
- "Infrared Brightness Distributions of Dusty H II Regions," E. L. Wright, Ap.J., 185, 569.
- "Collision Induced Absorption in Alkali-Metal-Atom Inert-Gas Mixtures," C. Bottcher, A. Dalgarno, and E. L. Wright, Phys.Rev.A, 2, 1606.
- 1972 "Infrared Emissivities of H₂ and HD," A. Dalgarno and E. L. Wright, Ap.J.(Letters), 174, L49.
- 1971 "The Collision Induced Absorption of Hydrogen and Helium," E. L. Wright, Bull. AAS, 3, 482.
- 1970 "Ray Tracing with Horizontal and Vertical Gradients," E. L. Wright, JASA, 48, 92.
- 1969 "Probability Density Functions of n Vectors Added with Random Directions," E. L. Wright, NRL Report 6922.

STONE & WEBSTER ENGINEERING CORPORATION



245 SUMMER STREET, BOSTON, MASSACHUSETTS

ADDRESS ALL CORRESPONDENCE TO P.O. BOX 2325, BOSTON, MASS. 02107

W. U. TELEX: 94-0001
94-0977

BOSTON
NEW YORK
CHERRY HILL, N.J.
DENVER
CHICAGO
HOUSTON
PORTLAND, OREGON
SAN DIEGO
WASHINGTON, D.C.

DESIGN
CONSTRUCTION
REPORTS
EXAMINATIONS
CONSULTING
ENGINEERING

March 27, 1981

Professor Rainer Weiss/
Scientist Paul S. Lindsay
Department of Physics, Room No. 20F-001
Massachusetts Institute of Technology
Cambridge, MA 02139

W.O. 528.382.1

Dear Sirs:

NATIONAL SCIENCE FOUNDATION
PROPOSAL FOR "INTERFEROMETRIC
BROAD BAND GRAVITATIONAL ANTENNA"

We appreciate the opportunity to have discussed with you, in greater detail than previously, the project requirements and possible project schedule to support your NSF proposal on gravitational wave detection and measurement. Based on these discussions we understand that the Conceptual Design (Phase 1) would consist of several Tasks and Sub-Tasks that would be scheduled over approximately a three-year period. Task 1, which would cover the design and operational requirements, would be undertaken almost entirely by MIT and cover a period of about a year. Our involvement would essentially commence on Task 2. This Task would undertake, as a sub-task, the important trade-off studies (cost vs technical feasibility and constructability) of the vacuum system, laser beam enclosure and other design considerations. Stone & Webster (S&W) would participate with MIT and Arthur D. Little (ADL) in accomplishing the trade studies. Other Task 2 Sub-Tasks would cover conceptual design sketches and site arrangement drawings and a conceptual design estimate all of which would be coordinated by S&W. The Phase I effort would be completed by accomplishing Task 3, the Phase I Conceptual Design Report, which would be undertaken by MIT with contributions as necessary by S&W and ADL.

We understand a Phase II effort would be contingent on the results of the Phase I effort and NSF funding. Phase II would involve detailed design, construction, start-up and testing. S&W would have major involvement in Phase II, which might cover a period of 2 1/2 to 4 years.

Stone & Webster agrees to support the Massachusetts Institute of Technology as a Sub-Contractor in Phases I and II. We propose to provide our services on a cost-reimbursable basis. Approved or provisional Government overhead rates will be used and our fee will be consistent with the type and value of services provided. Specifics of our scope-of-work, level of effort, expected cost, type of contract, and terms and conditions are to be negotiated.

We would expect to assign this work to our Advanced Technology Section where it would be handled by senior engineers or scientists experienced in a variety of similar projects and studies. Typical of the qualifications of staff we would assign are Dr. George East, Mr. Robert DeLuca and Mr. Robert Tschirch who would work under the direction of Mr. Donald Guild, Head of the Advanced Technology Section. Resumes of these individuals are attached for your information.

As you are aware, Stone & Webster and MIT have a long history that includes joint involvement in numerous projects. As a major international firm we are probably best known for the larger chemical, hydroelectric, fossil and nuclear power plants that we have successfully designed and constructed; we also have substantial experience in the design and construction of a variety of smaller projects that were very complex in the design and construction challenges that we successfully resolved. Attached is a general capabilities brochure that describes some of the conventional type of projects where we were involved as well as our most recent Annual Report. Also attached are copies of a work schedule that we prepared to reflect the schedule and involvement of our effort as you described it to us.

Should you have further questions, please contact Don Guild (617/973-2501), Paul Riegelhaupt (617/973-0954), or our Manager of Government Marketing, Robert Paine (617/973-0060).

Very truly yours,

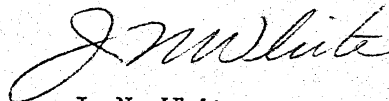

J. N. White
Vice President

- Encl. - Resumes (20 ea)
- Brochures (20 ea)
- Schedule (20 ea)

DONALD H. GUILD

EDUCATION

University of Massachusetts - BSME
Northeastern University - MBA
Rensselaer Polytechnic Institute
Miami University (Ohio)

LICENSES AND REGISTRATIONS

Professional Engineer - Massachusetts

PROFESSIONAL AFFILIATIONS

American Society of Mechanical Engineers - Member
ASME Gas Turbine Division - Electric Utilities Committee -
Past Chairman
International Solar Energy Society - Member
American Solar Energy Society

PUBLICATIONS

"Projected Growth of Electric Power Generation Facilities in the United States Through the Year 2000" - Master's Thesis - 1959
"The Economics and Use of Large Scale Electrodialysis Plants on Selected Tidal Estuarial Waters" - Office of Saline Water, Washington - 1969
"A Low Energy Concept for the Manufacture of Fresh Water from the Sea" - American Chemical Society - 1970
"Technical and Economic Features of Stone & Webster's FAST Combined Cycle Power Plants" - American Power Conference - 1971
"Actual Case Studies of the Economics of Heating Boiler Feed-water Using Linear Focusing Solar Collectors" - International Solar Energy Society - 1978

EXPERIENCE

Mr. Guild is currently Head of Stone & Webster's Advanced Technology Section with active responsibility as Project Manager on several projects. As Program Manager, he supervises a group of approximately 100 engineers, designers, and specialists representing various technical disciplines and interests. Current projects under his direction involve various types of solar electric power generation, atmospheric and pressurized fluid bed combustion, advanced nuclear power generation, coal-fired and coal-water mixtures, fuel cells and thermionic power generation. Completed projects have included other areas of interest such as desalination and combined cycle power plants.

Mr. Guild has been with Stone & Webster Engineering Corporation since 1955 and has broad experience in the design of both fossil fuel-fired and nuclear power plants. He has served as Project Manager



or major Project Engineer on several projects. He also served as Supervisor of the Studies Group in the Power Division where he directed complex studies on various energy applications. Detailed site evaluation reports and conceptual and preliminary design studies of fossil and nuclear plants have been prepared under his direction.

Several technical papers have been written and presented by Mr. Guild before ASME, AIChE and at DOE conferences.

Previous to joining Stone & Webster, he did responsible engineering work in industrial cryogenic and high vacuum applications as Project Engineer for a large industrial consulting firm.



ROBERT A. DELUCA

EDUCATION

Lowell Institute Mechanical Engineer
Advanced Machine Design, Advanced Mathematics 2 years
Industrial Chemistry International Correspondence Schools -
1 year
Stone & Webster Utility Management Training Course

LICENSES AND REGISTRATIONS

Registered Professional Engineer - Massachusetts

PROFESSIONAL AFFILIATIONS

ASME Member
Pressure Vessel Research Committee

PATENTS

Automatic carton cell assembling machine
Fast bubble cap fastener
Automatic digester

EXPERIENCE SUMMARY

Mr. DeLuca is a Senior Mechanical Engineer in the Engineering Mechanics Division. He has extensive background in mechanical design and stress analysis. His work in these areas has been outstanding and he has been used as a consultant by all divisions of our Engineering Department. This work has been of a specialized nature in stress analysis and design of plate and shell structures, and of special machinery associated with the paper industry and nuclear power plants.

During his professional career, Mr. DeLuca has had overall responsibility for the design and selection of fabricators for all pressure vessels required by the Chemical Division. He designed many of the structural components and systems for the nuclear power plant at Shippingport, Pennsylvania and the automatic digester for Great Northern Paper Company. At Great Northern he supervised the installation of the digester hydraulic system.

He also designed the 140 ft, 3 centimeter band radio telescope of the Radio Observatory at Green Bank, West Virginia, and the reactor containment structures and major structural components for Yankee Rowe, Connecticut Yankee, and numerous other major nuclear plants.

Prior to joining Stone & Webster, he had three years experience in the design of marine heat exchangers, boilers, turbines, and propulsion drives.



GEORGE H. EAST, JR.

EDUCATION

Massachusetts Institute of Technology - B.S. in Mechanical Engineering
M.S. in Mechanical Engineering
Ph.D. in Mechanical Engineering (Materials)

LICENSES AND REGISTRATIONS

Professional Engineer - Massachusetts

Patents

U.S. Patent No. 4,080,898, Energy Absorbing Pipe Restraints
U.S. Patent No. 4,101,117, Impact Energy Absorbing Pipe Restraints
U.S. Patent No. 4,101,118, Impact Energy Absorbing Pipe Restraints

PUBLICATIONS

A. S. Argon and G. H. East, Jr., The Microyield Strength of Beryllium Iron Alloys, TMS AIME, Vol. 239 (April 1967), p. 598-9

A. S. Argon and G. H. East, Jr., A Statistical Theory for Easy Glide, Transactions of the Japan Institute of Metals, Supplement (1968)

G. H. East, Jr., Some Hints for Photographers of Total Solar Eclipses, Sky and Telescope, Vol 45 (May 1973), p 322-5

S. D. Pirotin and G. H. East, Jr., Large Deflection, Elastic-Plastic Response of Piping: Experiment, Analysis and Application. Transactions of the 4th International Conference on Structural Mechanics in Reactor Technology, Commission of the European Communities, Brussels, 1977, paper F-3/1

J. M. Peech, R. E. Roemer, S. D. Pirotin, G. H. East, and N. A. Goldstein, Local Crush Rigidity of Pipes and Elbows, Transactions of the 4th International Conference on Structural Mechanics in Reactor Technology, Commission of European Communities, Brussels, 1977, paper F-3/8

A. S. Argon and G. H. East, Forest Dislocation Intersections in Stage I Deformation of Copper Single Crystals, 5th International Conference on the Strength of Metals and Alloys, Aachen, Germany, August 1979.

COMMITTEE

American Nuclear Society - ANS 58.2 Working Group for Protection of Nuclear Power Plants Against Pipe Rupture - Member

EXPERIENCE SUMMARY

Dr. East joined Stone & Webster Engineering Corporation in March 1971 as an Engineer in the Nuclear Division and is now a Section Head in the Engineering Mechanics Division.

Upon joining the Company, Dr. East was assigned to the Analysis Section of the Mechanical Group. In November 1971, he became Lead Engineer for Special Projects in the Mechanical Section. He was appointed Assistant Supervisor for Pipe Rupture in August 1974, which added responsibility for the design of pipe whip restraints and jet impingement shields to his existing responsibility for analysis. He became a Supervisor in the Mechanical Section in January 1977, with added responsibility for mechanical equipment and for the evaluation of turbine missiles and internally generated missiles. He was appointed Section Head in April 1980 and is now responsible for the technical quality of all Mechanical Section work and for the training and assignment of all Mechanical Section engineering and design personnel.

Prior to joining Stone & Webster, Dr. East conducted basic and applied research in material behavior at the Massachusetts Institute of Technology.



ROBERT E. TSCHIRCH

EDUCATION

Yale University - B.E.

PROFESSIONAL AFFILIATIONS

American Society of Mechanical Engineers - Member
American Society of Mechanical Engineers in Sub Group
on Fabrication and Examination of Section III, Nuclear
Components, of the ASME Boiler and Pressure Vessel Committee

LICENSES AND REGISTRATIONS

Professional Engineer - Massachusetts and Rhode Island

EXPERIENCE SUMMARY

Mr. Tschirch is a Mechanical Engineer with extensive experience in shop fabrication and field erection of power plant piping, both nuclear and fossil fuel. This experience together with his knowledge of Piping Codes and Standards has been of significant value in his assignment as a Piping Specialist concerned with the preparation of piping specifications. His career, prior to joining the Stone & Webster Engineering Corporation, includes several years of successful performance in administration and management.



Arthur D. Little, Inc. ACORN PARK · CAMBRIDGE MA 02140 · (617) 864-5770 · TELEX 921436

16 March 1981

Dr. Rainer Weiss

20F 001

Massachusetts Institute of Technology
Cambridge, MA 02139

Dear Ray:

92912

This is to confirm our telephone conversation of today, and to transmit the attached Arthur D. Little, Inc., qualifications to support your study program on the prototype (full scale) gravitational antenna. The qualifications contain examples of relevant experience plus resumes of staff members who could participate in the study. The specific areas of our study, and the concentration in these areas would determine who would participate, and to what degree.

I believe we can make the best contribution to your study in two areas: Construction Strategy and Optics. In these areas, we would assist the MIT team in generating the conceptual design of the structural/vacuum system and the optical system. In the construction Strategy area, this would consist of performing technical and/or technical/cost tradeoffs in the areas of mechanical and thermal design, vibration isolation, material selection, and vacuum pumping system design. In the optics area our support could include an engineering design comparison of the optical interferometer approaches including laser source characteristics, point accuracy, beam diameters, sensing mechanisms, delay line configuration, and/or other optical problems which you feel need consideration in the engineering design portions of the study. Specific tasks, and their scope would be mutually agreed upon during the course of the study. We would also be willing to cooperate with any other subcontractors on your project whose areas of participation interfaced with our areas.

We look forward to the possibility of working with you on this project, and would be pleased to submit a proposal to you at an appropriate time. Please call me if you would like further information.

Very truly yours,



R. Warren Breckenridge

RWB:rsd

Encl. (2 sets)

CAMBRIDGE MASSACHUSETTS

ATHENS BRUSSELS LONDON MADRID PARIS RIO DE JANEIRO SAN FRANCISCO SAO PAULO TOKYO TORONTO WASHINGTON WIESBADEN

Arthur D. Little, Inc.

GEORGE O. REYNOLDS

Mr. Reynolds is a staff member of the Electronic Systems Section, Optics and Instrumentation Unit. His areas of expertise include optical physics, fiber optical communication systems, electro-optical instrumentation, holography, photographic systems, medical optics and interferometry.

Since joining Arthur D. Little Mr. Reynolds has been involved in studies and projects dealing with:

- wavelength division multiplexing analysis for a fiber optical communication system,
- image synthesis utilizing interferometry with incoherent sources,
- image analysis for both optical and ultrasonic imaging systems,
- applications of optics in medicine,
- optical diagnostic techniques for combustion processes,
- storage of digital information on film,
- optical data processing and scanning systems,
- impact of fiber optic transmission on CATV systems,
- scanning interferometer for measuring optical phase,
- imaging through human cataracts utilizing holography,
- non-invasive velocity measurements with laser doppler anemometry,
- performed technical evaluations and market surveys on fiber optic components,
- performed a study on optical switches and taps for fiber optic telephone network, and
- fiber optic intrusion detection alarm system.

Prior to joining ADL, Mr. Reynolds was Director of Optical Sciences, Aerodyne Research, Inc., Bedford, Massachusetts, and Director of Applied Sciences Department, Technical Operations, Inc., Burlington, Massachusetts.

Mr. Reynolds holds B. Sc. and M. Sc. degrees in physics from the University of New Hampshire, Durham, New Hampshire, and holds memberships in the Optical Society of America (Fellow); American Physical Society; New England Section, Optical Society of America (Past Member Executive Council); Sigma Xi; IEEE; Society of Photo Optical Instrumentation Engineers (Fellow); and the Combustion Institute.

Mr. Reynolds is co-author of "Theory and Applications of Holography," Addison Wesley (1967), and the author of many technical publications and patents on optical systems, holography, coherent optics, interferometry, phase contrast microscopy, image analysis, holographic interferometry, displays, scanning systems, data storage and retrieval techniques, synthetic aperture optics, and fiber optic communication systems.

In addition, Mr. Reynolds is adjunct professor, Electrical Engineering Department, Northeastern University; associate editor of "Optical Engineering," was a lecturer for a U.C.L.A. extension course on optics and holography, and was a lecturer in the short course "Fiber Optic Communications Systems", sponsored by the Boston Section of the IEEE.

DAVID W. ALMGREN

B.S.E., Basic Engineering, Princeton University, 1957
S.M., Mechanical Engineering, MIT, 1961
Mech. E., Mechanical Engineering, MIT, 1966
Ph.D. Heat Transfer, MIT, Cryogenic Eng. Lab., 1966

Dr. Almgren heads the Engineering Systems Unit at Arthur D. Little, Inc., where his work is largely devoted to the computerized analysis of engineering systems, to the design and implementation of thermal systems on orbiting payloads and to consulting services on special heat transfer problems.

For NASA GSFC, Dr. Almgren conducted a survey of thermal design engineers in the government and in major aerospace companies to determine the future requirements of the analysts in the era of the shuttle. The major impacts of shuttle operations on thermal design engineers are: (1) the lower levels of funding per mission to support the analyses, (2) the shorter time between the many individual missions in which to perform the thermal design analyses, and (3) the complex thermal interactions between many payloads in the cargo bay for any one mission. A need for a simple and flexible thermal analysis software system was identified and Arthur D. Little, Inc., was chosen to develop the program. The program is now in use at NASA GSFC, NRL, and in Europe for shuttle payload thermal analysis.

Dr. Almgren has been managing an in-house effort at Arthur D. Little, Inc., to design and fabricate a Modular Thermal Control System for Shuttle payloads. This hardware system utilizes a liquid loop, driven by a positive displacement pump, to thermally couple a payload to a heat rejection radiator. This reusable system is being offered as a modular, low cost thermal control system to the community of Shuttle users.

For the Naval Research Laboratory, he headed the effort to define and implement the thermal control subsystem for their second Navigation Technology Satellite (NTS-2). This spacecraft is carrying the state-of-the-art NiH₂ batteries and cesium beam frequency standards both of which require accurate temperature control. Currently, Dr. Almgren is leading the effort to define a preliminary thermal design for NTS-3 based upon the successful design of NTS-2.

For NASA GSFC, he was responsible for an effort to define the programmatic and technical requirements for a joint USA/ESA heat pipe test facility to be flown on Spacelab. This effort included many personal interviews with potential U.S. principal investigators to obtain their views on the best utilization of a 0-g test facility and resulted in specific recommendations to NASA as to which type of heat pipe experiments would be initially funded.

For NASA's Orbiting Astronomical Observatory (OAO) Program, Dr. Almgren had responsibility for the thermal design analyses and testing of the primary optical experiment packages on three spacecraft. In addition to his responsibilities associated with the OAO program, Dr. Almgren supervised a team of thermal, structural, and optical analysts at ADL to assist NASA GSFC with its initial studies on the Large Space Telescope (LST) Program. This work involved the integration of the thermal, structural, and optical analyses so that, for a given thermal design configuration, the resulting optical performance of the system could be determined.

David W. Almgren Continued

For NASA's Orbiting Solar Observatory (OSO) Program, he provided the project team with an independent assessment of the thermal/structural/optical design of Colorado University's pointing instrument. This work included the development of detailed thermal, structural, and optical models of the instrument plus verification of these models with test data. For the CNRS pointed instrument, Dr. Almgren defined and monitored the thermal vacuum test, conducted in France, that was utilized to verify the thermal design of the instrument under predicted worst case orbital thermal conditions.

For the Solar Power Satellite (SPS) Program, Dr. Almgren has been managing the effort to evaluate the impact of new photovoltaic material developments on the technical and economic feasibility of the project. As part of this effort, it was necessary to assess current and projected production techniques for proposed solar cells and to define the industrial infrastructure that would be required to support the manufacture of the solar cell arrays in the desired quantities.

Dr. Almgren has also provided thermal design consulting services to several European agencies including the Space Research Laboratory in Utrecht, the Netherlands, and to CNRS and ONERA located just outside Paris, France.

In addition to his analysis of orbiting, optical payloads, Dr. Almgren has been involved in the analysis and computer simulation of the heat flow in penetrations through multilayer insulation systems, in the thermal analysis of experiment packages on the lunar and Martian surfaces, and in the computer simulation of several Stirling cycle cryogenic refrigerators, and in the computer simulation of more energy efficient air conditioning units.

He is a member of Sigma XI, the American Society of Mechanical Engineers, the American Institute of Aeronautics and Astronautics, and is a Registered Professional Engineer in the Commonwealth of Massachusetts.

R. WARREN BRECKENRIDGE

Mr. Breckenridge graduated (with distinction) in 1955 from Cornell University with a Bachelor of Mechanical Engineering degree.

Upon graduation, Mr. Breckenridge worked at the Engineering Laboratory of the Linde Division of Union Carbide Corporation. His work encompassed the design, development, and installation of large air separation plants. Subsequently, he worked as an industrial engineer in a jobbing machine shop, where he was responsible for industrial engineering and production control.

Since joining Arthur D. Little, Inc., in 1960, Mr. Breckenridge has had technical and managerial responsibilities in a number of design and development programs. Most of these programs have involved heat power and fluid handling systems. His work has encompassed the technical disciplines of thermodynamics, heat transfer, fluid dynamics, applied mechanics, and machine design. Most of this work has involved the design and development of cryogenic storage equipment and closed cycle cryogenic refrigerators for spaceborne applications.

Mr. Breckenridge has participated in design studies on the storage of cryogenic propellants in space, and has directed several design studies on spaceborne cryogenic storage systems. He has also led development programs on liquid helium and liquid nitrogen storage dewars.

Most of his recent work has been in the area of closed cycle, cryogenic refrigeration systems. He has participated in design studies of refrigerators using the Stirling, Vuilleumier, Joule-Thomson, and Brayton cycles. Mr. Breckenridge has managed a number of design studies and development programs on rotary reciprocating refrigerators. These advanced technology cryogenic refrigerators have been developed at Arthur D. Little, Inc., for providing cryogenic refrigeration on long-term space missions. They are free piston devices which incorporate reciprocating compressors and expansion engines, self-acting gas bearings, gas springs, electromagnetic linear actuators, and solid state electronic power conditioning and control equipment.

Mr. Breckenridge has published a number of papers and reports on cryogenic refrigeration systems and components. He is a member of Tau Beta Pi and the American Society of Mechanical Engineers, and is a registered professional engineer in New York and Massachusetts. He holds one U.S. Patent.

In 1975 Mr. Breckenridge attended the Program for Senior Executives at the Alfred P. Sloan School of Management of the Massachusetts Institute of Technology. He is the Unit Manager of the Thermo-Mechanical Systems Unit in the Engineering Sciences Section of Arthur D. Little, Inc.

Arthur D. Little, Inc.

BERNARD C. HANLEY

Mr. Hanley received his B.S. in General Engineering from the University of Illinois in 1941 and his M.S. in Theoretical and Applied Mechanics from the University of Illinois in 1949.

Prior to joining Arthur D. Little, Inc., Mr. Hanley was employed by General Electric Company (1941-1944). There he worked in the design and development testing of steam turbines. He completed General Electric's Advanced Course in Engineering.

Following two years of active duty as an officer in the Naval Reserve, Mr. Hanley was Special Research Associate at the University of Illinois, working on basic research in fatigue of metals. From 1949-1955, Mr. Hanley was Research Scientist at the Oklahoma Power and Propulsion Laboratory where he was responsible for testing and analysis of test data for tests for reduced specific fuel consumption of two air-cooled engines for Army Ordnance. He also assisted in the design research on basic design of compound engines and tests on fuel injection engines.

While at Arthur D. Little, Inc., Mr. Hanley has assisted in the design and stress analysis of piping and pipe supports for the propellant loading system for the Atlas, Thor, and Titan missiles. He was responsible for the design of the liquid nitrogen dewars for the XB70 fuel tank inerting systems. He prepared the Quality Control Manual which was approved for delivery of equipment to the Air Force. He was consultant to the Boeing Company for cryogenic tankage for Dyna Soar. He was the project engineer on the cryogenic aspects of the modification to Test Cell C at the Nuclear Rocket Development Site, Mercury, Nevada, where two tanks for storage of 1,000,000 gallons of liquid hydrogen were installed and connected to the high pressure pump. He was project engineer on the design of the seals, lift and move-in, and traverse equipment for Doors 3, 4, and 5, NASA Aluminum Test Chamber at Plumbrook Station. Mr. Hanley designed the ducting, supports, and foundations for connecting the intakes and exhausts to large shock tubes for two 6,000 HP prime mover-generator sets. He also designed the ducting and support system for the particulate and SO₂ removal system for a large power station installation. He was the project engineer on the development and testing of a fluid-bearing rocket test stand and calibrator; review of Kaiser Engineers design of propellant loading system at Pr. Arguello, California; development of a wear equation for lubricated roller chains; and brazing and welding investigation on pressure vessels. He designed four high pressure crystal-growing furnaces to ASME Code requirements. He was Configuration Manager on four ALSEP hardware programs for NASA, and assisted in the mechanical design in two of these programs. Mr. Hanley is active in the EPRI-sponsored Residential project for solar-assisted load-managed heating and cooling of ten residences. He is also participating in the EPRI-sponsored Heat Storage project, particularly in the room ceramic installations.

Mr. Hanley has written papers on effect of size of specimen on fatigue strength and effect of range of stress and state of stress on fatigue strength. He has co-authored a section on "Effect of Surface Finish on Fatigue," ASME Metals Engineering - Design Handbook; 1st Edition, 1953, 2nd Edition, 1965. Mr. Hanley holds three U.S. patents.

Mr. Hanley is a Registered Professional Engineer in the States of Nevada and Massachusetts.

THOMAS E. HOFFMAN

Thomas E. Hoffman has rejoined Arthur D. Little as a member of the Engineering Sciences Section where he will be working on engineering projects related to float zone processing of materials in space, spaceborne cryogenic refrigeration systems and development of other space and Earth-based systems. He was originally at Arthur D. Little from 1957 to 1964 as a group leader in mechanical design at which time he was responsible for the design of the first closed-cycle liquid-helium refrigeration systems, other cryogenic devices and equipment, high-pressure hydraulic pumps, servo-valves, actuators and control system components, and many other items of a mechanical and electro-mechanical nature.

After leaving Arthur D. Little, Mr. Hoffman served fourteen years as head of the Engineering Department of the Smithsonian Astrophysical Observatory in Cambridge, Massachusetts. While there, he was a primary participant in the establishment of a mountain top observatory in southern Arizona having engineering responsibility for roads, services, facilities, buildings, and all scientific instrument and equipment design, procurement, and installation. These latter included a 10 meter-diameter optical collector; satellite-ranging equipment consisting of a pulsed ruby laser combined with a 20 inch diameter photoreceiver and conventional astronomical telescopes of 12, 24, and 60 inch diameter aperture. He also served as Project Engineer from conception through design, fabrication, installation, assembly and start-up of the very successful Multiple Mirror Telescope (MMT) which is a pioneering, unique low-cost, multi-mirror configuration and the world's third largest optical telescope. In addition, while at the Smithsonian, he was significantly involved in numerous space-oriented projects including Telescope (four ultraviolet telescopes aboard OAO-1), LAGEOS (a large passive laser-ranging satellite), and Gravity Probe A (a hydrogen maser experiment observing the red shift inherent in the general theory of relativity), and the design and development of numerous mechanical, electrical and optical instruments and devices.

Mr. Hoffman received his B.S. degree from the University of Rochester in 1950 and his M.S. and Professional M.E. degrees from MIT in 1951 and 1954. While at MIT and until joining ADL in 1957, he worked at their Dynamic Analysis and Control Laboratory on mechanical, electrical, and hydraulic control systems dynamics and associated component design and development. He is a registered professional engineer in both Massachusetts and Arizona, has been issued several patents and has written and published in his several fields.

Arthur D. Little, Inc.

ROBERT M. LUCAS

Mr. Lucas received his B.S. in Mechanical Engineering from the Massachusetts Institute of Technology, and attended the USAF School where he studied electronics and communications. He received his M.S. in Mechanical Engineering, with a major in Applied Mechanics. He joined the staff of Arthur D. Little, Inc., following two years of service with the U.S. Air Force, during which time he worked on the testing and evaluation of guided missiles.

Mr. Lucas has been responsible for the design, engineering, and test of a shock and vibration isolation system for a man-rated lunar experiment for the Apollo Program. This Lunar Heat Flow experiment consisted in part of two pairs of sensitive thermal measuring probes which withstood the launch, trans-lunar and lunar landing environment as well as the astronaut handling. He was also responsible for the stress analysis and mechanical environment testing of the Laser Ranging Retro-Reflectors which were placed on the lunar surface during several Apollo missions. Vibration analysis and testing of orbital spacecraft flight hardware and the packaging of components for transportation environments also have been accomplished.

He has performed stress analyses of reinforced plastics, filament-wound structures in particular, truss-reinforced concrete, laminated wood products and an analysis of minimum weight structural plates for impact loads. He is experienced in the analysis of strain and stresses by the photoelastic technique and other experimental methods. He has also analyzed the stresses and strains in reinforced plastic insulating foams for cryogenic service, plastic liners for concrete pipe, thin metal-plastic laminates, printed circuit boards, and plastic pumps for corrosive media.

A portion of his work at ADL has been in the field of acoustics. He has performed vibration and acoustic measurements of both reciprocating and rotating machines and components for the purpose of noise and vibration reduction.

Another activity has included the design, construction, testing and field deployment of a deep-hole tiltmeter system developed under a contract with ARPA and AFOSR. The down-hole tool, installed and operated in a 2,000-foot borehole on the San Andreas Fault, was designed for use at pressures up to 5,000 psi and temperatures up to 125°C, corresponding to depths of 10,000 feet.

Most recently, Mr. Lucas has carried out failure analyses and associated testing on hardware and components used by the gas and electric utilities.

Within ADL, Mr. Lucas acts as an internal consultant in the applied mechanics areas of dynamics, statics, strength of materials, behavior of structures, and the design of mechanical test equipment.

Mr. Lucas is a member of the ASME and a Registered Engineer in the Commonwealth of Massachusetts.